

# GBS FILING SOLUTIONS

Filing Solutions to meet your everyday needs.

## NEW Short Run Folder Customization!

Now you can economically custom print or personalize a small number of folders.



A TAB Brand

[shopgbsfiling.com](http://shopgbsfiling.com)

888.822.9777

**FOLDERS ..... 3-19**

Ames Match Manila Folder .....6  
 Barkley Match Manila Folder .....6  
 Color Banded Folders .....6  
 Color Folders ..... 6, 15, 17, 19  
 Color Stripe Folders ..... 15, 17  
 Expansion Folders .....5  
 Expansion Pockets .....13-14, 18, 19  
 Jeter Match Folders ..... 12  
 Kardex Match Folders ..... 8-12  
 Manila Folders ..... 4-5, 12, 19  
 Pocket Folders ..... 7, 16, 17, 20  
 TAB Match Folders, Pockets & Jackets..... 15-19  
 Top Tab folders..... 19  
 X-Ray Jackets ..... 16

**ACCESSORIES ..... 20-22**

Bonded Fasteners .....21  
 Conversion Tabs .....22  
 Convertor .....22  
 Extension Clips .....21  
 Polypropylene Pockets .....20

**NETLABELS 3.0 ..... 23-24**

**COLOR CODED STRIP LABELS ..... 25**

**X-RAY JACKETS ..... 26-27**

**PRESSBOARD & CLASSIFICATION FOLDERS ..... 28-29**

**LABELS ..... 30-46**

Alphabetic Labels ..... 31-37  
 Color Control Labels..... 31  
 Competitive Match Labels..... 33-46  
 Create-a-Tab.....46  
 Medical Labels ..... 45  
 Name Labels ..... 46  
 Numeric Labels ..... 32, 38-42  
 Solid Color Labels..... 45-46  
 Year/Month Labels ..... 32, 43-44

**DIVIDERS & INDEXES ..... 47-49**

**OUTGUIDES ..... 50-51**

Vinyl Outguides .....51  
 In-Sight Outguides .....51



**Save time and money by printing your own color-coded file labels.**

## Why NetLabels 3.0?

### NetLabels is easy.

Print labels in three simple steps: select the design, enter or import your data, and click "print".

### NetLabels is flexible.

It runs on any internet-connected computer with any popular browser and a standard color office printer.

### NetLabels is secure.

Sensitive data never leaves your computer.

### NetLabels Features:

- Color-match letters or numbers to any popular labeling system
- Print text such as names or account numbers on both sides of the label, for quick identification.
- Use highlights to emphasize important text print color bands or year codes to quickly identify specific types of files
- Automatically generate barcodes for file tracking

## Learn more:

**800-873-4427**

**NetLabels.com**

Products Manufactured in America



## Filing Solutions to meet your everyday needs

It is important to choose the correct folder based on functionality. A variety of stock weights and constructions are available to insure the folder you choose will perform for the lifetime of your file. We also offer a variety of expansions to accommodate files that become bulky.

Expansion pocket folders and pressboard folders can be used when you require expansion and extra durability. You can also incorporate color into your selection to match decor or signify file type.

Custom printing can be done to your specifications and is economical even for small runs.

To discuss folder customization please call #888-822-9777 or email [csquotes@tab.com](mailto:csquotes@tab.com).





**A Letter Size • Manila • 12¼" W x 9½" H**

MODEL NO.	DESCRIPTION	CARTON QTY	CARTON WT.
8683	11 Pt. Letter Size • Single Ply Tab	500	44 Lbs.
8685	14 Pt. Letter Size • Single Ply Tab	400	44 Lbs.
8668	18 Pt. Letter Size • Single Ply Tab • Full End Tab	250	33 Lbs.
8687	11 Pt. Letter Size • Reinforced Tab	500	50 Lbs.
8688	14 Pt. Letter Size • Reinforced Tab	250	32 Lbs.



**B Letter Size • Manila • Single Ply Tab • 9" Front • 12¼" W x 9½" H**

MODEL NO.	DESCRIPTION	CARTON QTY	CARTON WT.
8683-9	11 Pt. Letter Size • 9" Front	500	44 Lbs.
8685-9	14 Pt. Letter Size • 9" Front	400	45 Lbs.



**C Letter Size • Manila • 12¼" W x 9½" H**

MODEL NO.	DESCRIPTION	CARTON QTY	CARTON WT.
9185	14 Pt. Letter Size • Single Ply Tab	400	45 Lbs.
9187	11 Pt. Letter Size • Reinforced Tab	350	34 Lbs.
9188	14 Pt. Letter Size • Reinforced Tab	250	32 Lbs.

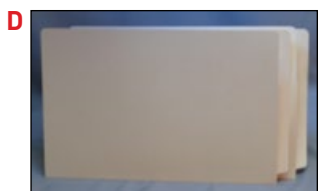

**D Legal Size • Manila • 15¼" W x 9½" H**

MODEL NO.	DESCRIPTION	CARTON QTY	CARTON WT.
8684	11 Pt. Legal Size • Single Ply Tab	500	54 Lbs.
8686	14 Pt. Legal Size • Single Ply Tab	250	30 Lbs.
8689	11 Pt. Legal Size • Reinforced Tab	250	26 Lbs.
8690	14 Pt. Legal Size • Reinforced Tab	250	33 Lbs.

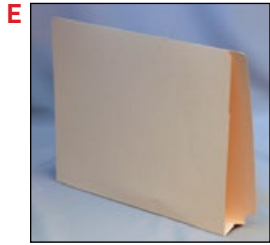

**E, F Manila Expansion Folders**

MODEL NO.	DESCRIPTION	CARTON QTY	CARTON WT.
<b>E</b> 8655	14 Pt. Letter Size • 1 <sup>7</sup> / <sub>8</sub> " Expansion • Shipped Flat	400	44 Lbs.
<b>F</b> 9155	14 Pt. Letter Size • Full End Tab • Reinforced Top & Side 1 <sup>3</sup> / <sub>4</sub> " Expansion • Shipped Flat	250	35 Lbs.

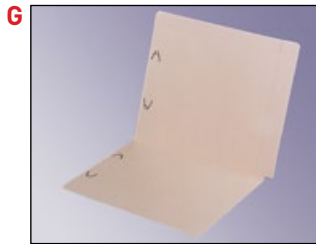

**G Letter Size • Manila • Reinforced • 12" W x 9<sup>1</sup>/<sub>2</sub>" H**

MODEL NO.	DESCRIPTION	CARTON QTY	CARTON WT.
8662	14 Pt. Letter Size • Reinforced Top & Side Dual Tab Folder • 9" Front • Works for Drawer or Shelf	150	31 Lbs.



**H Classifolder • Manila • Single Ply Tab • 12<sup>1</sup>/<sub>4</sub>" W x 9<sup>1</sup>/<sub>2</sub>" H**

MODEL NO.	DESCRIPTION	CARTON QTY	CARTON WT.
8654	8685 Folder • Blank 11 Pt. Manila Single Partition Glued in (4) 2" Duraclip Fasteners Installed	125	30 Lbs.



### A Color Stock Folders • Reinforced Tab • 12¼" W x 9½" H

**COLORS:** Light Blue, Brown, Pink, Purple, Tan, Green, Orange, Red, Yellow, White, Gray, and Dark Blue

MODEL NO.	DESCRIPTION	CARTON QTY	CARTON WT.
8661	11 Pt. Letter Size • End Tab	350	34 Lbs.



### B Color Banded Folders • Manila • Reinforced Tab • 12¼" W x 9½" H

**COLORS:** Black, Light Blue, Dark Blue, Brown, Gray, Light Green, Dark Green, Orange, White, Yellow, Pink, Purple, and Red

MODEL NO.	DESCRIPTION	CARTON QTY	CARTON WT.
8687C	11 Pt. Letter Size • Color Banded End Tab	350	34 Lbs.



### C Color Frame Folders • White Stock • Reinforced Tab • 12¼" W x 9½" H

**COLORS:** Orange, Yellow, Magenta, Gray, Teal, Purple, Blue, Lime, and Hot Pink

MODEL NO.	DESCRIPTION	CARTON QTY	CARTON WT.
8646C	14 Pt. Letter Size • End Tab • Color Banded Around Perimeter	250	32 Lbs.

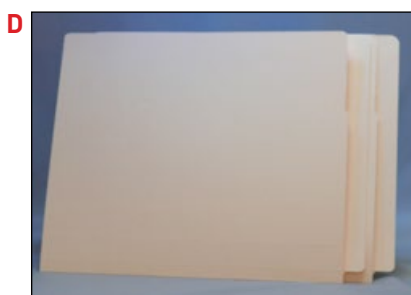

### D Ames Match • Manila • Reinforced Tab • 12⅛" W x 9½" H

MODEL NO.	DESCRIPTION	CARTON QTY	CARTON WT.
8791	11 Pt. Letter Size • Book Score • Top & Side Tab 2⅞" Side Reinforcement • ⅞" Top Reinforcement	350	34 Lbs.
8795	14 Pt. Letter Size • Book Score • Top & Side Tab 2⅞" Side Reinforcement • ⅞" Top Reinforcement	250	31 Lbs.



### E Barkley Match • Manila • Reinforced Tab • 12¼" W x 9½" H

MODEL NO.	DESCRIPTION	CARTON QTY	CARTON WT.
9287	Barkley 1190 Match 11 Pt. Letter Size • End Tab • Embedded Tick Marks	350	34 Lbs.
9288	Barkley 1490 Match 14 Pt. Letter Size • End Tab • Embedded Tick Marks	250	32 Lbs.



**F File Folder • Drawer • 11¾" W x 9½" H**

MODEL NO.	DESCRIPTION	CARTON QTY	CARTON WT.
8663-1	11 Pt. Letter Size • Full Cut Tab • 9" Front • 9" Tick-Marks	500	40 Lbs.
8665-1	14 Pt. Letter Size • Full Cut Tab • 9" Front • 9" Tick-Marks	500	44 Lbs.



**Manila Pocket Folder • One Piece**

MODEL NO.	DESCRIPTION	CARTON QTY	CARTON WT.
<b>G</b> 8600	11 Pt. Top Opening • 11¾" W x 9½" H	300	29 Lbs.
<b>G</b> 8601	11 Pt. Top Opening • 12¼" W x 9½" H	300	29 Lbs.
<b>G</b> 8606	11 Pt. Top Opening • 12½" W x 10½" H	300	32 Lbs.
<b>H</b> 8607	14 Pt. End & Top Opening • 12¼" W x 9½" H	500	62 Lbs.
<b>I</b> 8611	11 Pt. Top Opening • ¾" Expansion • 12¾" W x 9¾" H	250	26 Lbs.
<b>J</b> 8614	11 Pt. Built in Pocket with Flap • 12¼" W x 9½" H	250	33 Lbs.



## KARDEX COMPATIBLE FOLDERS COLOR SWATCHES

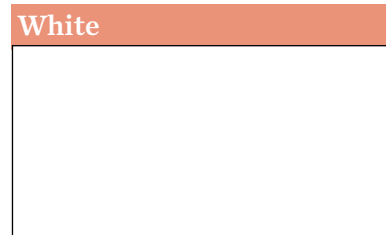
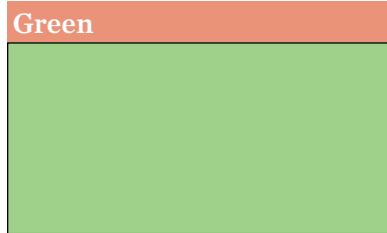
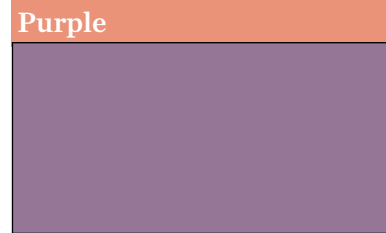



KARDEX COMPATIBLE FOLDERS

**Kardex • Color Stock • 11 Pt. Letter Size**

**COLORS:** Light Blue, Brown, Green, Tan, White, Orange, Purple, Red, Pink & Yellow

MODEL NO.	DESCRIPTION	CARTON QTY	CARTON WT.
<b>A</b> KA-5099R	Kardex Straight Edge Reinforced • 9" Front Flap • 11¼" W x 9½" H	500	45 Lbs.
<b>B</b> KA-50998R	Kardex Top Tab Reinforced • 9½" Front Flap • 11¼" W x 10" H • Tab 2/5 ROC	500	45 Lbs.
<b>C</b> KA-2078618	Kardex Colorsan® • 9" Front Flap • 11¼" W x 9½" H • A-Z scale for Drawer and Shelf filing	500	45 Lbs.
<b>D</b> KA-2610002	Kardex TCUCP® • Top & Side Tab • 9" Front Flap • 11¼" W x 9½" H • 0-9 Scale	500	45 Lbs.
<b>E</b> KA-2610003R	Kardex Colorsan® • Top & Side Tab • 9" Front Flap • A-Z scale left Back Flap only 11¼" W x 9½" H	500	45 Lbs.
<b>F</b> KA-2610004R	Kardex Right End Tab • Right Tab Printed with Tick Marks • 12¼" W x 9½" H	500	45 Lbs.
<b>G</b> KA-2610005R	Kardex Left End Tab • Left Tab Printed with Tick Marks • 12¼" W x 9½" H	500	45 Lbs.
<b>H</b> TDV-1B	Kardex No Label • 11¼" W x 9½" H	500	45 Lbs.

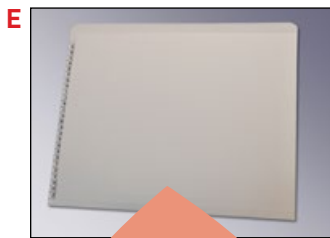
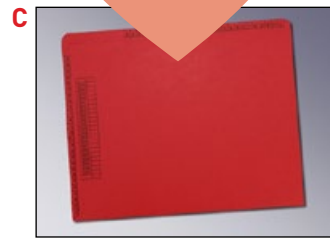

## KARDEX COMPATIBLE FOLDERS

### Kardex • Color Stock • 20 Pt. Letter Size • 9" Front

**COLORS:** Light Blue, Brown, Green, Tan, White, Orange, Purple, Red, Pink & Yellow

MODEL NO.	DESCRIPTION	CARTON QTY	CARTON WT.
<b>A</b> KA-2510003	Kardex Colorscan® • Printed Back Flap A-Z Scale • 11¼" W x 9½" H • 2" Expansion	250	39 Lbs.
<b>B</b> KA-2510004	Kardex • Right Tab with Printed Tick Marks • 12¼" W x 9½" H • 2" Expansion	250	39 Lbs.
<b>C</b> KA-2510005	Kardex • Left Tab with Printed Tick Marks • 12¼" W x 9½" H • 2" Expansion	250	39 Lbs.
<b>D</b> KA-2510004/3/2Scored	Kardex Scored Folded • Letter Size • 9" Front • 12¼" W x 9½" H	250	39 Lbs.

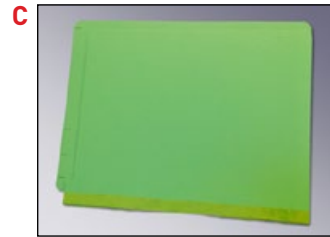

### Kardex • Color Stock • 20 Pt. Legal Size • 9" Front

**COLORS:** Light Blue, Brown, Green, Tan, White, Orange, Purple, Red, Pink & Yellow

MODEL NO.	DESCRIPTION	CARTON QTY	CARTON WT.
<b>E</b> KA-2520003	Kardex Colorscan® • 2" Expansion • A-Z Scale • 14⅞" W x 9½" H • 2" Expansion	250	50 Lbs.
<b>F</b> KA-2520004	Kardex End Tab • 2" Expansion • 15¼" W x 9½" H • Right Tab with printed Tick Marks • 1½" Expansion	250	50 Lbs.
<b>G</b> KA-2520005	Kardex End Tab • 2" Expansion • 11¼" W x 9½" H • Left Tab with Printed Tick Marks • 1½" Expansion	250	50 Lbs.
<b>H</b> KA-2520004/3/2S	Kardex End Tab • 15¼" W x 9½" H • Right Tab with printed Tick Marks • Scored and folded for ¾" Expansion	250	50 Lbs.

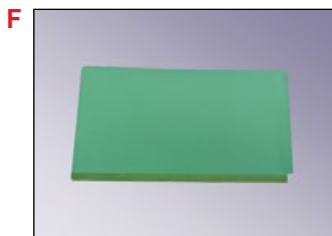

**KARDEX COMPATIBLE FOLDERS**

**Kardex • Color Stock • 11 Pt. Legal Size • 9" Front**

**COLORS:** Light Blue, Brown, Green, Tan, White, Orange, Purple, Red, Pink & Yellow

MODEL NO.	DESCRIPTION	CARTON QTY	CARTON WT.
<b>K</b> KA-5299R	Kardex Straight Edge Reinforced • 14 <sup>7</sup> / <sub>8</sub> " W x 9 <sup>1</sup> / <sub>2</sub> " H • 9" Front Flap	500	53 Lbs.
<b>L</b> KA-52998R	Kardex Top Tab Reinforced • 14 <sup>7</sup> / <sub>8</sub> " W x 9 <sup>1</sup> / <sub>2</sub> " H • 9 <sup>1</sup> / <sub>2</sub> " Front Flap • Tab 2/5 ROC	500	53 Lbs.
<b>M</b> KA-2620004R	Kardex End Tab • Scored and folded for 3/4" Expansion • 15 <sup>1</sup> / <sub>4</sub> " W x 9 <sup>1</sup> / <sub>2</sub> " H • Right Tab with printed Tick Marks	500	53 Lbs.
<b>N</b> KA-2620003R	Kardex Colorsan® • 9" Front Flap • 14 <sup>7</sup> / <sub>8</sub> " W x 9 <sup>1</sup> / <sub>2</sub> " H • Printed A-Z Left Back Flap Only	500	53 Lbs.
<b>O</b> KA-2620003R	Kardex TCUCP® • 9" Front Flap • 14 <sup>7</sup> / <sub>8</sub> " W x 9 <sup>1</sup> / <sub>2</sub> " H • Printed 0-9 Scale Back Flap	500	53 Lbs.

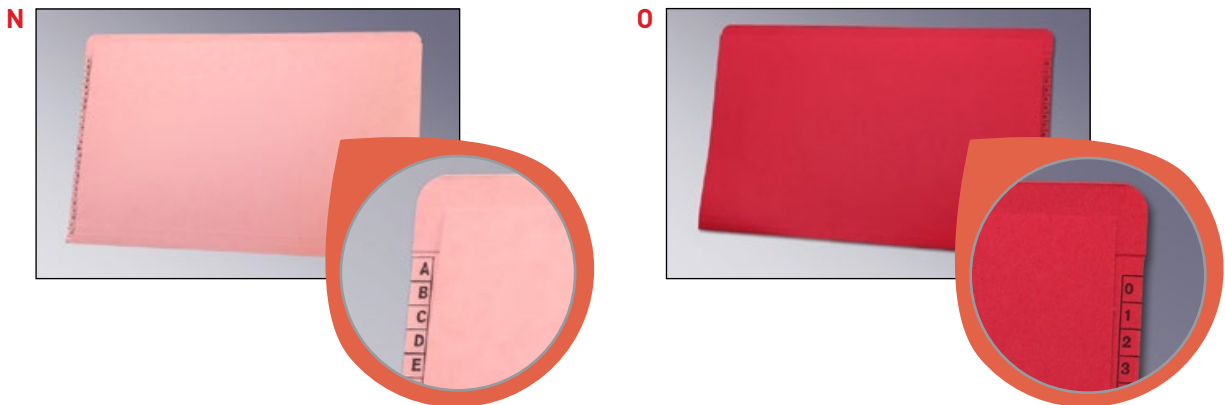

**Kardex • 11 Pt. Kraft Folder**

**COLOR:** Kraft

MODEL NO.	DESCRIPTION	CARTON QTY	CARTON WT.
<b>P</b> KA-50420R	Letter Straight Edge Reinforced • 11 <sup>3</sup> / <sub>4</sub> " W x 9 <sup>1</sup> / <sub>2</sub> " H • 9" Front Flap	500	45 Lbs.
<b>Q</b> KA-50428R	Letter Top Tab Reinforced • 11 <sup>3</sup> / <sub>4</sub> " W x 10" H • 9 <sup>1</sup> / <sub>2</sub> " Front Flap • 2/5 ROC	500	45 Lbs.
<b>R</b> KA-524281R	Legal Top Tab Reinforced • 14 <sup>7</sup> / <sub>8</sub> " W x 10" H • 9 <sup>1</sup> / <sub>2</sub> " Front Flap • 2/5 ROC	500	45 Lbs.



## Kardex • Manila • Reinforced Tab • 11 Pt.

MODEL NO.	DESCRIPTION	CARTON QTY	CARTON WT.
<b>S</b> KA-5050R	Letter Size • Straight Edge Reinforced • 11¾" W x 9½" H • 9" Front Flap	500	45 Lbs.
<b>T</b> KA-5058R	Letter Size • Top Tab Reinforced • 11¾" W x 10" H • 9½" Front Flap • Tab 2/5 ROC	500	45 Lbs.
<b>U</b> KA-5250R	Legal Size • Straight Edge Reinforced • 147/8" W x 9½" H • 9" Front Flap	500	45 Lbs.
<b>V</b> KA-2610004RM	Letter Size • End Tab Reinforced • 12¼" W x 9½" H • 9" Front Flap	500	45 Lbs.
<b>W</b> KA-2620004RM	Legal Size • End Tab Reinforced • 15¼" W x 9½" H • 9" Front Flap	500	45 Lbs.

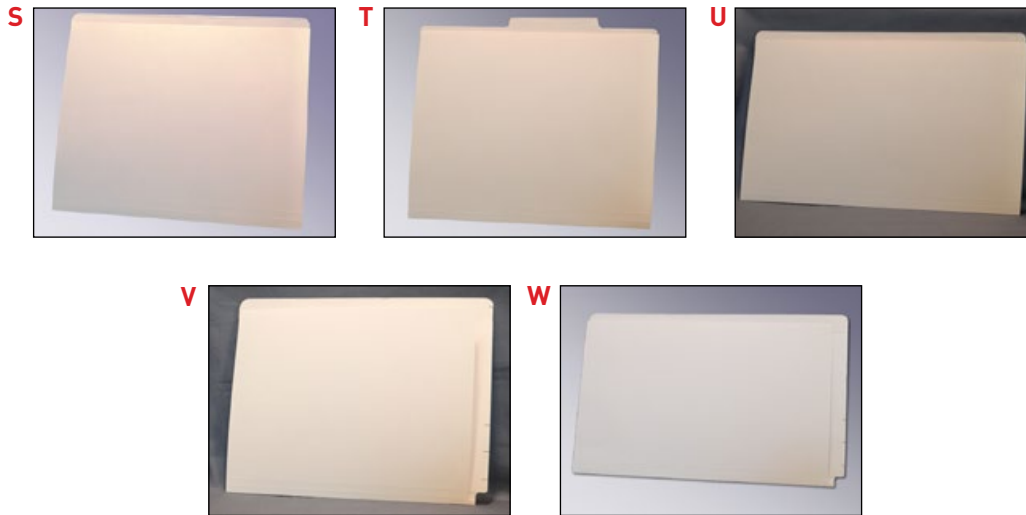

## Jeter Compatible • Manila • End Tab • 12¼" W x 9½" H • 3- 5/16" Expansion Scores Black Guidelines

MODEL NO.	DESCRIPTION	CARTON QTY	CARTON WT.
<b>A</b> J2241	14 Pt. Letter Size • Reinforced Letter Folder • Jeter Match Super Coder J2241	400	45 Lbs.
<b>B</b> J2272	14 Pt. Letter Size • 11 Pt. Single Pocket • 9⅞" W x 6⅞" H • Jeter Match Super Code J2272	250	43 Lbs.
<b>C</b> J2273	14 Pt. Letter Size • Reinforced Letter Folder • 9 Pt. Double Pocket • 8¾" W x 8½" H Rear Pocket 8¾" W x 8½" H Front Pocket • Jeter Match Super Coder J2273	125	23 Lbs.
<b>D</b> J14900	14 Pt. Pocket File • 11¾" W x 9½" H • Jeter Match J14900	400	42 Lbs.
<b>E</b> J14901	14 Pt. Pocket File • 12¼" W x 9½" H • Jeter Match J14901	400	45 Lbs.
J2131	11 Pt. Letter Size • Single Ply Folder • Jeter Match Super Coder J2131	500	42 Lbs.
J2231	14 Pt. Letter Size • Single Ply Folder • Jeter Match Super Coder J2231	500	52 Lbs.

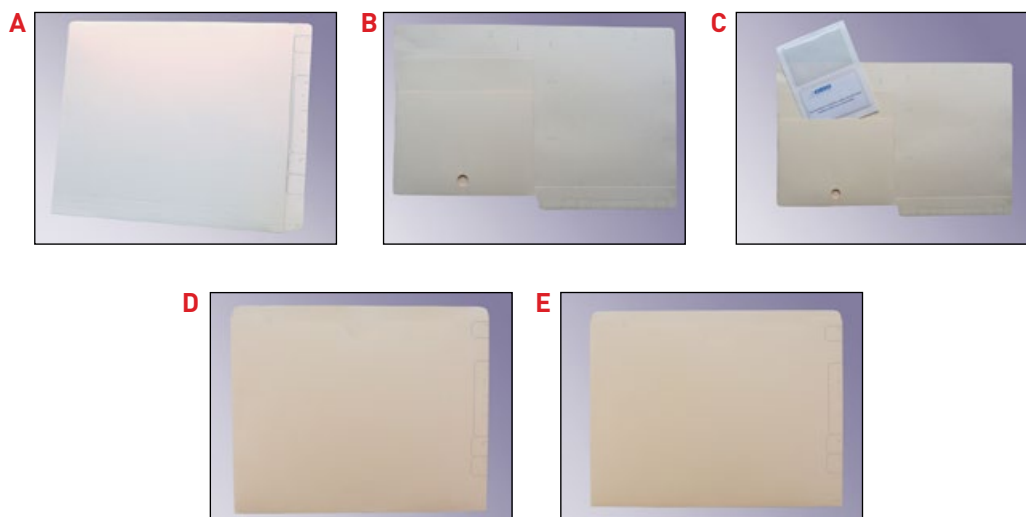

EXPANSION POCKETS

22 pt. Expansion Pockets

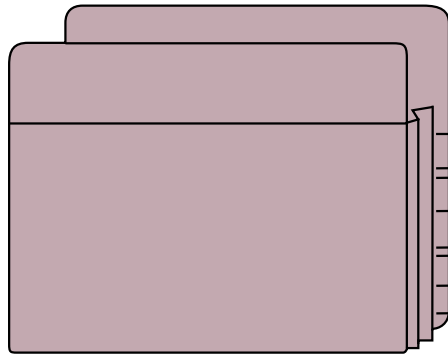

Letter

MODEL NO.	DESCRIPTION	QUANTITY
F5600	1 3/4" Expansion Lavender	box of 50
F5650	3 1/2" Expansion Lavender	box of 50
F5610	5 1/4" Expansion Lavender	box of 50

Legal

MODEL NO.	DESCRIPTION	QUANTITY
F5700	1 3/4" Expansion Lavender	box of 50
F5750	3 1/2" Expansion Lavender	box of 50
F5755	3 1/2" Expansion Red Rope	box of 50

Red Rope Expansion Pockets • 42 pt. Back, 28 pt. Front

Letter

MODEL NO.	DESCRIPTION	QUANTITY
F1832	1 3/4" Expansion	box of 50
F1834	3 1/2" Expansion	box of 50

Legal

MODEL NO.	DESCRIPTION	QUANTITY
F1842	1 3/4" Expansion	box of 50
F1844	3 1/2" Expansion	box of 50

Long Letter

MODEL NO.	DESCRIPTION	QUANTITY
F1852	1 3/4" Expansion, Long Letter 13" W	box of 50
F1854	3 1/2" Expansion, Long Letter 13" W	box of 50

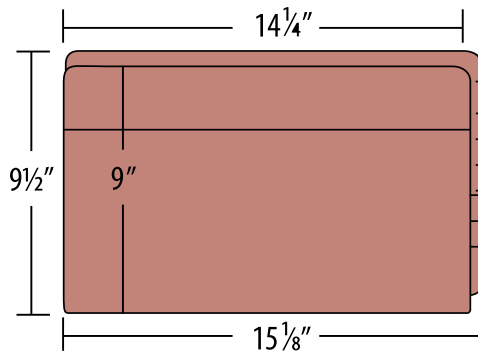
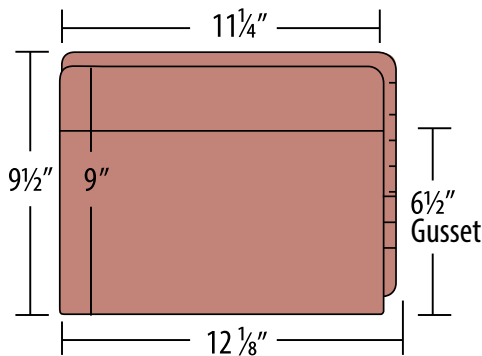

Top Tab Expansion Pockets • 22 pt. Red Rope, Gusset height 6 1/2"

Letter

(9" high front; 9 1/2" high back x 11 3/4" wide)

MODEL NO.	DESCRIPTION	QUANTITY
1130-00	1 3/4" Expansion	box of 50
1131-00	3 1/2" Expansion	box of 50

Legal

(9" high front; 9 1/2" high back x 14 3/4" wide)

MODEL NO.	DESCRIPTION	PRICE
1132-00	1 3/4" Expansion	box of 50
1133-00	3 1/2" Expansion	box of 50



## Manila Expansion Pockets

Jeter expansion pockets have many premium attributes, including:

1. Superior Quality
2. Maximum Gusset Strength
3. Extra Deep Glued Edge Adds Durability
4. Extra Strong Corners With Optional Rivets
5. Longer Pocket Tabs for Better Label Fit
6. Extra Heavy Covers, Front & Back

### Letter Expansion Pockets Letter Size — 12-3/8" W x 9-1/2" H

MODEL NO.	EXPANSION	DOUBLE PLY	PAPER POINT	QTY./CARTON	WT./CARTON
J13514	1-3/4"	•	14	50	11
J13524	3-1/2"	•	14	50	11
J13534	5-1/4"	•	14	50	16

### Legal Expansion Pockets Legal Size — 15-3/8" W x 9-1/2" H

MODEL NO.	EXPANSION	DOUBLE PLY	PAPER POINT	QTY./CARTON	WT./CARTON
J13516	1-3/4"	•	14	50	14
J13526	3-1/2"	•	14	50	14
J13536	5-1/4"	•	14	50	20

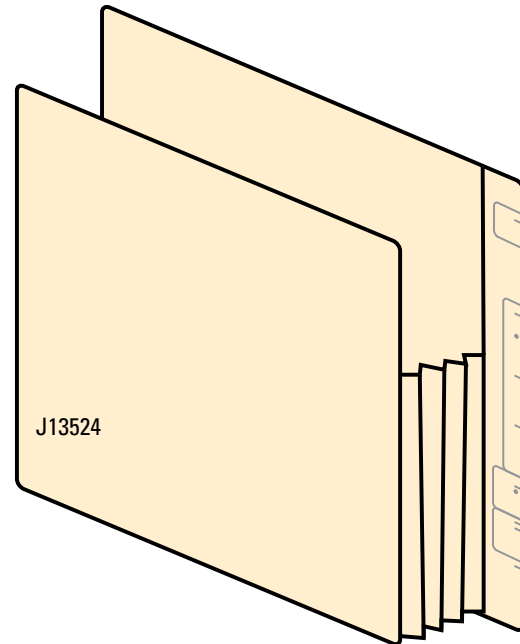

TAB MATCH COLOR & COLOR STRIPE FOLDERS

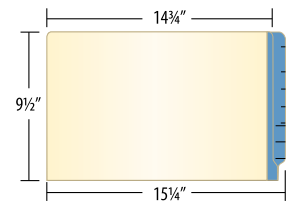
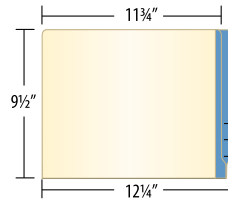

Manila Color Stripe Folders

Letter

MODEL NO.	DESCRIPTION	BOX/QTY
1162-**-	11 pt. Standard	box of 100

Legal

MODEL NO.	DESCRIPTION	BOX/QTY
1163-**-	11 pt. Standard	box of 100

\*\*Choose appropriate color suffix.

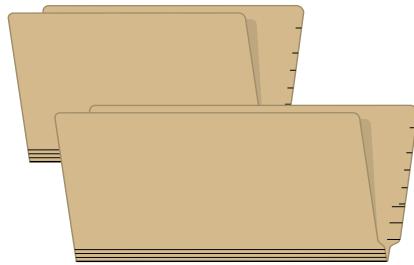

Kraft Side Tab Folders

Letter

MODEL NO.	DESCRIPTION	BOX/QTY
1129-00	17 pt. Single Ply	box of 50

Legal

MODEL NO.	DESCRIPTION	BOX/QTY
1119-00	17 pt. Single Ply	box of 50

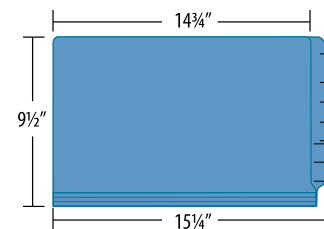
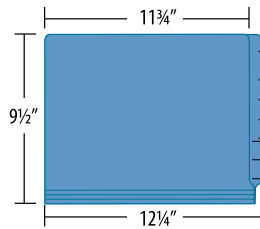

Standard Solid Color Side Tab Folders

Letter

MODEL NO.	DESCRIPTION	BOX/QTY
1106-**-	11 pt. Reinforced Tab	box of 100
1406-**-	14 pt. Reinforced Tab	box of 50

Legal

MODEL NO.	DESCRIPTION	BOX/QTY
1126-**-	11 pt. Reinforced Tab	box of 100
1426-**-	14 pt. Reinforced Tab	box of 50

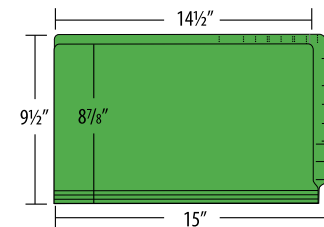
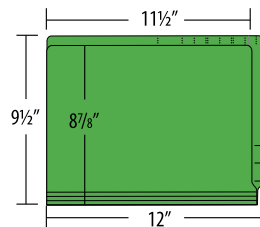

**Add color to your world!**  
Separate yourself from the crowd by using color to identify your files.

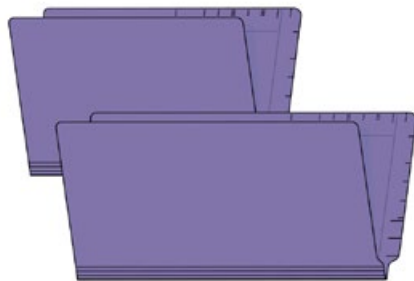

2TAB Solid Color Folders

Letter

MODEL NO.	DESCRIPTION	BOX/QTY
1334-**-	11 pt. 2TAB	box of 100
1335-**-	14 pt. 2TAB	box of 50

Legal

MODEL NO.	DESCRIPTION	BOX/QTY
1336-**-	11 pt. 2TAB	box of 50
1337-**-	14 pt. 2TAB	box of 50

\*\*Choose appropriate color suffix.

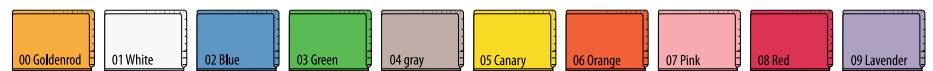

11 pt. is double-ply (reinforced) top and side tabs. 14 pt. is single-ply top tab and double-ply side tab.

## TAB MATCH POCKETS

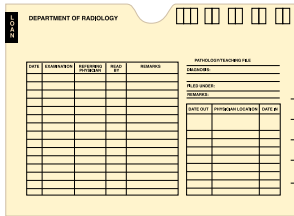

1177-00

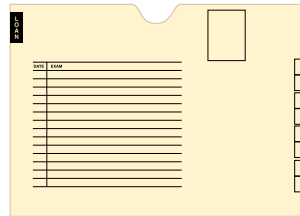

1177-25

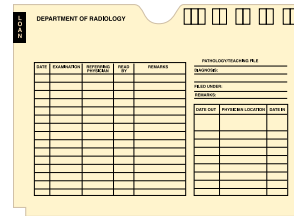

1177-75

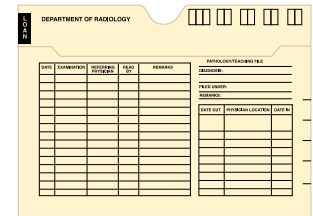

1177-50

### One Piece Manila X-Ray Jackets

14<sup>1</sup>/<sub>2</sub>" x 18<sup>1</sup>/<sub>4</sub>"

MODEL NO.	DESCRIPTION	CARTON QTY
1177-00	11 pt. flat	100
1177-25	11 pt. flat	100

### Ames Compatible One Piece Manila X-Ray Jackets

14<sup>1</sup>/<sub>2</sub>" x 18<sup>1</sup>/<sub>4</sub>" x 3<sup>3</sup>/<sub>4</sub>"

MODEL NO.	DESCRIPTION	CARTON QTY
1177-75	11 pt. 3/4" expandable	100
1177-50	11 pt. dual pocket	100

## Keep Documents Safe

With closed sides these pockets keep small items in file with larger documents. Available with two sides closed, three sides closed, manila or color side tab.

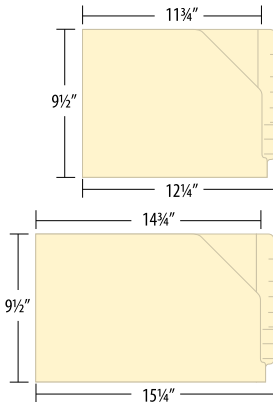

### Manila Pockets – Closed 2 Sides

#### Letter

MODEL NO.	DESCRIPTION	BOX/QTY
1178-00	1 pt Manila Flat Pocket	box of 100
1175-00	11 pt Manila Pocket 1 1/2" expansion	box of 50

#### Legal

MODEL NO.	DESCRIPTION	BOX/QTY
1179-00	11 pt Manila Flat Pocket	box of 50
1176-00	11 pt Manila Pocket 1 1/2" expansion	box of 50

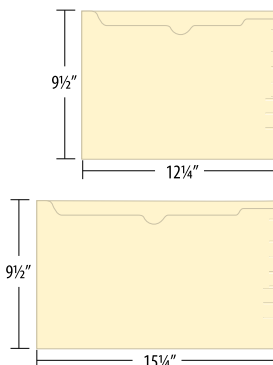
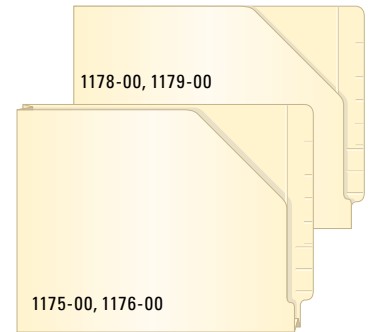

### Manila Pockets – Closed 3 Sides

#### Letter

MODEL NO.	DESCRIPTION	BOX/QTY
1168-00	11 pt Manila Flat Pocket	box of 100
1180-00	11 pt Manila Pocket 3/4" expansion	box of 100

#### Legal

MODEL NO.	DESCRIPTION	BOX/QTY
1169-00	11 pt Manila Flat Pocket	box of 100
1181-00	11 pt Manila Pocket 3/4" expansion	box of 50

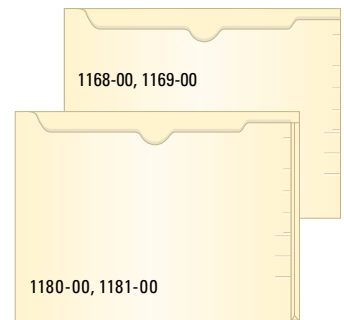



**Manila Color Stripe Flat Pockets – Closed 2 Sides**

**Letter**

MODEL NO.	DESCRIPTION	BOX/QTY
1172-**	11 pt Color Stripe Flat Pocket	box of 100

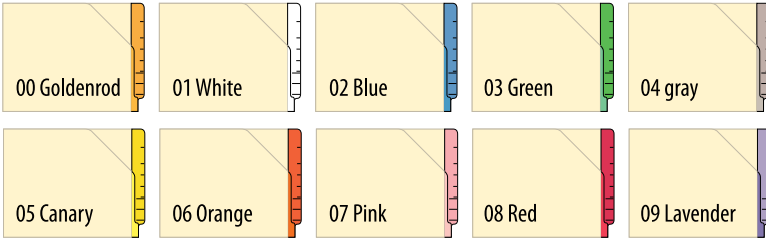

\*\*Choose appropriate color suffix:

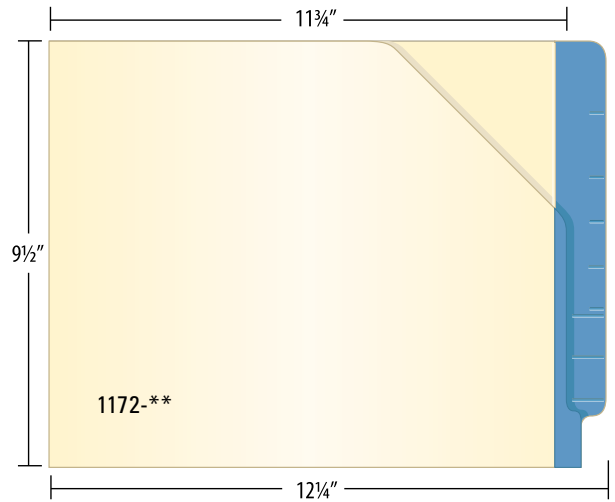

**Color One Piece Pockets**

**Letter**

MODEL NO.	DESCRIPTION	BOX/QTY
1174-**	11 pt Color One Piece Flat Pocket closed two sides, Reinforced Tab	box of 100
1184-**	11 pt Color One Piece Pocket w/ 4" Lower End Tab, Reinforced Tab	box of 100
1166-**	11 pt Color Flat Pocket closed 3 sides	box of 100

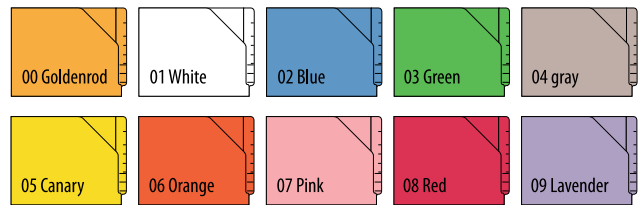

\*\*Choose appropriate color suffix.

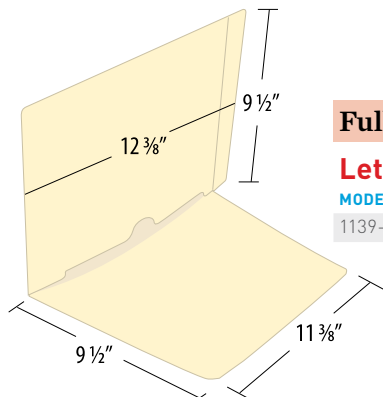
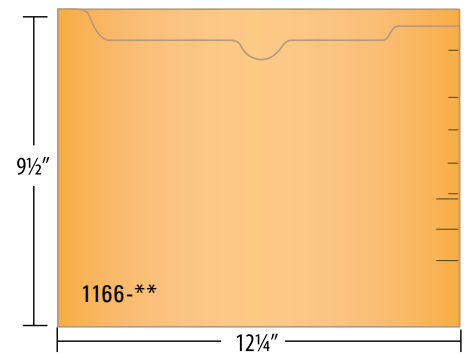
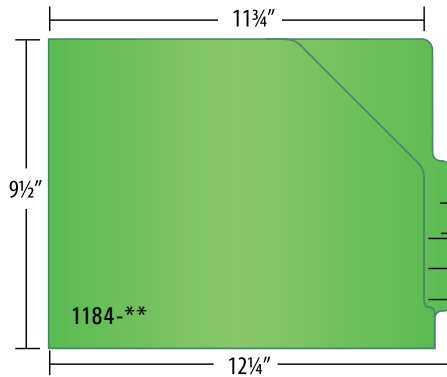
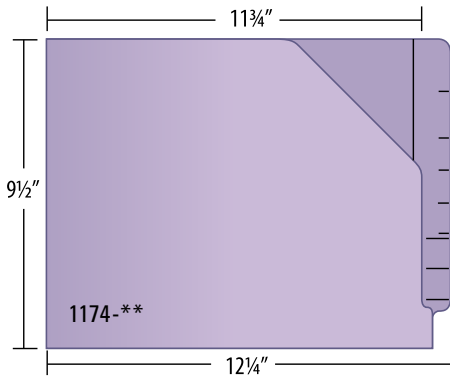

**Full Pocket File Folder**

**Letter**

MODEL NO.	DESCRIPTION	BOX/QTY
1139-00	11 pt Manila letter size, full single ply side tab, closed 3 sides	box of 50



## TAB MATCH EXPANSION POCKETS

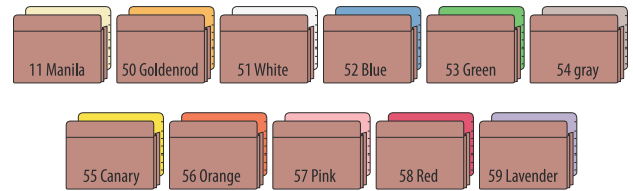
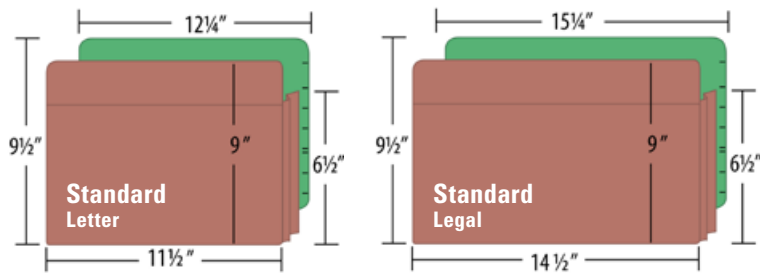

\*\*Choose appropriate color suffix.

### 22 pt. Red Rope Expansion Pockets with Color Backs Red rope front and gusset, color back, gusset height 6 1/2"

#### Letter

MODEL NO.	DESCRIPTION	BOX/QTY
1187-**	1 3/4" Standard Color Back Expansion Pockets	box of 50
1189-**	3 1/2" Standard Color Back Expansion Pockets	box of 50
4387-**	5 1/4" Standard Color Back Expansion Pocket	box of 50

#### Legal

MODEL NO.	DESCRIPTION	BOX/QTY
1191-**	1 3/4" Standard Color Back Expansion Pocket	box of 50
1193-**	3 1/2" Standard Color Back Expansion Pockets	box of 50
4397-**	5 1/4" Standard Color Back Expansion Pocket	box of 50

### 22 pt. Standard Solid Color Expansion Pockets

#### Letter

MODEL NO.	DESCRIPTION	BOX/QTY
1379-**	3 1/2" Standard Solid Color Expansion Pockets	box of 50

#### Legal

MODEL NO.	DESCRIPTION	BOX/QTY
1381-**	3 1/2" Standard Solid Color Expansion Pockets	box of 50

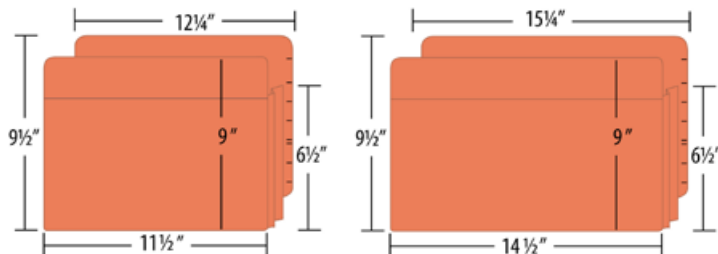

1381-\*\*

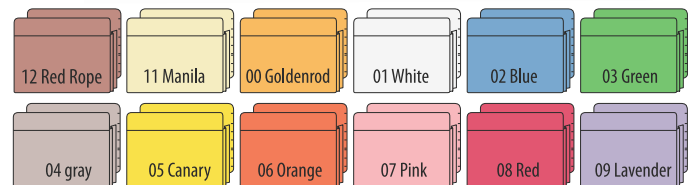

\*\*Choose appropriate color suffix.

## Low Gusset Expansion Pockets

### 22 pt. Red Rope Front and Bright Goldenrod Back

Red rope front and gusset, goldenrod back, left gusset height 9", right gusset height 1 1/2"

#### Letter

MODEL NO.	DESCRIPTION	BOX/QTY
1187-00	1 3/4" Expansion (9 1/2" h, 11 3/4" w x 12 1/4" w overall)	box of 50
1189-00	3 1/2" Expansion (9 1/2" h, 11 3/4" w x 12 1/4" w overall)	box of 50

#### Legal

MODEL NO.	DESCRIPTION	BOX/QTY
1191-00	1 3/4" Expansion (9 1/2" h, 14 3/4" w x 15 1/4" w overall)	box of 50
1193-00	3 1/2" Expansion (9 1/2" h, 14 3/4" w x 15 1/4" w overall)	box of 50

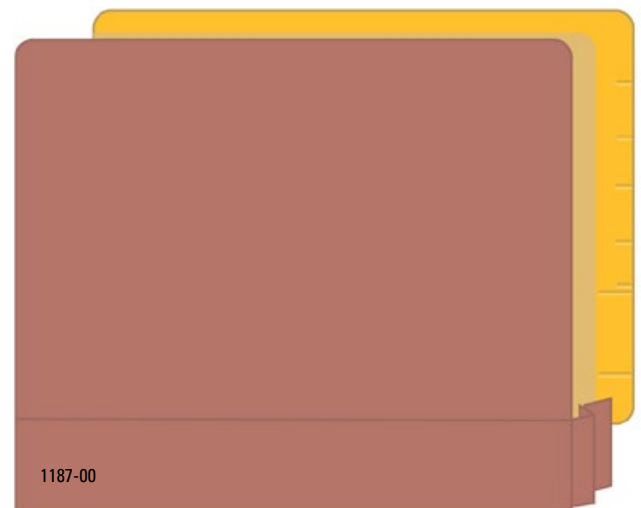

TAB MATCH TOP TAB FOLDERS

Manila Folders

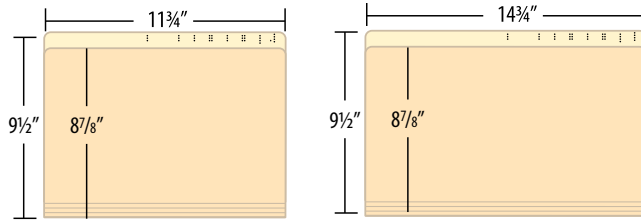

Letter

MODEL NO.	DESCRIPTION	BOX/QTY
1112-00	11 pt Double Ply	box of 100
1111-00	14 pt Single Ply	box of 100

Legal

MODEL NO.	DESCRIPTION	BOX/QTY
1122-00	11 pt Double Ply	box of 50
1114-00	14 pt Single Ply	box of 50

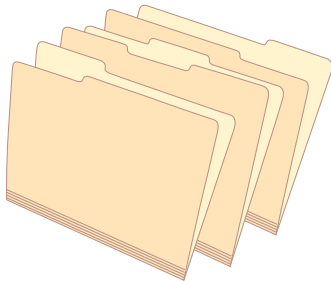

Letter (8 7/8" high front; 9 1/2" high back x 11 3/4" wide)

MODEL NO.	DESCRIPTION	BOX/QTY
1157-00	11 pt Single Ply Positions 123 collated	box of 100
1157-L	11 pt Single Ply Left Tab	box of 100
1157-R	11 pt Single Ply Right Tab	box of 100
1157-C	11 pt Single Ply Center Tab	box of 100

Legal (8 7/8" high front; 9 1/2" high back x 14 3/4" wide)

MODEL NO.	DESCRIPTION	BOX/QTY
1158-00	11 pt Single Ply Positions 123 collated	box of 100
1158-L	11 pt Single Ply Left Tab	box of 100
1158-R	11 pt Single Ply Right Tab	box of 100
1158-C	11 pt Single Ply Center Tab	box of 100

Top Tab Solid Color Folders

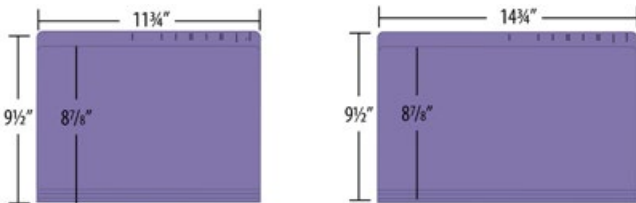

Letter

MODEL NO.	DESCRIPTION	BOX/QTY
1212-**	11 pt Double Ply Solid Color	box of 100
1222-**	14 pt Single Ply Solid Color	box of 100

Legal

MODEL NO.	DESCRIPTION	BOX/QTY
1211-**	11 pt Double Ply Solid Color	box of 50
1214-**	14 pt Single Ply Solid Color	box of 50

Replace \*\* with a color number

Green/Grey and Color Folders w/Dividers

All folders with 1 & 2 dividers have 2" expansion. Fasteners included on classification folders, in positions 1 & 3, and on dividers.

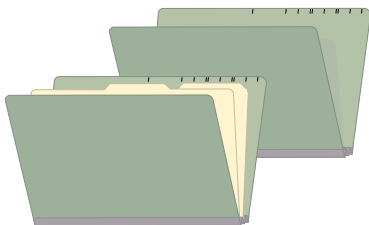

Type II Top Tab Pressboard and Classification Folders

Letter (8 7/8" high front; 9 1/2" high back x 11 3/8" wide)

MODEL NO.	DESCRIPTION	BOX/QTY
1255-00	25 pt Green/Grey 2" Expansion	box of 25
1255-**	25 pt Color 2" Expansion	box of 25

Legal (8 7/8" high front; 9 1/2" high back x 14 3/8" wide)

MODEL NO.	DESCRIPTION	BOX/QTY
1254-00B	25 pt Green/Grey 1 Divider	box of 25
1254-**B	25 pt Color 1 Divider	box of 25
1454-00B	25 pt Green/Grey 2 Dividers	box of 25
1454-**B	25 pt Color 2 Dividers	box of 25

Letter (8 7/8" high front; 9 1/2" high back x 14 3/8" wide)

MODEL NO.	DESCRIPTION	BOX/QTY
1257-00	25 pt Green/Grey 2" Expansion	box of 25
1257-**	25 pt Color 2" Expansion	box of 25

Legal (8 7/8" high front; 9 1/2" high back x 14 3/8" wide)

MODEL NO.	DESCRIPTION	BOX/QTY
1256-00B	25 pt Green/Grey 1 Divider	box of 25
1256-**B	25 pt Color 1 Divider	box of 25
1456-00B	25 pt Green/Grey 2 Dividers	box of 25
1456-**B	25 pt Color 2 Dividers	box of 25

Replace \*\* with a color number

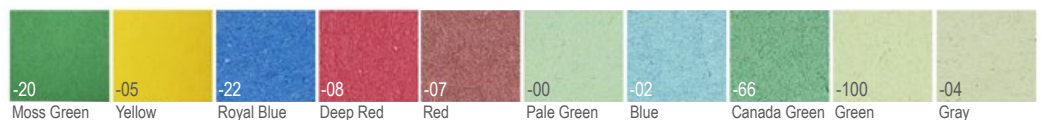

All pressboard folders may require up to a 35-day lead time.

## Accessories to meet your everyday needs.

GBS offers a complete line of pockets and fasteners in various sizes. This selection will allow you to further customize your filing system, providing you with products you can add to your files.

### A Manila Pockets

MODEL NO.	DESCRIPTION	CARTON QTY	CARTON WT.
8617	11 Pt. Book Scored • Pocket Back • Die Cut Slits to Hang on Fastener Overall Size 11 <sup>3</sup> / <sub>8</sub> " W x 10 <sup>1</sup> / <sub>2</sub> " H • 8 <sup>1</sup> / <sub>2</sub> " W x 9 <sup>1</sup> / <sub>4</sub> " H Pocket	300	27 Lbs.



### B Polypropylene Pockets • Pressure Sensitive

MODEL NO.	DESCRIPTION	CARTON QTY	CARTON WT.
8697	Outside: 7 <sup>1</sup> / <sub>8</sub> " W x 4 <sup>3</sup> / <sub>4</sub> " H • Opening on 7 <sup>1</sup> / <sub>8</sub> " Side Inside: 6 <sup>7</sup> / <sub>16</sub> " W x 4 <sup>1</sup> / <sub>4</sub> " H	100	15 Lbs.
2250	9 <sup>1</sup> / <sub>4</sub> " W x 6" H	100	3 Lbs.

# Clips

## C Extension Clip

MODEL NO.	DESCRIPTION	CARTON QTY	CARTON WT.
8885	Extension Clip • Set Includes: Base, Extension Piece, & Compressor Bar • Can be factory installed	400	7 Lbs.
8885-BASE	Extension Clip Base Only	100	1 Lbs.
8885-COMP-BAR	Extension Clip Compressor Bar Only	100	1 Lbs.
8885-EXT-PCS	Extension Clip Extension Pieces Only	100	1 Lbs.

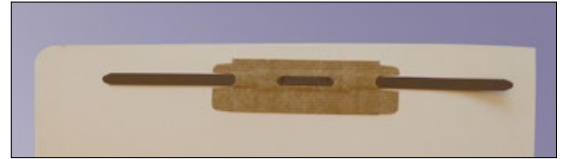

Bonded fasteners can be factory applied to any standard folder.

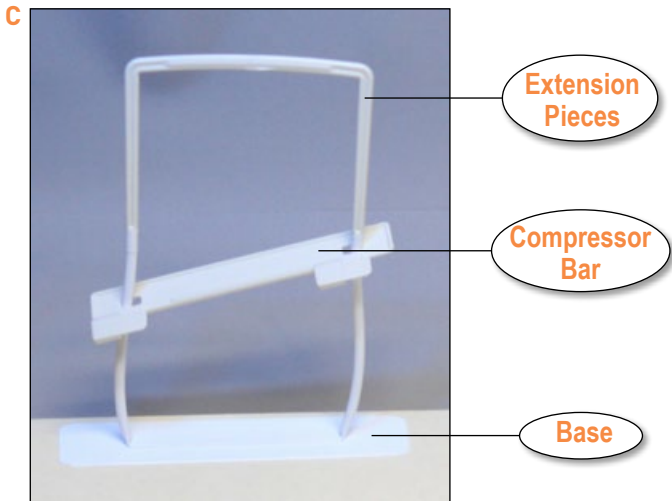

### Standard Fastener Positions

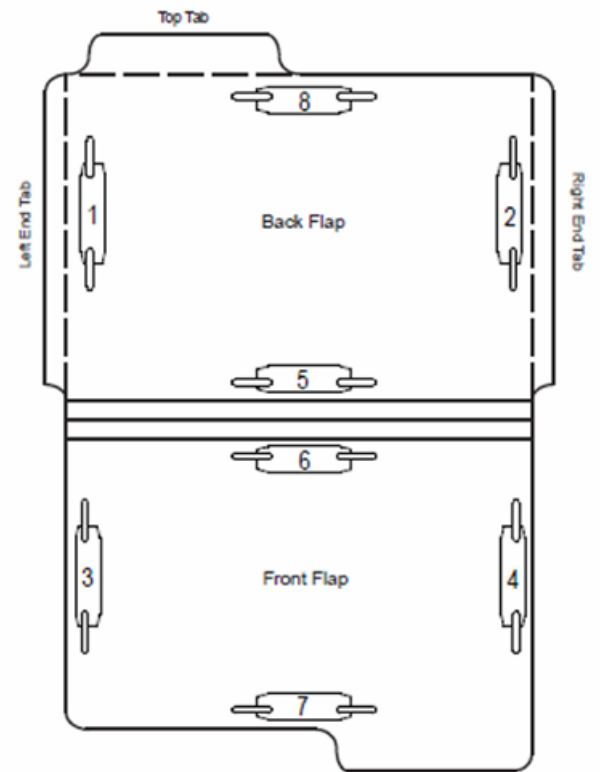

## Converting Drawer File Folders Into Lateral File Folders

Convert to lateral filing while protecting your investment in drawer file folders - just add conversion tabs. They have printed tick marks on the back to guide placement of color control labels. The conversion tabs are slit for placement on a fastener.

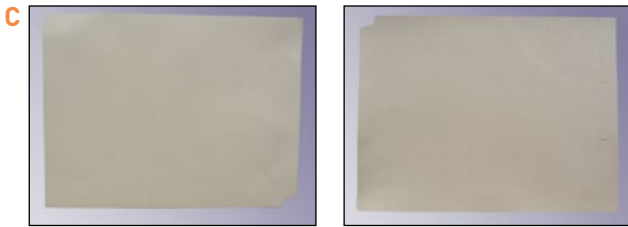

### C Conversion Tabs with Fastener Slots

MODEL NO.	DESCRIPTION	CARTON QTY	CARTON WT.
8631	11 Pt. Letter Conversion Tabs • Fastener Slots	1000	42 Lbs.
8635	14 Pt. Letter Conversion Tabs • Fastener Slots	750	42 Lbs.

### D The Converter with Self Adhesive Strips

MODEL NO.	DESCRIPTION	CARTON QTY	CARTON WT.
8669	11 Pt. Letter Conversion Tabs • 7 <sup>3</sup> / <sub>8</sub> " H x 9" W (2) • Self-Adhesive Strips	100	3 Lbs.



## Factory Installed Computer Generated Strip Labels

Whether you require file folders pre numbered in sequence, or you are sending data files, GBS can print and apply full strip, Mylar laminated labels to the folder of your choice. We provide the label design, label proofing and label application. When you have a lot of folders to color code, this service will save countless hours. Your new folders will arrive in the desired sequence. Save time and money with our Factory Installed Computer Generated Strip Label Service.



## Simplify File Labeling

NetLabels allows you to color code and index your folders the way you want. NetLabels eliminates the need to bulk order pre-labeled folders or stockpile individual labels on rolls or sheets. When it is time to make-up a new folder, you simply access the NetLabels software, enter the file information, and print the label you need. What a relief! The process is quick, easy and efficient. NetLabels saves time and money by streamlining the file labeling process.

## Match Your Existing System

NetLabels can match the colors of your existing color-coded system and the arrangement of the labels on your folders. Simply enter the file name information and print out a single adhesive label on your desktop color printer. The adhesive strip label is easy to apply to your folder. You can print labels by typing information for each label one at a time; or by using a spreadsheet or data file saved on your computer system to print one or multiple labels accurately and with ease. NetLabels will match your existing filing system colors and alignment.



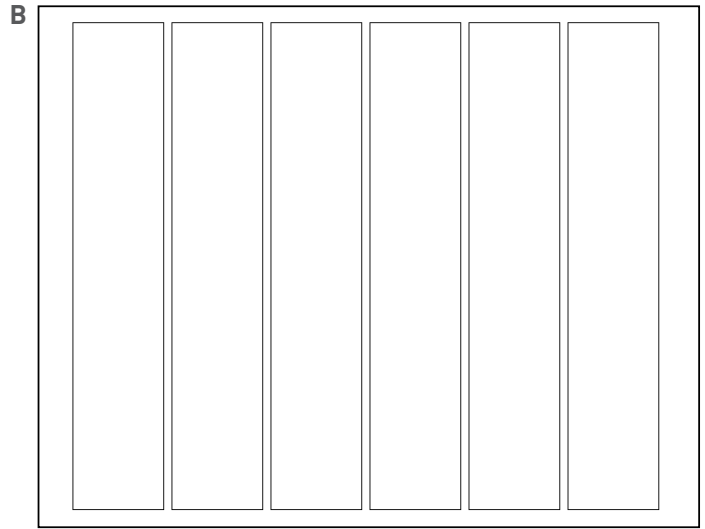
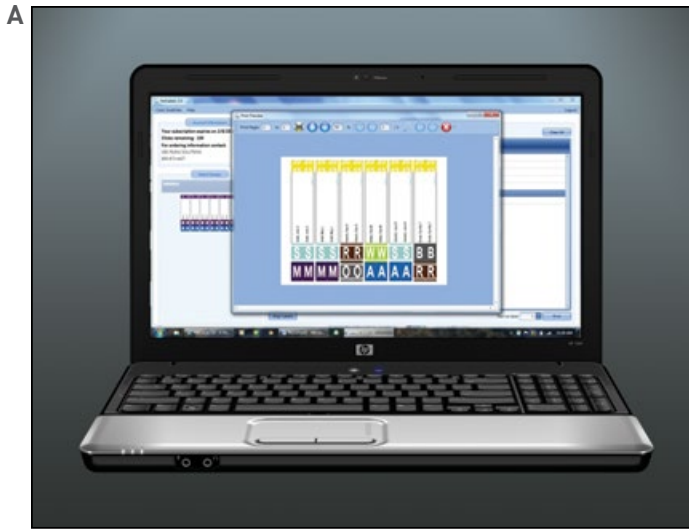

## A Internet Based System

MODEL NO.	DESCRIPTION
8929N	NetLabels Account Set-Up: Includes account set-up and password, 1 label design, printer mapping, 1 year of maintenance, unlimited label design changes, unlimited printer mappings, and unlimited phone/e-mail support. Available to unlimited users.
8989-1	Internet 1 year support & maintenance subscription
8989-2	Internet 2 year support & maintenance subscription
8989-3	Internet 3 year support & maintenance subscription
8929	NetLabels additional label design for existing user

## B The Converter with Self Adhesive Strips

MODEL NO.	DESCRIPTION	CARTON QTY	CARTON WT.
8960CL	8" x 1½" Adhesive Label • 6-Up	600	3 Lbs.
8961CL	8" x 1¼" Adhesive Label • 7 -Up	700	3 Lbs.
8962CL	8" x 1½" Laser Adhesive Label • 6-Up	600	3 Lbs.
8964CL	8" x 2⅞" Inkjet Conversion Label • Self-Adhesive • 4-Up • Grey Opaque Back	400	3 Lbs.
8965CL	9½" x 4⅛" Inkjet Kwik Strip • 1-Up Premium Waterfast Stock	500	3 Lbs.
8967CL	8" x 1½" Economy Laser/Inkjet Self Adhesive Label • 6-Up	600	3 Lbs.
8968CL	4" x 4" Inkjet Labels • Premium Waterfast Stock • 4, 8" x 1½" and 4, 3⅞" x 1½" Per Sheet	800	3 Lbs.

## C Year Band Labels

MODEL NO.	DESCRIPTION	CARTON QTY	CARTON WT.
8982	Inkjet Stock • 60 Labels Per Sheet	600	3 Lbs.

## D Label Lams

MODEL NO.	DESCRIPTION	CARTON QTY	CARTON WT.
8941	8" x 2" Label Lam Self-Adhesive Label Protector	100	1 Lb.





## Color Coded Strip Labels

We offer pre-printed factory applied labels to match most competitive systems. Color coded folders can be packaged in any required method. We can also supply pre-applied strip labels based on data that you supply.

To discuss pre-applied strip labels or other folder customization please call #888-822-9777 or email [csquotes@tab.com](mailto:csquotes@tab.com).





## Radiology

Radiology Jackets are available in various sizes with and without printing. In addition, we also stock jackets with and without report pockets. All radiology products can be custom printed and color-coded.

To discuss custom printed Radiology Jackets please call #888-822-9777 or email [csquotes@tab.com](mailto:csquotes@tab.com).

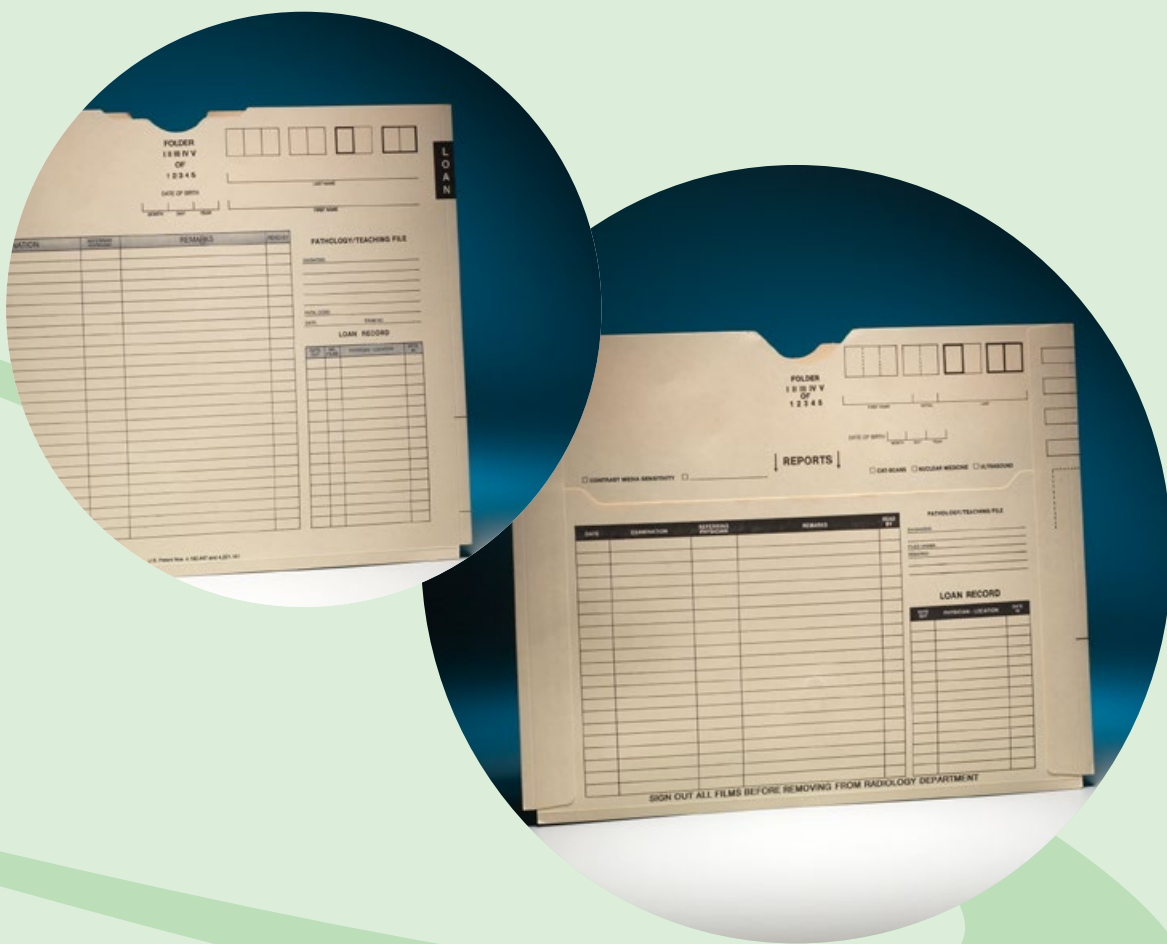



### A Blank Jacket • Manila • No Pocket

MODEL NO.	DESCRIPTION	CARTON QTY	CARTON WT.
8703	11 Pt. • 18¼" W x 14½" H	250	50 Lbs.
8705	11 Pt. • 18¼" W x 14½" H	250	50 Lbs.



### B Blank Jacket • Manila • With Report Pocket

MODEL NO.	DESCRIPTION	CARTON QTY	CARTON WT.
8741	11 Pt. • Manila • 18¼" W x 14½" H	200	50 Lbs.

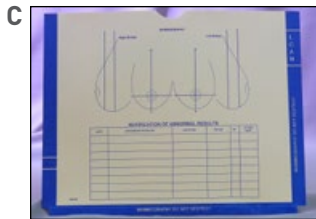

### C Stock Mammography Jacket

MODEL NO.	DESCRIPTION	CARTON QTY	CARTON WT.
8767	Mammography Jacket with Pocket. • Printed Two Sides	200	34 Lbs.

## Manila Jackets

MODEL NO.	REFERENCE NO.	DESCRIPTION	CARTON QTY	CARTON WT.
XJ1100	-	11 Pt. Manila Non-pocket Jacket • Printed - Ames Compatible Color Coding • 18¼" X 14½"	100	25 Lbs.
XJ1120	-	11 Pt. Manila Non-pocket Jacket • Printed - Ames Compatible • CC 18¼" X 14½"	100	25 Lbs.
XJ2100	-	11 Pt. Manila Pocket Jacket • 18¼" X 14½" • Ames Compatible Color Coding	100	25 Lbs.
XJ6470	6550	11 Pt. Manila Non-pocket Jacket • Printed - Ames Compatible Color Coding • 12¾" X 9¾"	200	50 Lbs.



## Pressboard Folders

Pressboard folders are manufactured to your order based on the physical requirements of the user. We offer a variety of colors and material types to suit individual needs.

Expansions are available in 1", 2", or 3" as standard, with larger expansion capabilities being available on a custom basis. Pressboard folders can include built-in dividers to segment the folder. We can also add fasteners and custom printing.

To customize your pressboard folders please call #888-822-9777 or email [csquotes@tab.com](mailto:csquotes@tab.com).



## TAB MATCH PRESSBOARD CLASSIFICATION FOLDERS

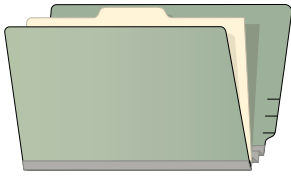

### 25 pt. Type II – Standard Green/Gray Pressboard

All folders with 1 & 2 dividers have 2" expansion. All folders with 3 dividers have 3" expansion. Fasteners included on folder and dividers.



#### Letter

MODEL NO.	DESCRIPTION	BOX/QTY
1244-00B	Standard w/1 divider	box of 25
1245-00B	Standard w/2 dividers	box of 25
1243-00B	Standard w/3 dividers	box of 25



#### Letter

MODEL NO.	DESCRIPTION	BOX/QTY
1246-00B	Standard w/1 divider	box of 25
1247-00B	Standard w/2 dividers	box of 25
1248-00B	Standard w/3 dividers	box of 25

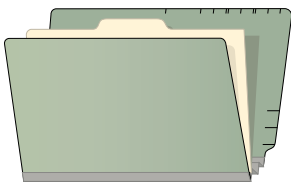

### 25 pt. Type II – 2TAB Green/Gray Pressboard

All folders with 1 & 2 dividers have 2" expansion. Fasteners included on folder and dividers.

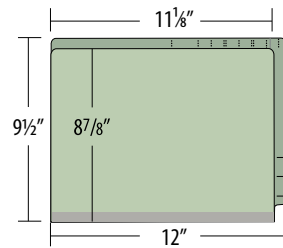

#### Letter

MODEL NO.	DESCRIPTION	BOX/QTY
1352-00B	2TAB w/1 divider	box of 25
1353-00B	2TAB w/2 dividers	box of 25

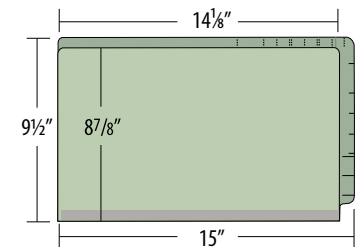

#### Legal

MODEL NO.	DESCRIPTION	BOX/QTY
1354-00B	2TAB w/1 divider	box of 25
1355-00B	2TAB w/2 dividers	box of 25

### 25 pt. Type II Color Pressboard

All folders with 1 & 2 dividers have 2" expansion. All folders with 3 dividers have 3" expansion. Fasteners included on folder and dividers.

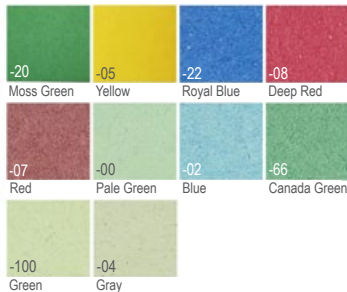

#### Letter

MODEL NO.	DESCRIPTION	BOX/QTY
1244-**B	Standard w/1 divider	box of 25
1245-**B	Standard w/2 dividers	box of 25
1243-**B	Standard w/3 dividers	box of 25
1352-**B	2TAB w/1 divider	box of 25
1353-**B	2TAB w/2 dividers	box of 25



#### Legal

MODEL NO.	DESCRIPTION	BOX/QTY
1246-**B	Standard w/1 divider	box of 25
1247-**B	Standard w/2 dividers	box of 25
1248-**B	Standard w/3 dividers	box of 25
1354-**B	2TAB w/1 divider	box of 25
1355-**B	2TAB w/2 dividers	box of 25

All color pressboard folders may require up to a 35-day lead time.

\*\*Choose appropriate color suffix:

## Alternatives to Pressboard

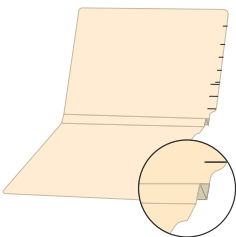

### 1 1/2" "W" Expansion

These sturdy 18 pt. manila folders have a paper W-fold on the bottom that expands to hold up to 1 1/2" of documents.

MODEL NO.	DESCRIPTION	BOX/QTY
1196-00	Letter [9 1/2" h" x 11 3/4" w x 12 1/4" w overall]	box of 50
1197-00	Legal [9 1/2" h" x 14 3/4" w x 15 1/4" w overall]	box of 50



### Classification Folder – 1 & 2 Dividers

Allows documents to be subdivided within the folder into as many as six categories. These sturdy 18 pt. manila folders expand up to 1-1/2" and have 2" bonded fasteners in positions 1 and 3 of the folder. Each divider has twin prong fastener included.

MODEL NO.	DESCRIPTION	BOX/QTY
1258-00B	Letter 9 1/2" x 11 3/4" - 12 1/4" - 1 divider	box of 25
1268-00B	Letter 9 1/2" x 11 3/4" - 12 1/4" - 2 dividers	box of 25
1259-00B	Legal 9 1/2" x 14 3/4" - 15 1/4" - 1 divider	box of 25
1269-00B	Legal 9 1/2" x 14 3/4" - 15 1/4" - 2 dividers	box of 25



## Labels

Whether you file by letter or number, GBS is sure to have a match for your existing color coded system. We have been manufacturing color coded labels since 1974. If you don't see the label you are looking for, please give us a call. Due to space limitations, we have not shown every available label. In addition to Numeric and Alphabetic labels, we also have a wide range of year codes, coding labels and name indexing label products.

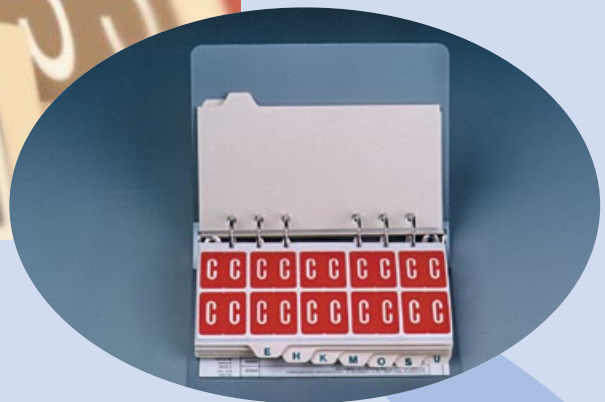

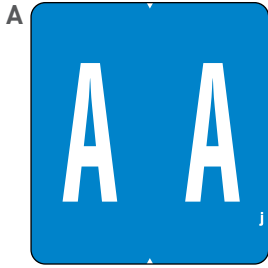

**A Color Control Labels • Alphanumeric • 1.3" H x 1.25" W**

MODEL NO.	DESCRIPTION	PACKAGE QTY.
8841	Binder for 2 <sup>nd</sup> Letter • Complete with Indexes • 1,000 Standard Proportional Assortment Labels	1000
8842	Refill for 2 <sup>nd</sup> Letter • Sheets of 1,000 Standard Proportional Assortment Labels • 6 Holes Punched for Binder	1000
8845	Binder for 1 <sup>st</sup> Letter • Complete with Indexes • 1,000 Standard Proportional Assortment Labels	1000
8846	Refill for 1 <sup>st</sup> Letter • Sheets of 1,000 Standard Proportional Assortment Labels • 6 Holes Punched for Binder	1000
8848	Package of 200 of any one Specified Label (A thru Z & Mc) • 6 Holes Punched for Binder	200
8849	Package of 200 Special Low Usage Consonant Labels	200
8850	Dispenser Box of 250 of any one Specified Label (A thru Z)	200



**B Alphanumeric Mini Labels • 1" H x 1.25" W**

MODEL NO.	DESCRIPTION	PACKAGE QTY.
8934	Dispenser Box of 250 of any one Specified Label (A thru Z) • 6 Holes Punched for Binder	200



**C & D Label Accessories**

MODEL NO.	DESCRIPTION	PACKAGE QTY.
C 8853	Label Lam Mylar Overlay • Indexing Labels Protection • 2" H x 3 1/4" W	500
D 8941	Label Lam Mylar Overlay • 8" x 2" Self Adhesive Label Protector	100





## E Prefix Labels • ½" H x 1¼" W

MODEL NO.	DESCRIPTION	PACKAGE QTY.
8816	Dispenser Box of 250 of any specified label (0-9) • Black Numbers on White Background	250
8816 Set	10 Dispenser Boxes of 250 8816 Labels (1 each, 0-9) • Black Numbers on White Background	2500



8851-24

## F Year Band Labels • System One • ¾" H x 1½" W

MODEL NO.	DESCRIPTION	PACKAGE QTY.
8851-**	Dispenser Box of 500 of any One Specified Year Band Label • Reversed Numbers	500

Replace \*\* with a year





COMPETITIVE MATCH LABELS

**Series 0200**  
Mylar Pages/Rolls - Jeter Match

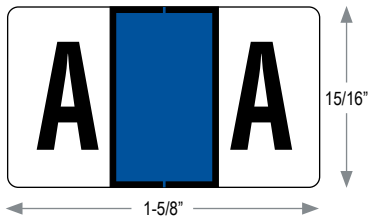

LABEL	STOCK NO.	LABEL	STOCK NO.
	pages: 0210 rolls: 0250		pages: 0224 rolls: 0264
	pages: 0211 rolls: 0251		pages: 0225 rolls: 0265
	pages: 0212 rolls: 0252		pages: 0226 rolls: 0266
	pages: 0213 rolls: 0253		pages: 0227 rolls: 0267
	pages: 0214 rolls: 0254		pages: 0228 rolls: 0268
	pages: 0215 rolls: 0255		pages: 0229 rolls: 0269
	pages: 0216 rolls: 0256		pages: 0230 rolls: 0270
	pages: 0217 rolls: 0257		pages: 0231 rolls: 0271
	pages: 0218 rolls: 0258		pages: 0232 rolls: 0272
	pages: 0219 rolls: 0259		pages: 0233 rolls: 0273
	pages: 0220 rolls: 0260		pages: 0234 rolls: 0274
	pages: 0221 rolls: 0261		pages: 0235 rolls: 0275
	pages: 0222 rolls: 0262		pages: 0236 rolls: 0276
	pages: 0223 rolls: 0263		

**STOCK NO. PRODUCT**

**0201\* Alpha Book**  
This three-ring binder contains 3,120 Alpha Codes proportioned to expected usage. Also includes 162 Year Codes and 27 each of 4 solid Color-Codes (Red, Yellow, Blue, Green) for a total of 3,390 Color-Codes. Complete set includes instructions and wall chart for color orientation.  
\* Use 2500 Series Year Code

**0202 Refill Set**  
For use with above set. Includes 3,120 Alpha Code labels proportioned to expected usage. No Year Codes, Special Codes, Binder or Index.

**(see chart) Refill Pages**  
Replacement pages for above. Sold by individual letter, 10 pages, 240 labels per poly bag. Three-hole punched.

**0290 Alpha Roll Set**  
Complete set of 27 rolls, packaged in outer box to hold rolls in an orderly manner.

**(see chart) Alpha Roll Labels**  
500 labels per roll in dispenser box.

**Series 2500/2800**  
Mylar Pages/Rolls - Jeter Match

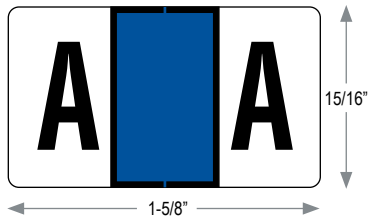

LABEL	STOCK NO.	LABEL	STOCK NO.
	pages: 2510 rolls: 2850		pages: 2524 rolls: 2864
	pages: 2511 rolls: 2851		pages: 2525 rolls: 2865
	pages: 2512 rolls: 2852		pages: 2526 rolls: 2866
	pages: 2513 rolls: 2853		pages: 2527 rolls: 2867
	pages: 2514 rolls: 2854		pages: 2528 rolls: 2868
	pages: 2515 rolls: 2855		pages: 2529 rolls: 2869
	pages: 2516 rolls: 2856		pages: 2530 rolls: 2870
	pages: 2517 rolls: 2857		pages: 2531 rolls: 2871
	pages: 2518 rolls: 2858		pages: 2532 rolls: 2872
	pages: 2519 rolls: 2859		pages: 2533 rolls: 2873
	pages: 2520 rolls: 2860		pages: 2534 rolls: 2874
	pages: 2521 rolls: 2861		pages: 2535 rolls: 2875
	pages: 2522 rolls: 2862		pages: 2536 rolls: 2876
	pages: 2523 rolls: 2863		

**STOCK NO. PRODUCT**

**2501\* Alpha Book**  
This three-ring binder contains 3,120 Alpha Codes proportioned to expected usage. Also includes 162 Year Codes and 27 each of 4 solid Color-Codes (Red, Yellow, Blue, Green) for a total of 3,390 Color-Codes. Complete set includes instructions and wall chart for color orientation.  
\* Use 2500 Series Year Code

**2502 Refill Set**  
For use with above set. Includes 3,120 Alpha Code labels proportioned to expected usage. No Year Codes, Special Codes, Binder or Index.

**(see chart) Refill Pages**  
Replacement pages for above. Sold by individual letter, 10 pages, 240 labels per poly bag. Three-hole punched.

**2890 Alpha Roll Set**  
Complete set of 27 rolls, packaged in outer box to hold rolls in an orderly manner.

**(see chart) Alpha Roll Labels**  
500 labels per roll in dispenser box.

**Series 2900**  
Mylar Pages/Rolls - Jeter Match

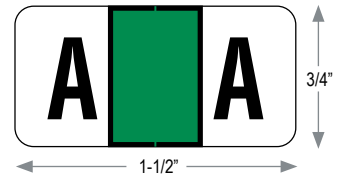

LABEL	STOCK NO.	LABEL	STOCK NO.
	pages: 2910 rolls: 2950		pages: 2924 rolls: 2964
	pages: 2911 rolls: 2951		pages: 2925 rolls: 2965
	pages: 2912 rolls: 2952		pages: 2926 rolls: 2966
	pages: 2913 rolls: 2953		pages: 2927 rolls: 2967
	pages: 2914 rolls: 2954		pages: 2928 rolls: 2968
	pages: 2915 rolls: 2955		pages: 2929 rolls: 2969
	pages: 2916 rolls: 2956		pages: 2930 rolls: 2970
	pages: 2917 rolls: 2957		pages: 2931 rolls: 2971
	pages: 2918 rolls: 2958		pages: 2932 rolls: 2972
	pages: 2919 rolls: 2959		pages: 2933 rolls: 2973
	pages: 2920 rolls: 2960		pages: 2934 rolls: 2974
	pages: 2921 rolls: 2961		pages: 2935 rolls: 2975
	pages: 2922 rolls: 2962		pages: 2936 rolls: 2976
	pages: 2923 rolls: 2963		

**STOCK NO. PRODUCT**

**2901\* Mini Alpha Book**  
**2901-A\*\* Mini Alpha Book**  
The Alpha Series is for use with smaller 9-1/2" W x 6" H folder systems or for more labeling flexibility on standard-size files. Complete set comes in a compact three-ring binder with indexes. Includes 3,105 Alpha Codes proportioned to expected usage. Also includes 162 Year Codes and 27 each of 4 Solid Color-Codes (Red, Yellow, Blue, Green) for a total of 3,375 Color-Codes. Instructions and color wall chart for orientation are included.  
\* Use 5800 Series Year Code \*\* Use 2500 Series Year Code

**2902\* Refill Set**  
For use with above set. Includes 3,105 Alpha Code labels proportioned to expected usage. No Year Codes, Special Codes, Binder or Index.

**(see chart) Refill Pages**  
Replacement pages for above. Sold by individual letter, 10 pages, 270 labels per polybag.

**2990 Mini Alpha Roll Set**  
Complete set of 27 rolls, packaged in outer box to hold rolls in an orderly manner.

**(see chart) Mini Alpha Roll Labels**  
Packaged 500 labels per roll in dispenser box.

## Series 3100 Paper Rolls – TAB Match

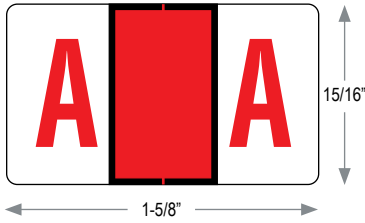

LABEL	STOCK NO.	LABEL	STOCK NO.
	rolls: 3150		rolls: 3165
	rolls: 3151‡		rolls: 3166*
	rolls: 3152		rolls: 3167**
	rolls: 3153		rolls: 3168
	rolls: 3154		rolls: 3169
	rolls: 3155*		rolls: 3170
	rolls: 3156**		rolls: 3171
	rolls: 3157		rolls: 3172
	rolls: 3158		rolls: 3173‡
	rolls: 3159		rolls: 3174
	rolls: 3160		rolls: 3175
	rolls: 3161‡		rolls: 3176
	rolls: 3162		rolls: 3177
	rolls: 3163		rolls: 3178
	rolls: 3164		

‡ Indicates Fluorescent Color

### STOCK NO. PRODUCT

**3191\* TAB Match Roll Set**  
Complete set of 27 rolls, packaged in outer box to hold rolls in an orderly manner.  
\* Blue F & O Systems (TAB Match).

**3190\*\* Jeter/TAB Match Roll Set**  
Complete set of 27 rolls, packaged in outer box to hold rolls in an orderly manner.  
\*\* Yellow F & O Systems (Jeter).

**(see chart) TAB Match Alpha Roll Labels**  
Color match TAB. Packaged 500 labels per roll in dispenser box.

## Series 3200 Kimdura Rolls – TAB Match

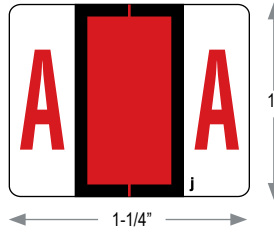

LABEL	STOCK NO.	LABEL	STOCK NO.
	rolls: 3250		rolls: 3265
	rolls: 3251‡		rolls: 3266
	rolls: 3252		rolls: 3268
	rolls: 3253		rolls: 3269
	rolls: 3254		rolls: 3270
	rolls: 3255		rolls: 3271
	rolls: 3257		rolls: 3272
	rolls: 3258		rolls: 3273‡
	rolls: 3259		rolls: 3274
	rolls: 3260		rolls: 3275
	rolls: 3261‡		rolls: 3276
	rolls: 3262		rolls: 3277
	rolls: 3263		rolls: 3278
	rolls: 3264		

‡ Indicates Fluorescent Color

### STOCK NO. PRODUCT

**3291 TAB Match Alpha Roll Set**  
Complete set of 27 rolls, packaged in outer box to hold rolls in an orderly manner.

**(see chart) TAB Match Alpha Roll Labels**  
Color match TAB. Packaged 500 labels per roll in dispenser box.

## Series 3600/6500 Mylar Rolls/pages – TAB Match

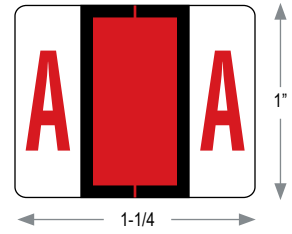

LABEL	STOCK NO.	LABEL	STOCK NO.
	rolls: 3650 pages: 6510		rolls: 3665 pages: 6524
	rolls: 3651 pages: 6511		rolls: 3666 pages: 6525
	rolls: 3652 pages: 6512		rolls: 3668 pages: 6526
	rolls: 3653 pages: 6513		rolls: 3669 pages: 6527
	rolls: 3654 pages: 6514		rolls: 3670 pages: 6528
	rolls: 3655 pages: 6515		rolls: 3671 pages: 6529
	rolls: 3657 pages: 6516		rolls: 3672 pages: 6530
	rolls: 3658 pages: 6517		rolls: 3673 pages: 6531
	rolls: 3659 pages: 6518		rolls: 3674 pages: 6532
	rolls: 3660 pages: 6519		rolls: 3675 pages: 6533
	rolls: 3661 pages: 6520		rolls: 3676 pages: 6534
	rolls: 3662 pages: 6521		rolls: 3677 pages: 6535
	rolls: 3663 pages: 6522		rolls: 3678 pages: 6536
	rolls: 3664 pages: 6523		

### STOCK NO. PRODUCT

**3691 TAB Match Alpha Roll Set**  
Complete set of 27 rolls, packaged in outer box to hold rolls in an orderly manner.

**(see chart) TAB Match Alpha Roll Labels**  
Color match TAB. Packaged 500 labels per roll in dispenser box.

**6501 TAB Match Alpha Book**  
This three-ring binder contains 3100 Alpha Codes, proportioned to expected usage.

**(see chart) TAB Match Refill Pages**  
Replacement pages for above. Sold by individual letter, 5 pages, 250 labels per polybag. Five-hole punched.

**Series 5100**  
Mylar Sheets/Rolls – TAB Match

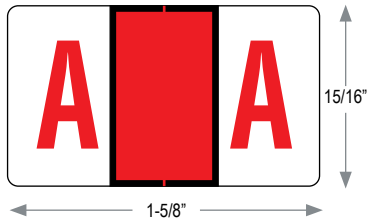

LABEL	STOCK NO.	LABEL	STOCK NO.	LABEL	STOCK NO.
	sheets: 5110 rolls: 5150		sheets: 5120 rolls: 5160		sheets: 5130 rolls: 5170
	sheets: 5111 rolls: 5151		sheets: 5121 rolls: 5161		sheets: 5131 rolls: 5171
	sheets: 5112 rolls: 5152		sheets: 5122 rolls: 5162		sheets: 5132 rolls: 5172
	sheets: 5113 rolls: 5153		sheets: 5123 rolls: 5163		sheets: 5133 rolls: 5173
	sheets: 5114 rolls: 5154		sheets: 5124 rolls: 5164		sheets: 5134 rolls: 5174
	sheets: 5115* rolls: 5155*		sheets: 5125 rolls: 5165		sheets: 5135 rolls: 5175
	sheets: 5116** rolls: 5156**		sheets: 5126* rolls: 5166*		sheets: 5136 rolls: 5176
	sheets: 5117 rolls: 5157		sheets: 5127** rolls: 5167**		sheets: 5137 rolls: 5177
	sheets: 5118 rolls: 5158		sheets: 5128 rolls: 5168		sheets: 5138 rolls: 5178
	sheets: 5119 rolls: 5159		sheets: 5129 rolls: 5169		

STOCK NO.	PRODUCT
5101*	TAB Match Alpha Kit
5102**	Jeter/TAB Match Alpha Kit 2,900 color-coding labels in a compact plastic file box. Labels proportioned based on usage. Complete with A-Z index set. * Alpha Kit-Blue F & O Systems (TAB Match) ** Alpha Kit-Yellow F & O Systems (Jeter)
5103*	TAB Match Refill Set
5104**	Jeter/TAB Match Refill Set * Refills a 5101 Alpha Kit. ** Refills a 5102 Alpha Kit. 2900 Alpha Codes
(see chart)	Refill Sheets Polybags of 225 labels of individual code.
5191*	TAB Match Alpha Roll Set
5190**	Jeter/TAB Match Alpha Roll Set * Complete set of 27 rolls, packaged in outer box to hold rolls in an orderly manner. Blue F & O Systems (TAB Match). ** Complete set of 27 rolls, packaged in outer box to hold rolls in an orderly manner. Yellow F & O Systems (Jeter).
(see chart)	Alpha Roll Labels Color match TAB. Packaged 500 labels per roll in dispenser box.

**Series 5200 Mylar Pages**  
SAFEGUARD Match

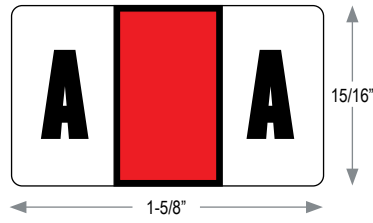

LABEL	STOCK NO.	LABEL	STOCK NO.
	pages: 5210		pages: 5224
	pages: 5211		pages: 5225
	pages: 5212		pages: 5226
	pages: 5213		pages: 5227‡
	pages: 5214‡		pages: 5228
	pages: 5215		pages: 5229
	pages: 5216		pages: 5230
	pages: 5217		pages: 5231
	pages: 5218		pages: 5232
	pages: 5219		pages: 5233
	pages: 5220		pages: 5234
	pages: 5221		pages: 5235
	pages: 5222		pages: 5236
	pages: 5223		

‡ Indicates Fluorescent Color

STOCK NO.	PRODUCT
5201	Safeguard Match Alpha Book This three-ring binder contains 3,120 Alpha Codes proportioned to expected usage, instructions and a wall chart for color orientation.
5202	Refill Set For use with above set. Includes 3,120 Alpha Code labels only. No Binder, Index, Year or Special Codes.
(see chart)	Refill Pages Replacement pages for above. Sold by individual letter, 10 pages, 240 labels per polybag. Three-hole punched.

## Series 5800/7200/7100 Mylar Pages/Rolls/Sheets - Jeter Match

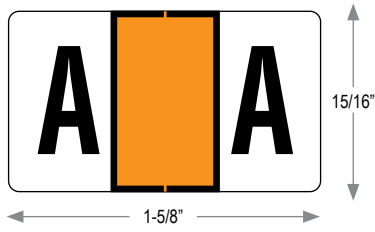

LABEL	STOCK NO.	LABEL	STOCK NO.	LABEL	STOCK NO.
	pages: 5810† rolls: 7250† sheets: 7110†		pages: 5819 rolls: 7259 sheets: 7119		pages: 5828 rolls: 7268 sheets: 7128
	pages: 5811 rolls: 7251 sheets: 7111		pages: 5820 rolls: 7260 sheets: 7120		pages: 5829 rolls: 7269 sheets: 7129
	pages: 5812 rolls: 7252 sheets: 7112		pages: 5821 rolls: 7261 sheets: 7121		pages: 5830 rolls: 7270 sheets: 7130
	pages: 5813 rolls: 7253 sheets: 7113		pages: 5822 rolls: 7263 sheets: 7123		pages: 5831 rolls: 7271 sheets: 7131
	pages: 5814 rolls: 7254 sheets: 7114		pages: 5823 rolls: 7262 sheets: 7122		pages: 5832 rolls: 7272 sheets: 7132
	pages: 5815 rolls: 7255 sheets: 7115		pages: 5824† rolls: 7264† sheets: 7124†		pages: 5833 rolls: 7273 sheets: 7133
	pages: 5816 rolls: 7256 sheets: 7116		pages: 5825 rolls: 7265 sheets: 7125		pages: 5834 rolls: 7274 sheets: 7134
	pages: 5817 rolls: 7257 sheets: 7117		pages: 5826 rolls: 7266 sheets: 7126		pages: 5835 rolls: 7275 sheets: 7135
	pages: 5818 rolls: 7258 sheets: 7118		pages: 5827 rolls: 7267 sheets: 7127		pages: 5836 rolls: 7276 sheets: 7136

† Indicates Fluorescent Color

### STOCK NO. PRODUCT

5801\* Alpha Book

5801-A\*\* Alpha Book

This three-ring binder contains 3,120 Alpha Codes proportioned to expected usage. Also includes 162 Year Codes and 27 each of 4 solid Color-Codes (Red, Yellow, Blue, Green) for a total of 3,390 Color-Codes. Complete set includes instructions and wall chart for color orientation. Also available in Series 7100 Alpha Pax and Series 7200 Alpha Rolls.

\* Use 5800 Series Year Code / \*\* Use 2500 Series Year Code

5802 Refill Set

For use with End Coder Book. Includes 3,120 Alpha Codes only. No Binder, Index, Year, or Special Codes.

(see chart) Refill Pages

Replacement pages for above. Sold by individual letter, 10 pages, 240 labels per poly bag. Three-hole punched.

7290 Alpha Roll Set

Complete set of 27 rolls, packaged in outer box to hold rolls in an orderly manner.

(see chart) Alpha Roll Labels

500 labels per roll in dispenser box.

(see chart) Alpha Sheets

This series is available only in polybag pax format. Each polybag contains 225 labels of an individual Alpha Code. No Starter Kit or Refill Kit available.

## Series 7700/8900 Mylar Pages/Rolls - Jeter Match



LABEL	STOCK NO.	LABEL	STOCK NO.
	pages: 7710 rolls: 8950		pages: 7724 rolls: 8964
	pages: 7711 rolls: 8951		pages: 7725 rolls: 8965
	pages: 7712 rolls: 8952		pages: 7726 rolls: 8966
	pages: 7713 rolls: 8953		pages: 7727 rolls: 8967
	pages: 7714 rolls: 8954		pages: 7728 rolls: 8968
	pages: 7715 rolls: 8955		pages: 7729 rolls: 8969
	pages: 7716 rolls: 8956		pages: 7730 rolls: 8970
	pages: 7717 rolls: 8957		pages: 7731 rolls: 8971
	pages: 7718 rolls: 8958		pages: 7732 rolls: 8972
	pages: 7719 rolls: 8959		pages: 7733 rolls: 8973
	pages: 7720 rolls: 8960		pages: 7734 rolls: 8974
	pages: 7721 rolls: 8961		pages: 7735 rolls: 8975
	pages: 7722 rolls: 8962		pages: 7736 rolls: 8976
	pages: 7723 rolls: 8963		

### STOCK NO. PRODUCT

7701\* Double J Alpha Book

This three-ring binder contains 3,120 Alpha Codes proportioned to expected usage. Also includes 162 Year Codes, and 27 each of 4 Solid Color-Codes (Red, Yellow, Blue, Green), for a total of 3,390 Color Codes. Complete set includes instructions and wall chart for color orientation.

\* Use 2500 Series Year Code

7702 Double J Alpha Refill Set

For use with End Coder Book. Includes 3,120 Alpha Codes only. No Binder, Index, Year or Special Codes.

(see chart) Refill Pages

Replacement Alpha Pages for End Coder Book. Alpha labels only, 10 pages, 240 labels per polybag. Three-hole punched.

8990 Double J Alpha Roll Set

Complete set of 27 rolls, packaged in outer box to hold rolls in an orderly manner.

(see chart) Double J Alpha Rolls

500 labels per roll in dispenser box.

**Series 0600**  
Mylar Rolls – TAB Match



LABEL	STOCK NO.	LABEL	STOCK NO.
	rolls: 0650		rolls: 0666
	rolls: 0651		rolls: 0668
	rolls: 0652		rolls: 0669
	rolls: 0653		rolls: 0670
	rolls: 0654		rolls: 0671
	rolls: 0655		rolls: 0672
	rolls: 0657		rolls: 0673
	rolls: 0658		rolls: 0674
	rolls: 0659		rolls: 0675
	rolls: 0660		rolls: 0676
	rolls: 0661		rolls: 0677
	rolls: 0662		rolls: 0678
	rolls: 0664		
	rolls: 0665		

**STOCK NO. PRODUCT**

**0691 TAB Match Mini Roll Set**  
Complete set of 26 rolls, packaged in outer box to hold rolls in an orderly manner.

**(see chart) TAB Match Mini Roll Labels**  
Color match TAB. Packaged 500 labels per roll in dispenser box.

**Series 7500**  
Mylar Pages - Jeter Match

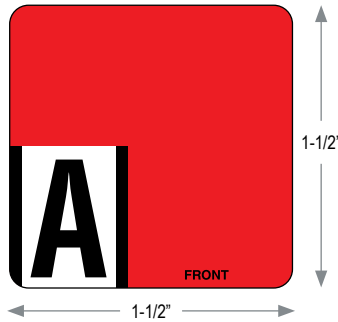

LABEL	STOCK NO.	LABEL	STOCK NO.
	pages: 7510		pages: 7524
	pages: 7511		pages: 7525
	pages: 7512		pages: 7526
	pages: 7513		pages: 7527
	pages: 7514‡		pages: 7528‡
	pages: 7515		pages: 7529
	pages: 7516		pages: 7530
	pages: 7517		pages: 7531
	pages: 7518		pages: 7532
	pages: 7519		pages: 7533
	pages: 7520		pages: 7534
	pages: 7521		pages: 7535
	pages: 7522		pages: 7536
	pages: 7523		

**STOCK NO. PRODUCT**

**7501 Top Coder Alpha Book**  
The Alpha Series is for use with standard drawer file systems. Complete set comes in a compact three-ring binder with indexes. Includes 1,950 Alpha Codes proportioned to expected usage. Also includes 162 Year Codes and 27 each of 4 Solid Color-Codes (Red, Yellow, Blue, Green) for a total of 2,200 Color-Codes. Instructions and wall chart for color orientation are included.

**7502 Refill Set**  
For use with above set. Includes 1,950 Alpha Code labels proportioned to expected usage. No Year Codes, Special Codes, Binder or Index.

**(see chart) Refill Pages**  
Replacement Alpha pages for above. Each polybag contains 225 labels on an individual Alpha Code. Three-hole punched.

‡ Indicates Fluorescent Color

## Series 0300 Mylar Rolls - Jeter Match

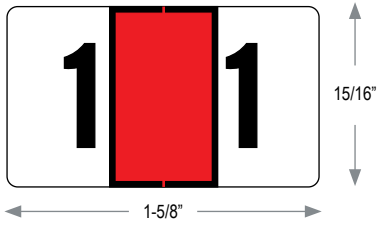

LABEL	STOCK NO.	LABEL	STOCK NO.
	rolls: 0301		rolls: 0306
	rolls: 0302		rolls: 0307
	rolls: 0303		rolls: 0308
	rolls: 0304‡		rolls: 0309
	rolls: 0305		rolls: 0310

‡ Indicates Fluorescent Color

### STOCK NO. PRODUCT

**0311 Numeric Roll Set**  
Complete set of 10 rolls, packaged in outer box to hold rolls in an orderly manner.

(see chart) **Numeric Roll Labels**  
500 labels per roll in dispenser box.

## Series 2600 Mylar Rolls - Jeter Match

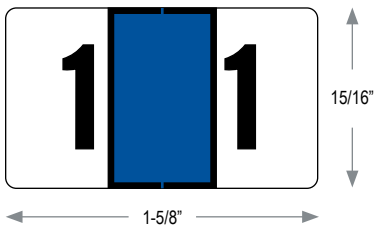

LABEL	STOCK NO.	LABEL	STOCK NO.
	rolls: 2671		rolls: 2676
	rolls: 2672		rolls: 2677
	rolls: 2673		rolls: 2678
	rolls: 2674		rolls: 2679
	rolls: 2675		rolls: 2680

### STOCK NO. PRODUCT

**2690 Numeric Roll Set**  
Complete set of 10 rolls, packaged in outer box to hold rolls in an orderly manner.

(see chart) **Numeric Roll Labels**  
500 labels per roll in dispenser box.

## Series 3000/7400 Mylar Rolls/Pages - Jeter Match

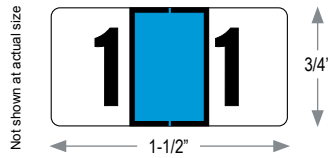

LABEL	STOCK NO.	LABEL	STOCK NO.
	rolls: 3071 pages: 7411		rolls: 3076 pages: 7416
	rolls: 3072 pages: 7412		rolls: 3077 pages: 7417
	rolls: 3073 pages: 7413		rolls: 3078 pages: 7418
	rolls: 3074 pages: 7414		rolls: 3079 pages: 7419
	rolls: 3075 pages: 7415		rolls: 3080 pages: 7410

### STOCK NO. PRODUCT

**3090 Mini Numeric Roll Set**  
Complete set of 10 rolls, packaged in outer box to hold rolls in an orderly manner. Includes a wall chart for color orientation.

(see chart) **Mini Numeric Roll Labels**  
500 labels per roll in dispenser box.

**7401 Mini Numeric Book**  
Matches the 3000 Series. Three-ring binder contains 4,050 Numeric Codes, 405 labels each. Includes instructions.

**7402 Refill Set**  
Includes 4,050 numeric codes only. No binder or index.

(see chart) **Refill Pages**  
Replacement Numeric Pages for End Coders. Numeric labels only. 10 pages, 270 labels per polybag. Three-hole punched.

## Series 3700 Mylar Rolls - TAB Match

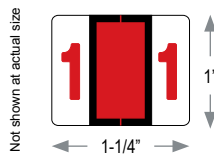

LABEL	STOCK NO.	LABEL	STOCK NO.
	rolls: 3771		rolls: 3776
	rolls: 3772		rolls: 3777
	rolls: 3773		rolls: 3778
	rolls: 3774		rolls: 3779
	rolls: 3775		rolls: 3780

### STOCK NO. PRODUCT

**3790 TAB Match Roll Set**  
Complete set of 10 rolls, packaged in outer box to hold rolls in an orderly manner.

(see chart) **TAB Match Roll Labels**  
Color match TAB. 500 labels per roll in dispenser box.

## Series 4100 Non-Mylar Rolls - TAB Match

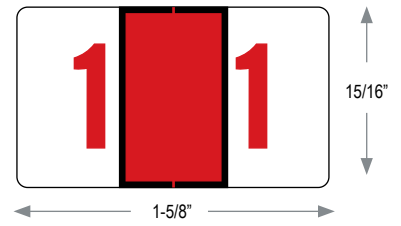

LABEL	STOCK NO.	LABEL	STOCK NO.
	rolls: 4171		rolls: 4186
	rolls: 4172		rolls: 4177
	rolls: 4173		rolls: 4178
	rolls: 4174		rolls: 4179
	rolls: 4175		rolls: 4180

### STOCK NO. PRODUCT

**4191\*/4190\*\* TAB Match Roll Set**  
Complete set of 10 rolls, packaged in outer box to hold rolls in an orderly manner.

\* Blue 6 System (TAB Match) / \*\* Yellow 6 System (Jeter)

(see chart) **TAB Match Roll Labels**  
Color match TAB. 500 labels per roll in dispenser box.

## Series 4200 Kimdura Rolls - TAB Match

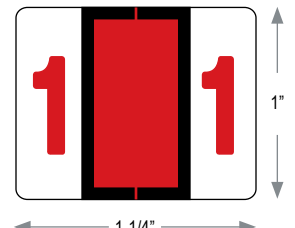

LABEL	STOCK NO.	LABEL	STOCK NO.
	rolls: 4271		rolls: 4276
	rolls: 4272‡		rolls: 4277
	rolls: 4273		rolls: 4278
	rolls: 4274		rolls: 4279
	rolls: 4275		rolls: 4280

‡ Indicates Fluorescent Color

### STOCK NO. PRODUCT

**4290 TAB Match Roll Set**  
Complete set of 10 rolls, packaged in outer box to hold rolls in an orderly manner.

(see chart) **TAB Match Roll Labels**  
Color match TAB. 500 labels per roll in dispenser box.

**Series 6100**  
Mylar Rolls – TAB Match

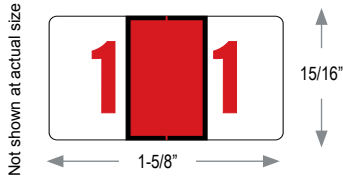

LABEL	STOCK NO.	LABEL	STOCK NO.
	rolls: 6171		rolls: 6186
	rolls: 6172		rolls: 6176
	rolls: 6182		rolls: 6177
	rolls: 6173		rolls: 6178
	rolls: 6174		rolls: 6179
	rolls: 6175		rolls: 6180

**STOCK NO. PRODUCT**  
**6191\*/6190\*\* TAB Match Roll Set**  
 Complete set of 10 rolls, packaged in outer box to hold rolls in an orderly manner.  
 \* Blue 6 System (TAB Match) / \*\* Yellow 6 System (Jeter)

(see chart) **TAB Match Roll Labels**  
 Color match TAB. 500 labels per roll in dispenser box.

**Series 7300**  
Mylar Rolls - Jeter Match

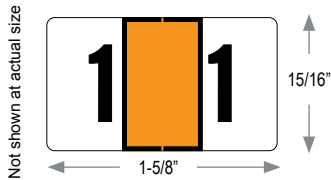

LABEL	STOCK NO.	LABEL	STOCK NO.
	rolls: 7371‡		rolls: 7376
	rolls: 7372		rolls: 7377
	rolls: 7373		rolls: 7378
	rolls: 7374		rolls: 7379
	rolls: 7375		rolls: 7380

‡ Indicates Fluorescent Color

**STOCK NO. PRODUCT**  
**7390 Numeric Roll Set**  
 Complete set of 10 rolls, packaged in outer box to hold rolls in an orderly manner.

(see chart) **Numeric Roll Labels**  
 500 labels per roll in dispenser box.

**Series 7700-R**  
Mylar Rolls - Jeter Match



LABEL	STOCK NO.	LABEL	STOCK NO.
	rolls: 7771-R		rolls: 7776-R
	rolls: 7772-R		rolls: 7777-R
	rolls: 7773-R		rolls: 7778-R
	rolls: 7774-R		rolls: 7779-R
	rolls: 7775-R		rolls: 7780-R

**STOCK NO. PRODUCT**  
**7790-R Double J Num. Roll Set**  
 Complete set of 10 rolls, packaged in outer box to hold rolls in an orderly manner.

(see chart) **Double J Num. Roll Labels**  
 500 labels per roll in dispenser box.

**Series 8000**  
Mylar Rolls – TRACO Match

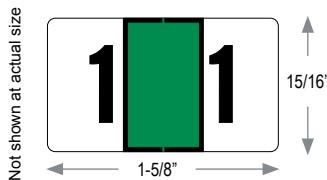

LABEL	STOCK NO.	LABEL	STOCK NO.
	rolls: 8001		rolls: 8006
	rolls: 8002		rolls: 8007
	rolls: 8003		rolls: 8008
	rolls: 8004		rolls: 8009
	rolls: 8005		rolls: 8010

**STOCK NO. PRODUCT**  
**8011 TRACO Match Num. Roll Set**  
 Complete set of 10 rolls, packaged in outer box to hold rolls in an orderly manner.

(see chart) **TRACO Match Num. Roll Lbls.**  
 Colors match TRACO systems. 500 labels per roll in dispenser box.

**Series 8800**  
Mylar Rolls/Pages - Jeter Match

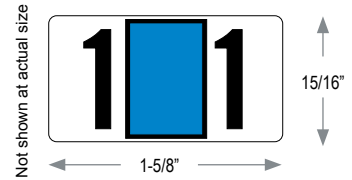

LABEL	STOCK NO.	LABEL	STOCK NO.
	rolls: 8851 pages 8871		rolls: 8856 pages 8876
	rolls: 8852 pages 8872		rolls: 8857 pages 8877
	rolls: 8853 pages 8873		rolls: 8858 pages 8878
	rolls: 8854 pages 8874		rolls: 8859 pages 8879
	rolls: 8855 pages 8875		rolls: 8860 pages 8880

**STOCK NO. PRODUCT**  
**8861 Numeric Roll Set**  
 Complete set of 10 rolls, packaged in outer box to hold rolls in an orderly manner.

(see chart) **Numeric Roll Labels**  
 500 labels per roll in dispenser box.

**8801 Numeric Book**  
 This three-binder contains 3,600 numeric codes, 360 labels each.

**8802 Refill Set**  
 Includes 3,600 numeric codes only. No binder or index.

(see chart) **Refill Pages**  
 Replacement pages. 240 labels per package. Three-hole punched.

**Series 5300 Top Code**  
Mylar Rolls - Jeter Match

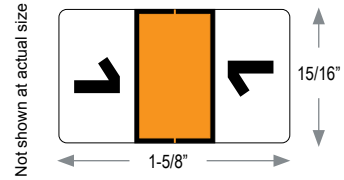

LABEL	STOCK NO.	LABEL	STOCK NO.
	rolls: 5371‡		rolls: 5376
	rolls: 5372		rolls: 5377
	rolls: 5373		rolls: 5378
	rolls: 5374		rolls: 5379
	rolls: 5375		rolls: 5380

‡ Indicates Fluorescent Color

**STOCK NO. PRODUCT**  
**5390 Top Coder Num. Roll Set**  
 Complete set of 10 rolls, package in outer box to hold rolls in an orderly manner.

(see chart) **Top Coder Num. Roll Labels**  
 For use on top tab folders. 500 labels per roll in dispenser box.

## Series 0100 Mylar Rolls - Jeter Match

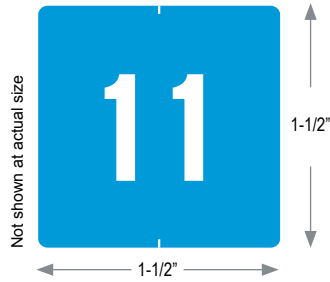

LABEL	STOCK NO.	LABEL	STOCK NO.
<b>11</b>	rolls: 0101	<b>66</b>	rolls: 0106
<b>22</b>	rolls: 0102	<b>77</b>	rolls: 0107
<b>33</b>	rolls: 0103	<b>88</b>	rolls: 0108
<b>44</b>	rolls: 0104	<b>99</b>	rolls: 0109
<b>55</b>	rolls: 0105	<b>00</b>	rolls: 0110

**STOCK NO. PRODUCT**

**0111 Numeric Roll Set**  
Complete set of 10 rolls, packaged in outer box to hold rolls in an orderly manner.

(see chart) **Numeric Roll Labels**  
500 labels per roll in dispenser box.

## Series 0700 Non-Mylar Rolls – TAB Match



LABEL	STOCK NO.	LABEL	STOCK NO.
<b>11</b>	rolls: 0771	<b>66</b>	rolls: 0776
<b>22</b>	rolls: 0772	<b>77</b>	rolls: 0777
<b>33</b>	rolls: 0773	<b>88</b>	rolls: 0778
<b>44</b>	rolls: 0774	<b>99</b>	rolls: 0779
<b>55</b>	rolls: 0775	<b>00</b>	rolls: 0780

**STOCK NO. PRODUCT**

**0791 TAB Match Mini Roll Set**  
Complete set of 10 rolls, packaged in outer box to hold rolls in an orderly manner.

(see chart) **TAB Match Mini Roll Labels**  
Color match TAB. 500 labels per roll in dispenser box.

## Series 4400 Kimdura Rolls – TAB Match



LABEL	STOCK NO.	LABEL	STOCK NO.
<b>11</b>	rolls: 4471	<b>66</b>	rolls: 4476
<b>22</b>	rolls: 4472‡	<b>77</b>	rolls: 4477
<b>33</b>	rolls: 4473	<b>88</b>	rolls: 4478
<b>44</b>	rolls: 4474	<b>99</b>	rolls: 4479
<b>55</b>	rolls: 4475	<b>00</b>	rolls: 4480

‡ Indicates Fluorescent Color

**STOCK NO. PRODUCT**

**4491 TAB Match Mini Roll Set**  
Complete set of 10 rolls, packaged in outer box to hold rolls in an orderly manner.

(see chart) **TAB Match Mini Roll Labels**  
Color match TAB. 500 labels per roll in dispenser box.

## Series 6000 Mylar Rolls – DATAFILE Match

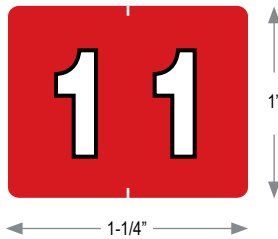

LABEL	STOCK NO.	LABEL	STOCK NO.
<b>11</b>	rolls: 6001	<b>66</b>	rolls: 6006
<b>22</b>	rolls: 6002	<b>77</b>	rolls: 6007
<b>33</b>	rolls: 6003	<b>88</b>	rolls: 6008
<b>44</b>	rolls: 6004	<b>99</b>	rolls: 6009
<b>55</b>	rolls: 6005	<b>00</b>	rolls: 6010

**STOCK NO. PRODUCT**

**6011 DATAFILE Match Roll Set**  
Complete set of 10 rolls, packaged in outer box to hold rolls in an orderly manner.

(see chart) **DATAFILE Match Roll Labels**  
Color match DATAFILE. 500 labels per roll in dispenser box.

## Series 9000 Mylar Rolls – ACME Match

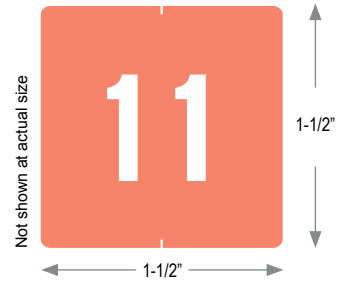

LABEL	STOCK NO.	LABEL	STOCK NO.
<b>11</b>	rolls: 9001	<b>66</b>	rolls: 9006
<b>22</b>	rolls: 9002	<b>77</b>	rolls: 9007
<b>33</b>	rolls: 9003	<b>88</b>	rolls: 9008
<b>44</b>	rolls: 9004	<b>99</b>	rolls: 9009
<b>55</b>	rolls: 9005	<b>00</b>	rolls: 9000

**STOCK NO. PRODUCT**

**9010 Acme Match Roll Set**  
Complete set of 10 rolls, packaged in outer box to hold rolls in an orderly manner.

(see chart) **Acme Match Roll Labels**  
Regular 9000 Series colors matches early ACME and SFI Coda-Color. 500 labels per roll in dispenser box.



**Series 9500**  
Mylar Rolls – AMES Match

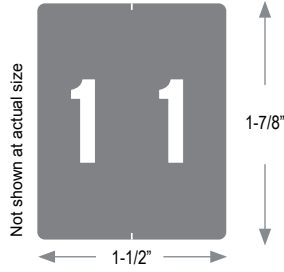

LABEL	STOCK NO.	LABEL	STOCK NO.
1 1	rolls: 9501	0 0	rolls: 9506
2 2	rolls: 9502	7 7	rolls: 9507
3 3	rolls: 9503	8 8	rolls: 9508
4 4	rolls: 9504	9 9	rolls: 9509
5 5	rolls: 9505	0 0	rolls: 9500

**STOCK NO. PRODUCT**

**9510 AMES Match Roll Set**  
Complete set of 10 rolls, packaged in outer box to hold rolls in an orderly manner.

(see chart) **AMES Match Roll Labels**  
Regular 9500 Series color match AMES. 500 labels per roll in dispenser box.

**Series 9500-A**  
Non-Mylar Rolls – AMES Match

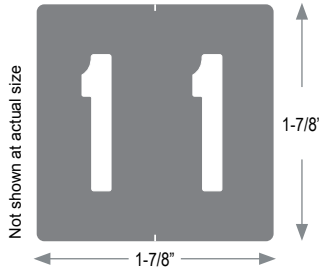

LABEL	STOCK NO.	LABEL	STOCK NO.
1 1	rolls: 9501-A	6 6	rolls: 9506-A
2 2	rolls: 9502-A	7 7	rolls: 9507-A
3 3	rolls: 9503-A	8 8	rolls: 9508-A
4 4	rolls: 9504-A	9 9	rolls: 9509-A
5 5	rolls: 9505-A	0 0	rolls: 9500-A

**STOCK NO. PRODUCT**

**9510-A AMES Match Roll Set**  
Complete set of 10 rolls, packaged in outer box to hold rolls in an orderly manner.

(see chart) **AMES Match Roll Labels**  
The “-A” Series matches larger Ames characters. 500 labels per roll in dispenser box.

**Series 9700**  
Mylar Rolls – SFI Match

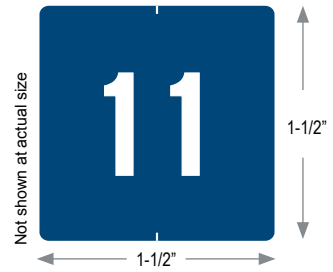

LABEL	STOCK NO.	LABEL	STOCK NO.
1 1	rolls: 9701	0 0	rolls: 9706
2 2	rolls: 9702	7 7	rolls: 9707
3 3	rolls: 9703	8 8	rolls: 9708
4 4	rolls: 9704	9 9	rolls: 9709
5 5	rolls: 9705	0 0	rolls: 9700

**STOCK NO. PRODUCT**

**9710 SFI Match Roll Set**  
Complete set of 10 rolls, packaged in outer box to hold rolls in an orderly manner.

(see chart) **SFI Match Roll Labels**  
Colors match Coda-Color/SFI Systems. 500 labels per roll in dispenser box.

**Series 9600**  
Mylar Rolls – ACME Match

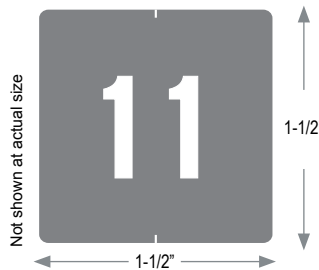

LABEL	STOCK NO.	LABEL	STOCK NO.
1 1	rolls: 9601	6 6	rolls: 9606
2 2	rolls: 9602	7 7	rolls: 9607
3 3	rolls: 9603	8 8	rolls: 9608
4 4	rolls: 9604	9 9	rolls: 9609
5 5	rolls: 9605	0 0	rolls: 9600

**STOCK NO. PRODUCT**

**9610 GBS Match Roll Set**  
Complete set of 10 rolls, packaged in outer box to hold rolls in an orderly manner.

(see chart) **GBS Match Roll Labels**  
Colors match DIEBOLD System ovals. 500 labels per roll in dispenser box.

**Series 4500**  
Mylar Rolls – Black on White - Jeter Match

**Series 4500**

LABEL	STOCK NO.	LABEL	STOCK NO.
1 1	rolls: 4501	7 7	rolls: 4507
2 2	rolls: 4502	8 8	rolls: 4508
3 3	rolls: 4503	9 9	rolls: 4509
4 4	rolls: 4504	0 0	rolls: 4500
5 5	rolls: 4505		
6 6	rolls: 4506		

**STOCK NO. PRODUCT**

**4510 Numeric Roll Set**  
Complete set of 10 rolls, packaged in outer box to hold rolls in an orderly manner.

(see chart) **Numeric Roll Labels**  
Actual Size: 1-1/2" w. x 3/4" h. All labels have the digit printed in black on a white field. Convenient for use when all digits of a number set need to be shown, but not necessarily color-coded. 500 labels per roll in dispenser box.

## Series 4600 Mylar Rolls - Jeter Match



LABEL	STOCK NO.	LABEL	STOCK NO.
	00-09 4600		50-59 4650
	10-19 4610		60-69 4660
	20-29 4620		70-79 4670
	30-39 4630		80-89 4680
	40-49 4640		90-99 4690

**STOCK NO. PRODUCT**

**4691 Double-Digit Num. Roll Set**  
Complete set of 10 rolls, packaged in outer box to hold rolls in an orderly manner.

**(see chart) Double-Digit Num. Roll Labels**  
Double-Digit labels for coding the tens and unit digits in straight numeric filing systems. Colors are keyed to 9000 Series labels. Ten colors, first label numbered 00, then 01 thru 09. Each series repeats 50 times per roll. 500 labels per roll in dispenser box.

## Series 7600 Mylar Rolls/Pages - Jeter Match

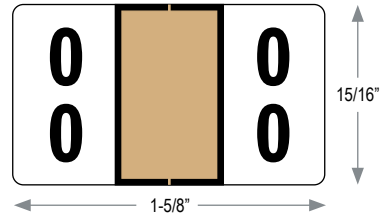

LABEL	STOCK NO.
	00-09 7600
	10-19 7610‡
	20-29 7620
	30-39 7630
	40-49 7640
	50-59 7650
	60-69 7660
	70-79 7670
	80-89 7680
	90-99 7690

‡ Indicates Fluorescent Color

**STOCK NO. PRODUCT**

**7691 Double-Digit Num. Roll Set**  
Complete set of 10 rolls, 00 thru 99, packaged in outer box to hold rolls in an orderly manner.

**(see above) Double-Digit Num. Roll Labels**  
Double-digit labels for coding the tens and unit digits in straight numeric filing systems. Colors are keyed to 7300 Series labels. Ten colors. First label numbered 00, then 01 thru 09. Each series repeats 50 times per roll. 500 labels per roll in dispenser box.

**(see below) Double Digit Pages**  
7600 Series labels are also available in pages. There are two numbers per page: 00-01, 02-03, etc. Each page has 24 labels. Each package contains 10 pages of labels. Colors keyed to 7300 Series.

NUMBER	STOCK NO.	COLOR	NUMBER	STOCK NO.	COLOR
00-01	7600-01	tan	50-51	7650-51	red
02-03	7602-03	tan	52-53	7652-53	red
04-05	7604-05	tan	54-55	7654-55	red
06-07	7606-07	tan	56-57	7656-57	red
08-09	7608-09	tan	58-59	7658-59	red
10-11	7610-11	fl. orange	60-61	7660-61	light green
12-13	7612-13	fl. orange	62-63	7662-63	light green
14-15	7614-15	fl. orange	64-65	7664-65	light green
16-17	7616-17	fl. orange	66-67	7666-67	light green
18-19	7618-19	fl. orange	68-69	7668-69	light green
20-21	7620-21	dk. green	70-71	7670-71	black
22-23	7622-23	dk. green	72-73	7672-73	black
24-25	7624-25	dk. green	74-75	7674-75	black
26-27	7626-27	dk. green	76-77	7676-77	black
28-29	7628-29	dk. green	78-79	7678-79	black
30-31	7630-31	purple	80-81	7680-81	yellow
32-33	7632-33	purple	82-83	7682-83	yellow
34-35	7634-35	purple	84-85	7684-85	yellow
36-37	7636-37	purple	86-87	7686-87	yellow
38-39	7638-39	purple	88-89	7688-89	yellow
40-41	7640-41	light blue	90-91	7690-91	dark blue
42-43	7642-43	light blue	92-93	7692-93	dark blue
44-45	7644-45	light blue	94-95	7694-95	dark blue
46-47	7646-47	light blue	96-97	7696-97	dark blue
48-49	7648-49	light blue	98-99	7698-99	dark blue

**Year Labels**  
Mylar Rolls/Pages - Jeter Match

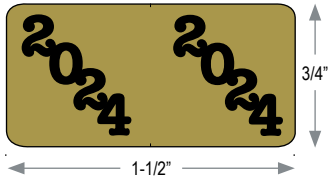

STOCK NUMBER			
ROLLS	PAGES	YEAR	COLOR (bkgnd/type)
2021YB	5821YB	2021	yellow/black
2022YB	5822YB	2022	red/black
2023YB	5823YB	2023	purple/black
2024YB	5824YB	2024	gold/black
2025YB	5825YB	2025	black/white
2026YB	5826YB	2026	orange/black
2027YB	5827YB	2027	white/black
2028YB	5828YB	2028	teal/white
2029YB	5829YB	2029	gray/white
2030YB	5830YB	2030	dark blue/white

**STOCK NO. PRODUCT**

**(see chart) Year Label Rolls**

Year labels are a great help in the retirement of old records. Their colors identify quickly and accurately which files are inactive. 500 labels per roll in dispenser box.

**(see chart) Year Label Pages**

For use in Jeter End Coder Books. 15 pages, 405 labels per polybag.

**Year Labels**  
Mylar Rolls/Pages - Jeter Match

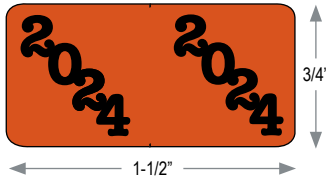

STOCK NUMBER			
ROLLS	PAGES	YEAR	COLOR (bkgnd/type)
2021YB-A	2521YB	2021	black/white
2022YB-A	2522YB	2022	pink/black
2023YB-A	2523YB	2023	light blue/black
2024YB-A	2524YB	2024	red/black
2025YB-A	2525YB	2025	grass green/black
2026YB-A	2526YB	2026	gray/white
2027YB-A	2527YB	2027	purple/white
2028YB-A	2528YB	2028	white/black
2029YB-A	2529YB	2029	orange/black
2030YB-A	2530YB	2030	yellow/black

**STOCK NO. PRODUCT**

**(see chart) Alternate Color Label Rolls**

500 labels per roll in dispenser box.

**(see chart) Alternate Color Book Pages**

405 labels in polybag, three-hole punched.

**Year Labels**  
Mylar Rolls - Jeter Match

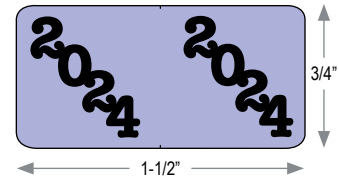

STOCK NUMBER		
ROLLS	YEAR	COLOR (bkgnd/type)
2021YB-R	2021	seafoam green/white
2022YB-R	2022	dark blue/white
2023YB-R	2023	light mint/black
2024YB-R	2024	lavender/black
2025YB-R	2025	copper/black
2026YB-R	2026	fluorescent pink ‡/black
2027YB-R	2027	lime green ‡/white
2028YB-R	2028	dark green/white
2029YB-R	2029	light blue/white
2030YB-R	2030	magenta/black

‡ Indicates Fluorescent Color

**STOCK NO. PRODUCT**

**(see chart) Year Label Rolls**

500 labels per roll in dispenser box.

**Top Code Year Labels**  
Non-Mylar Pages - Jeter Match

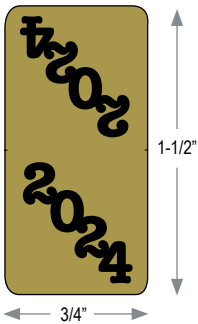

STOCK NUMBER		
PAGES	YEAR	COLOR (bkgnd/type)
7521YB	2021	yellow/black
7522YB	2022	red/black
7523YB	2023	purple/black
7524YB	2024	gold/black
7525YB	2025	black/white
7526YB	2026	orange/black
7527YB	2027	white/black
7528YB	2028	teal/white
7529YB	2029	gray/white
7530YB	2030	dark blue/white

**STOCK NO. PRODUCT**

**(see chart) Book Pgs. - Top Coder Labels**

For use with drawer file systems. In pages only, 405 labels per polybag.

**Month/Year Labels**  
Mylar Pages - Jeter Match

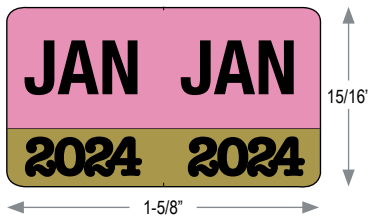

NO. (pgs)	MONTH/YEAR	NO. (pgs)	MONTH/YEAR
22401MY	Jan. 2023	22407MY	July 2023
22402MY	Feb. 2023	22408MY	Aug. 2023
22403MY	Mar. 2023	22409MY	Sept. 2023
22404MY	Apr. 2023	22410MY	Oct. 2023
22405MY	May 2023	22411MY	Nov. 2023
22406MY	June 2023	22412MY	Dec. 2023

**STOCK NO. PRODUCT**

**22491MY Month/Year Page Set**

Complete set of 2024 Month/Year Codes. 12 packages, 2,700 labels.

**(see chart) Month/Year Page Labels**

These labels color-code the month and year for the dating of records, simplifying purging. Month/Year coding is also used for recall system. Nine labels per sheet, 225 like labels per polybag. Order individual Month/Year packages or a complete 12.

**22413MY Month/Year Convenience Pack**

2024 Month/Year Labels. 18 labels for each month of the year. 216 labels total. For stock number, use the first and last digits of year followed by number 21MY.

## Year Labels Mylar Rolls – AMES Match

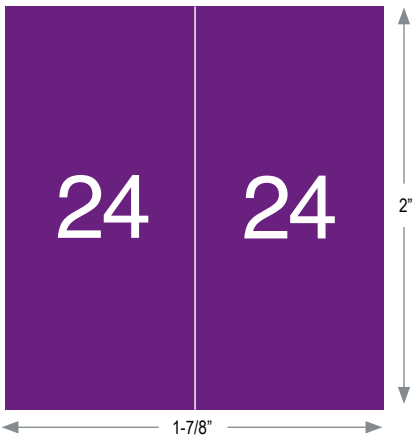

STOCK NO.	YEAR	COLOR
2021YBAX	2021	gray
2022YBAX	2022	blue
2023YBAX	2023	orange
2024YBAX	2024	purple
2025YBAX	2025	black
2026YBAX	2026	yellow
2027YBAX	2027	brown
2028YBAX	2028	pink
2029YBAX	2029	green
2030YBAX	2030	red

**STOCK NO. PRODUCT**

(see chart) **Ames Match Year Label Rolls**  
500 labels per roll in dispenser box.

## Series 4800 Labels Kimdura Rolls – TAB Match



STOCK NO.	MONTH	COLOR	STOCK NO.	MONTH	COLOR
4801	Jan.	green	4807	July	red
4802	Feb.	dk. blue	4808	Aug.	yellow
4803	Mar.	blue	4809	Sept.	salmon
4804	April	brown	4810	Oct.	orange
4805	May	black	4811	Nov.	purple
4806	June	gray	4812	Dec.	lt. green

**STOCK NO. PRODUCT**

**4891 TAB Match Mini Mth. Roll Set**  
Complete set of 12 rolls, packaged in outer box to hold rolls in an orderly manner.

(see chart) **TAB Match Mini Mth. Roll Lbls.**  
Color match TAB. Kimdura stock. Packaged 500 labels per roll in dispenser box.

## Series 4100 Year Labels Kimdura Rolls – TAB Match

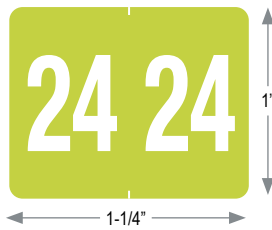

STOCK NO.	YEAR	COLOR
4121YB	2021	red/white
4122YB	2022	light orange
4123YB	2023	gray
4124YB	2024	light green
4125YB	2025	dark green
4126YB	2026	blue
4127YB	2027	purple
4128YB	2028	lavender
4129YB	2029	brown
4130YB	2030	pink

**STOCK NO. PRODUCT**

(see chart) **TAB Match Year Label Rolls**  
Color match TAB. Kimdura stock. Packaged 500 labels per roll in dispenser box.

## Month Labels Mylar Pages – Jeter Match

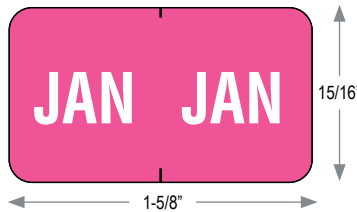

STOCK NO.	MONTH	COLOR	STOCK NO.	MONTH	COLOR
0001	Jan.	pink	0007	July	blue
0002	Feb.	red	0008	Aug.	black
0003	Mar.	yellow	0009	Sept.	dk. blue
0004	April	lavender	0010	Oct.	white
0005	May	orange	0011	Nov.	purple
0006	June	green	0012	Dec.	gold

**STOCK NO. PRODUCT**

**0013 Month Page Set**  
Complete Month Code Set. Includes a binder with indexes January through December. Five pages of 24 labels, January through December, for a total of 1,440 labels.

(see chart) **Month Page Labels**  
All new colors are available for this important series of month labels. Best used with the new Birth Date systems. Packaged in pages, 240 like labels per polybag.

## Series 4000 Year Labels Kimdura Rolls – TAB Match

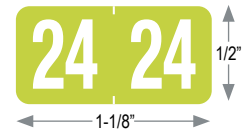

STOCK NO.	YEAR	COLOR
4021YB	2021	red/white
4022YB	2022	light orange
4023YB	2023	gray
4024YB	2024	light green
4025YB	2025	dark green
4026YB	2026	blue
4027YB	2027	purple
4028YB	2028	lavender
4029YB	2029	brown
4030YB	2030	pink

**STOCK NO. PRODUCT**

(see chart) **TAB Match Mini Yr. Label Rolls**  
Color match TAB. Kimdura stock. Packaged 500 labels per roll in dispenser box.

## Month Labels Mylar Sheets – Jeter Match

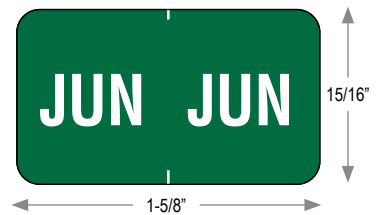

STOCK NO.	MONTH	COLOR	STOCK NO.	MONTH	COLOR
7001	Jan.	lavender	7007	July	red
7002	Feb.	lt. org.	7008	Aug.	salmon
7003	Mar.	yellow	7009	Sept.	lt. green
7004	April	blue	7010	Oct.	purple
7005	May	gray	7011	Nov.	dk. org.
7006	June	green	7012	Dec.	brown

**STOCK NO. PRODUCT**

**7091 Month Sheet Set**  
Complete Month Code Set. 12 packages – 7001 thru 7012. 2,700 labels.

(see chart) **Month Pages Labels**  
For coding all 12 months each with its own color. Colors are the same as in Month/Year Codes. Order individual month or complete sets, January through December. 9 sheets, 225 like labels per polybag.

**7013 Month Convenience Pack**  
Package of label sheets. 18 labels for each month of the year. 216 labels total.

**Medicaid/Medicare Labels**  
Mylar Sheets/Pages - Jeter Match

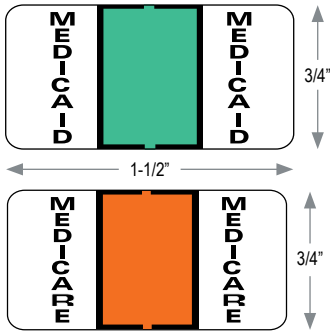

STOCK NO.	PRODUCT
7106	<b>Medicaid</b> (aqua) Format: Sheets for end tab kits. (240 labels total)
5806	<b>Medicaid</b> (aqua) Format: Pages for end code books. (270 labels total)
7107	<b>Medicare</b> (orange) Format: Sheets for end tab kits. (240 labels total)
5807	<b>Medicare</b> (orange) Format: Pages for end code books. (270 labels total)

**Write-In Boxes**

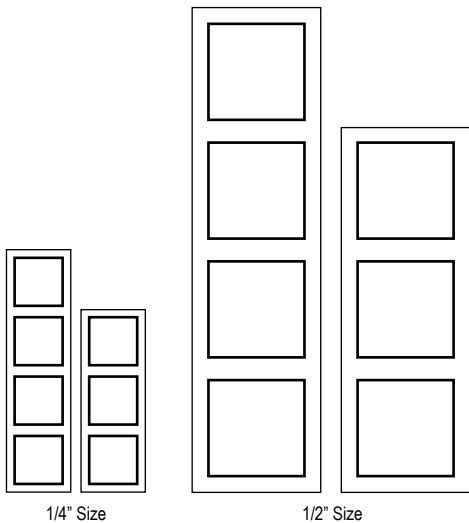

STOCK NO.	PRODUCT	ITEM
0112	<b>Write-In Boxes</b> (1/4")	2 Box
0113	<b>Write-In Boxes</b> (1/4")	3 Box
0114	<b>Write-In Boxes</b> (1/4")	4 Box
1113	<b>Write-In Boxes</b> (1/2")	3 Box
1114	<b>Write-In Boxes</b> (1/2")	4 Box

Use these labels to cover digits so you can reuse folders with a new number. One label for each side of folder tab. Labels match our standard strip label write-in boxes. All labels packaged 250 per roll.

**Medical Labels**  
Non-Mylar Rolls/Pages - Jeter Match

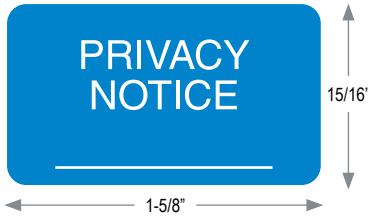

STOCK NO.	PRODUCT
PRIVACY	<b>Privacy Notice</b> (blue) Format: Rolls (500 labels total - Non-Mylar)

**Series 9500**  
Solid Coding Labels - Mylar Rolls

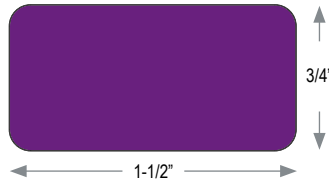

STOCK NO.	COLOR	STOCK NO.	COLOR
9520	red	9528	pink
9521	gray taupe	9529	green
9522	blue	9530	white
9523	orange	9532	true gray
9524	purple	9533	gold
9525	black	9534	fl. orange
9526	yellow	9535	tan
9527	brown		

STOCK NO.	PRODUCT/COLOR
9531	<b>Solid Color Roll Set</b> Complete set of rolls of first 12 colors, packaged in outer box to hold rolls in an orderly manner.
(see chart)	<b>Solid Color Roll Labels</b> For both end code and top code systems. Ideal for special coding requirements. 500 labels per roll in dispenser box.

**Series 5300**  
Solid Coding Labels - Mylar Pages

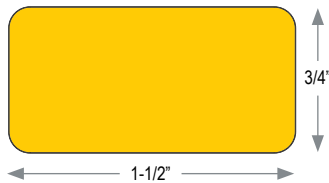

STOCK NO.	PRODUCT/COLOR
5320	<b>Red</b>
5322	<b>Blue</b>
5326	<b>Yellow</b>
5329	<b>Green</b>

Solid color labels available in pages for both end code and tope code systems. Three-hole punched for use in binder. 405 labels, packaged in polybag. Four colors only.

**Allergy Labels**  
Mylar/Non-Mylar Rolls/Sheets/Pages

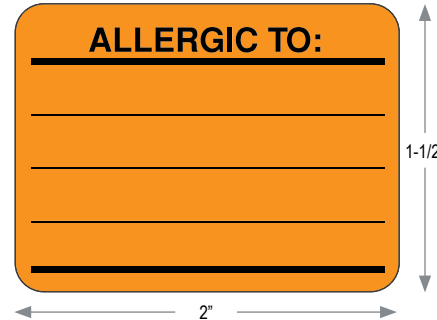
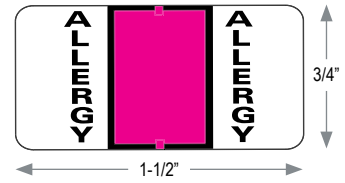

STOCK NO.	PRODUCT
7108	<b>Allergy Labels</b> (flourescent pink) Format: Sheets for end tab kits. (240 labels total)
5808	<b>Allergy Labels</b> (flourescent pink) Format: Pages for end code books. (270 labels total)
ALLERGY-SMALL	<b>Allergy Labels</b> (flourescent orange) Format: Roll format. (500 labels total)
ALLERGY-LARGE	<b>Allergy Labels</b> (flourescent orange) Format: Roll format. (500 labels total)

## Series 6200 Mini-Solid – Removable Rolls



STOCK NO.	PRODUCT/COLOR
6220	Red
6222	Dark Blue
6226	Yellow
6229	Green
6230	Orange

Solid colors indicate specific classifications of records. Removable adhesive back permits easy label change when classifications change. 2,000-label rolls.

## Series 6300 Mini-Solid – Non-Mylar Rolls

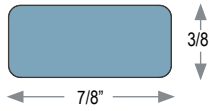

STOCK NO.	PRODUCT/COLOR
6313	Light Blue
6320	Red
6322	Dark Blue
6323	Orange
6324	Purple
6325	Black
6326	Yellow
6327	Brown
6329	Green

Mini-size special coding labels available in seven colors. Special latex-based paper stock ensures excellent adhesion. Dispenser box contains 2,000 labels.

## Protect Labels Clear Mylar

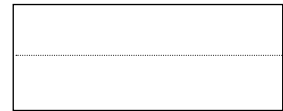

STOCK NO.	PRODUCT
1835	<b>Mylar Protect Label</b> Original standard 3-1/2" w x 1-3/4" h. Seals typed name labels under clear Mylar film to prevent peeling, tearing and smudging. Wrap-around design strengthens the folder edge. 500 per package.
1935	<b>Mini Mylar Protect Label</b> Mini size 2-1/2" w x 1-3/4" h. Seals typed Mini Name Labels No. 1820 or 1821. 500 per package.
1735	<b>Large Mylar Protect Label</b> Large size 5-1/4" w x 1-3/4" h. Label extends past name label where a year band or other code can be placed on top for easy removal. Also used for reinforcement of high activity folders. 500 per package.
2035	<b>X-Large Mylar Protect Label</b> Same as above, except in extra-large size: 8" w x 1-3/4" h. 500 per package.
2035-100	<b>X-Large Mylar Protect Label</b> Same as above, except 100 per package.

## Name Labels

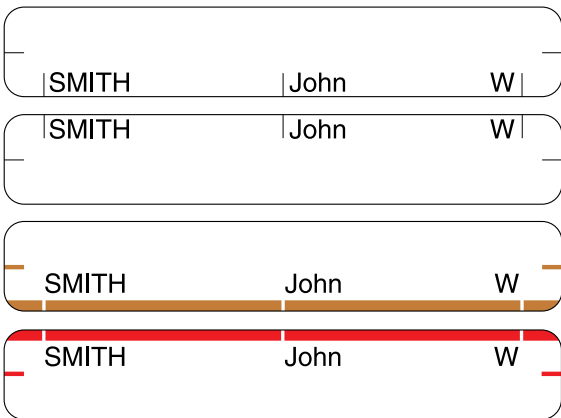

Stock No.	Color
1800	white
1801	green
1802	tan
1804	orange
1805	red
1806	purple
1809	yellow
1811	dark blue

Full label size: 3-1/2" w x 5/8" h (not shown at actual size)

STOCK NO.	PRODUCT
1854	<b>Plain White</b> Fan-folded and perforated for separation. Complete instructions for correct usage on both end tab and top tab folders. Two-across labels speed folder preparation. Pin fed for computer printers. Double-feed, 1,000 per package.
1851	<b>Alignment Marks – Single Feed</b>
1852	<b>Alignment Marks – Double Feed</b> Same as above, except includes alignment marks. Stock No. 1852 comes pin fed for computer printers. 1,000 per package.

**LZR-LABEL Laser Printer – Plain White**  
Plain white name labels on 8-1/2" x 11" sheets with 30 labels per page. Packaged in a polybag to resist warpage. For use in laser printers. 50 sheets, 1,500 per package. In Word-Avery Format #5266

**(see chart) Color Striped**  
Color striped, fan-folded and perforated for separation. Complete instructions for correct usage on both end tab and top tab folders. Single-feed, 250 per package.

STOCK NO.	PRODUCT
1820	<b>Mini-Plain White</b> 2-1/2" w x 5/8" h Mini name labels, plain white without alignment marks. Fan folded and perforated. Pin fed for computer printers. Double fee, 1,000 per package.
1821	<b>Mini-Alignment Marks</b> 2-1/2" w x 5/8" h White mini name labels with alignment marks. Fan folded and perforated. Pin fed for computer printers. Double fee, 1,000 per package.

## Jeter Create-A-Tab

If you need to change your top tab folders to end tab, Create-A-Tabs provide a unique solution. Jeter offers two styles of Create-A-Tabs, which allow you to attach a pressure-sensitive tab to the end of your top tab file folder. Create-A-Tabs are stock items. They have a crack-and-peel backer, which makes them easy to apply to file folders. Create-A-Tabs will adhere securely to most file folder surfaces, depending upon the condition of the file folder.

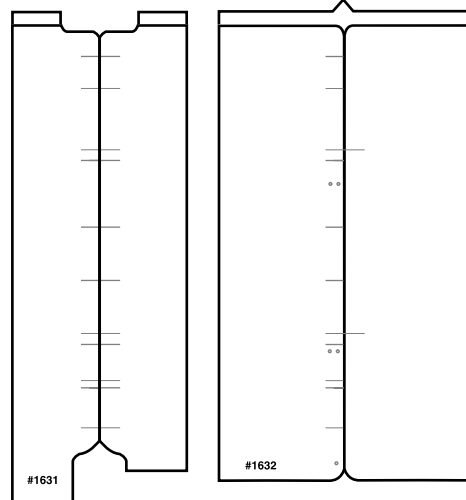

STOCK NO.	PRODUCT
1631	<b>Jeter Create-A-Tab</b> Pressure-sensitive tab that attaches to a top tab, drawer style folder to create an end code folder. Package of 200.
1632	<b>Jeter Create-A-Tab II</b> This larger Create-A-Tab has a tab shape that matches our Super Coder folders. Package of 200.



## Dividers and Indexes

A wide range of custom and stock divider and index products are offered to provide you with different organizational tools. The item will allow you to organize information within your files, so the information is where you want it, when you need it.

**Five Color Dividers, Shelf Stock • Blank Fifth Cut Tabs • 100 Lbs. Tufdex**

MODEL NO.	DESCRIPTION	CARTON QTY.	CARTON WT.
8630	Bottom Tab • 8½" W x 11" H plus ¾" Tab Extension • Collated into sets of Five Positions and Colors • 50 Sets of Five per Package	250	6 Lbs.



## INTRODUCING Three New Standard Health Care Title Sets

Available in styles A, B & C

90# manila stock; 1/2" tab extension;  
collated into sets.  
End tab is blank for easy-to-write titles.

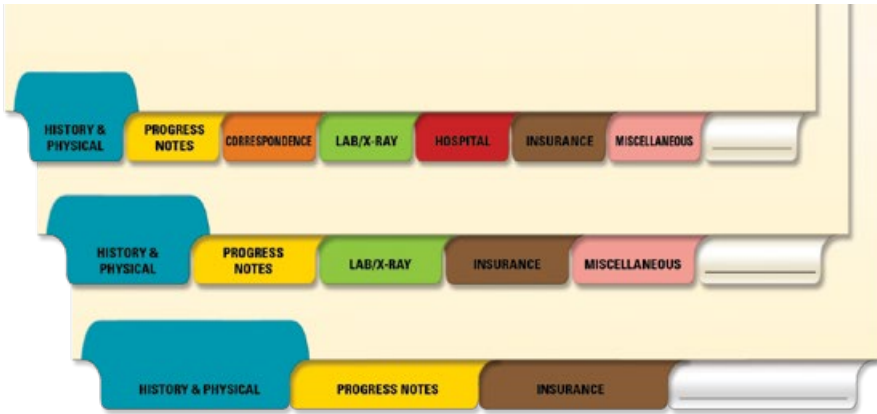

**MODEL NO. TABS STYLE**

MODEL NO.	TABS	STYLE
TI52008	8-Tabs	Style A
TI54008	8-Tabs	Style B
TI56008	8-Tabs	Style C
TI52006	6-Tabs	Style A
TI54006	6-Tabs	Style B
TI56006	6-Tabs	Style C
TI52004	4-Tabs	Style A
TI54004	4-Tabs	Style B
TI56004	4-Tabs	Style C



Minimum order quantity is a set of 50 indexes.



Indexes



**INDEX A**  
 8 1/2" w x 11 1/2" h  
 90# White  
 90# Manila  
 Fasteners N/A

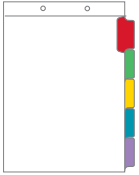

**INDEX B**  
 9" w x 11" h  
 90# White  
 90# Manila  
 Fasteners N/A

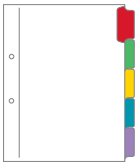

**INDEX C**  
 9" w x 11" h  
 90# White  
 90# Manila  
 Fasteners N/A

Bottom Tabs

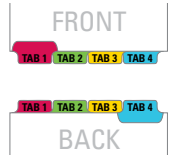

**Top Hinge A, D  
 Print Style A**  
 Same Print, both sides (standard)  
 Print front only  
 No print on Tabs

Side Tabs



**Top Hinge B, E  
 Print Style B**  
 Same Print, both sides (standard)  
 Print front only  
 No print on Tabs



**Side Hinge C, F, Duotab  
 Print Style C**  
 Same Print, both sides (standard)  
 Print front only  
 No print on Tabs

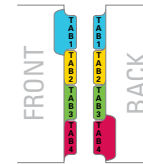

**Print Style D**  
 Same Print, both sides (standard)  
 Print front only  
 No print on Tabs

Tab Size

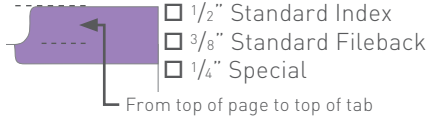

Quantity

No. of Tabs	No. of Sets	Total Tabs

**Cut**  Letter size  Legal size

**Collate** Tabs into Sets?

**Install** Tabs into Folders?

Bind Edge Reinforcement

Yes (standard)  No Reinforcement

Drilling

- Indexes: 2 holes (5/16")
- Filebacks: 2 slots (1/4")
- 2 3/4" centers, standard
- Special: \_\_\_\_\_

Printing

Font: **Helvetica Bold** (standard)  
 Style:  ALL CAPS  Initial Caps  
 Body Print:  
 Body Print – PDF Provided  
 Dealer Reorder Information:  
 \_\_\_\_\_

NOTE: If no selection is made, your order will be produced using the "Standard" choice unless a sample is provided, which we will match exactly.

Filebacks

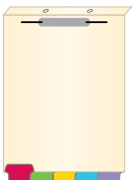

**FILEBACK D**  
 8 1/2" w x 12 1/2" h  
 1" hinge  
 110# Manila  
 No Fasteners  
 2" Fastener

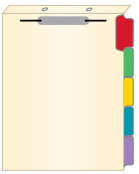

**FILEBACK E**  
 9" w x 12" h  
 1" hinge  
 110# Manila  
 No Fasteners  
 2" Fastener



**FILEBACK F**  
 10" w x 11" h  
 1" hinge  
 110# Manila  
 No Fasteners  
 2" Fastener

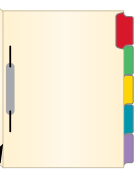

**FILEBACK DUOTAB**  
 10" w x 11" h  
 1" hinge  
 110# Manila  
 No Fasteners  
 2" Fastener (front & back)  
 (Reinforced Bind Edge N/A)  
 Pressure Sensitive Tape

Please indicate if you would like the fastener installed in another position than shown above.

Tab Copy

Position	Text	Color/No.
<b>SAMPLE</b>	<b>Correspondence</b>	<b>Blue/MY425</b>
1		
2		
3		
4		
5		
6		
7		
8		
9		
10		
11		
12		

Special Instructions:



To order call # 888-822-9777 or email [csquotes@tab.com](mailto:csquotes@tab.com)



## Outguides

OutGuides will help speed up filing and retrieval functions.



### Vinyl Outguides

Prevent lost files, lost information and search time by using outguides to identify folders removed from the system. Use a charge out slip to identify who has the file. Included is space to file trailing documents, allowing effective interfiling when the folder returns to file. Eliminate stacks of documents at your records desk to be filed.

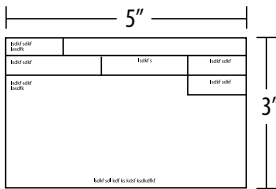
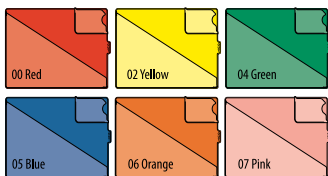

### Charge-Out Slips

MODEL NO.	DESCRIPTION
4368-00	Charge-Out Slips

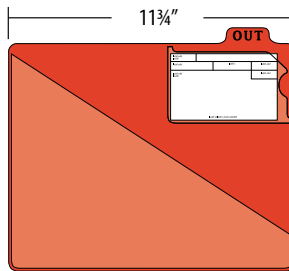

MODEL NO.	DESCRIPTION
4370-00	Outguide

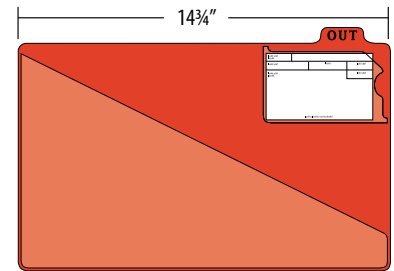

MODEL NO.	DESCRIPTION
4388-00	Outguide

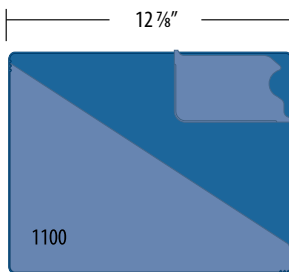

MODEL NO.	DESCRIPTION
1100-**	Middle Tab
Replace ** with a color number	

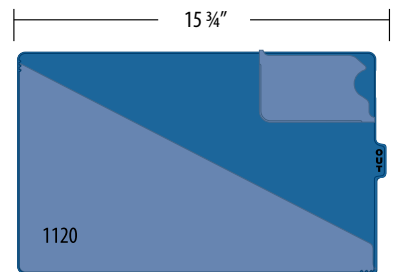

MODEL NO.	DESCRIPTION
1120-**	Middle Tab
Replace ** with a color number	

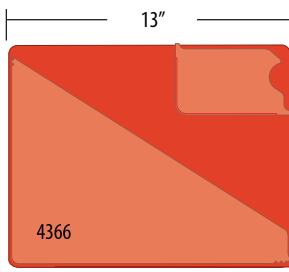

MODEL NO.	DESCRIPTION
4366-**	Lower Tab
Replace ** with a color number	

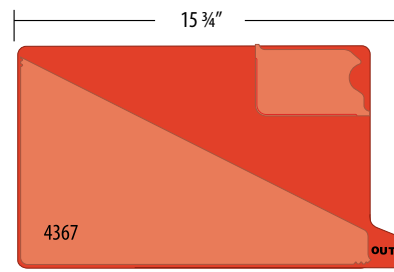

MODEL NO.	DESCRIPTION
4367-**	Lower Tab
Replace ** with a color number	

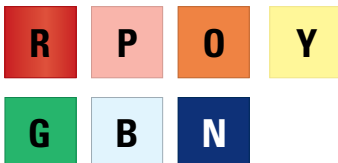

### In-Sight Outguides™

Outguides distinguish records or films that have not been returned. Print the out-of-file location of loaned items on the request slips and insert them into pockets for quick reference.

- Request slip pocket size: 3-1/4" x 5-1/2" (2-XOG-R is 3" x 7-3/4").
- Made of heavy-duty vinyl.
- See-through matte-finish pockets made from non-yellowing vinyl and stress-cut for durability.
- Select from 7 distinctive stock colors for letter size (additional colors available upon request). X-ray available in red only.

### Standard Tab 9" High x 13 3/4"

MODEL NO.	DESCRIPTION
ISOG-*	Lower Tab

### Short Tab 9 1/8" High x 12 1/2"

MODEL NO.	DESCRIPTION
ISOG-*ST	Lower Tab

### X-ray Standard Tab 8 1/4" High x 19 1/2" (Red only)

MODEL NO.	DESCRIPTION
2-XOG-R	Lower Tab

Replace \* with desired color letter



**Contact GBS and create the  
filing solution to meet your needs today!**



A TAB Brand