

tab Express

File Folders / Folder Accessories / Labels / Indexes / Pockets / File Labeling Software

In **2025**, we combined these brands into a single **TAB** catalog.



Now in 2026

*We added these brands to the **TAB** family.*

Available online at shoptab.com, by calling customer service or through your TAB Sales Manager.



1.888.466.8228



Find your file folders, filing labels, pockets, and more at any of our shopping sites shoptab.com • shoptab.ca • shopjetersystems.com

Have you had a chance to order products from one of our e-commerce sites? You can place orders for the products your organization uses today – on a faster more streamlined platform.

Looking for AMES medical office filing supplies? Check out either shoptab.com or shoptab.ca to find your AMES products.

What you'll find when you order online:

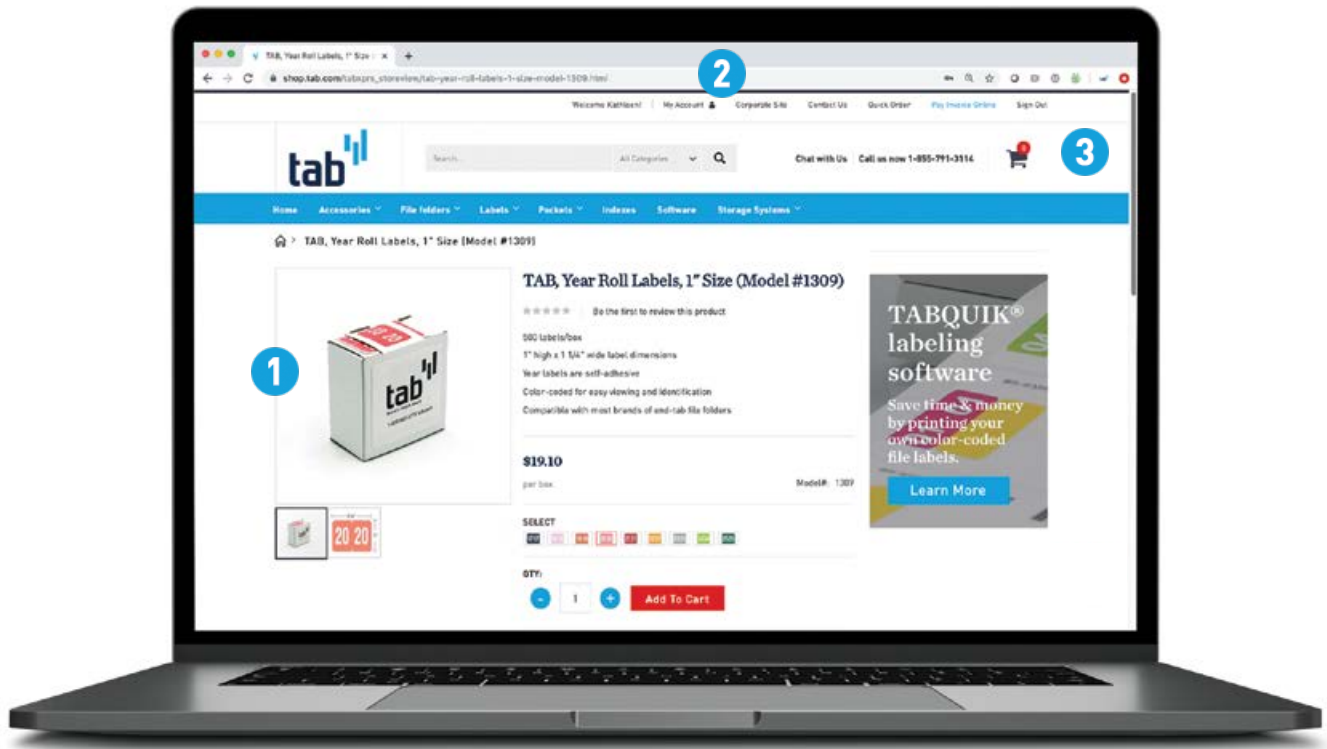

- 1 High-quality product photographs and detailed descriptions so you know exactly what you're getting
- 2 Self-service account management so you may update your address, account information and quickly re-order frequently used products
- 3 Streamlined 2-step order process with shipping and tax estimates available at time of checkout

Our sites provide a fast and easy shopping experience which will help you organize, access and store your physical files.

Visit
shoptab.com
•
shoptab.ca
•
shopjetersystems.com
to create an account today!

Table of Contents

Folders

Manila	4-10
Color and Color Stripe	11-15
GBS KARDEX Compatible	16-18
Classification	19-20
Expansion	21-23
tabZEROfile	24
FORTIfile	25

Pockets

Manila	26-28
Color and Color Stripe	29
Expansion	30-32

Health Care

Pockets	33
X-Ray Jackets	33-34
X-Ray Inserts	35
File Folders	36
VNA Folders	36
Dividers	37
Credential Files	38

Indexes

Health Care Title Sets	38
Index Labels.....	40
Custom Indexes & Filebacks	40-41
Stock Dividers & Filebacks	27-28

Folder Accessories

Fasteners.....	42-43
Vinyl Pockets.....	44
Dividers	45-46
Tabs.....	47
Repair and Reinforcement	48
Storage.....	48

Custom File Folder Options

Conversion Tabs	49
Manila Pockets	49
Strip Labels	50
Printing	50

Outguides

Vinyl.....	51
File Dividers.....	51
Charge-Out.....	52
Center and Bottom-Tab.....	52

TABQUIK

Labels	53
GBS NetLabels	53

Labels

Net Labels	53
Alphabetic.....	54-59
Numeric.....	60-65
Solid Color	66-67
Name	68
Medical.....	69
Custom.....	70
Month/Year.....	71-76
Accessories.....	77

Retired Items

Folders and Labels.....	78-82
-------------------------	-------

Terms & Policies	83
-----------------------------------	----

Index	84-86
--------------------	-------

Easy Order Planner	87
---------------------------------	----

TABQUIK®

Save time and money by printing your own color-coded file labels.



TABQUIK is easy.

Print labels in three simple steps: select the design, enter or import your data, and click "print".

TABQUIK is flexible.

It runs on any internet-connected computer with any popular browser and a standard color office printer.

TABQUIK is secure.

Sensitive data never leaves your computer.

To learn more call **888-466-8228**
or visit tabquik.com

Manila Folders – Side/End Tab

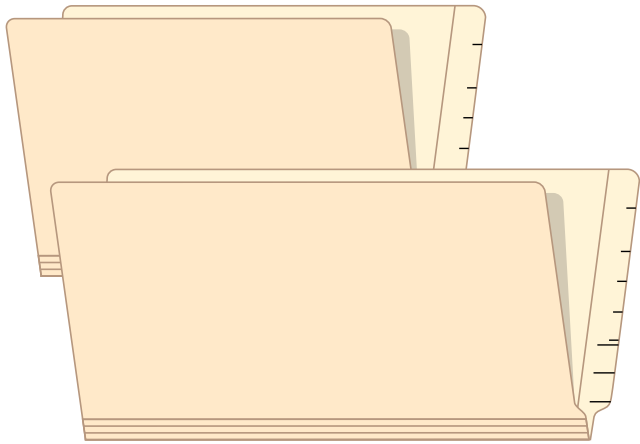

TAB Standard Folders

TAB's standard folders are designed to provide an inch of space in both paper dimensions insuring that your important documents are protected from wear and tear in file or out. The double-ply side tab provides extra strength where other folders often break down.



Letter – Standard 9½" W x 11¾" H

MODEL	DESCRIPTION	QUANTITY
1103-50	11 pt. Double Ply	box of 100
1123-00	14 pt. Double Ply	box of 50
1102-00	11 pt. Single Ply	box of 100
1128-00	14 pt. Single Ply	box of 50
1141-00	18 pt. Single Ply	box of 50

Legal – Standard 9½" W x 14¾" H

MODEL	DESCRIPTION	QUANTITY
1105-50	11 pt. Double Ply	box of 100
1127-00	14 pt. Double Ply	box of 50
1104-00	11 pt. Single Ply	box of 100
1118-00	14 pt. Single Ply	box of 50
1142-00	18 pt. Single Ply	box of 50

TAB Non-Reinforced Standard Folders

Durable, yet inexpensive non-reinforced folders are available with 2" bonded fasteners in positions #1 and #3.

MODEL NO.	DESCRIPTION	LBS./BOX	QUANTITY
PMFLD	with fasteners	49 lbs.	box of 250

To Order Custom Imprint Call 1.888.466.8228.

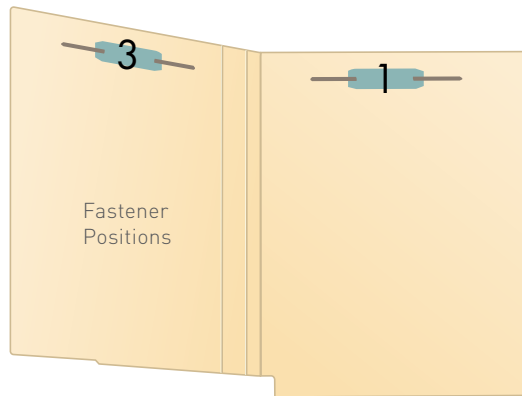

- Size: 9-1/2" x 12-1/4".
- Made of sturdy 11 point manila stock.
- Side and top tabs

TAB Short Body Folders

Need to store your folders in a drawer as well as on a shelf? Our short body folder (Length reduced by 1/4") has a space provided on the top back panel to attach a label for quick identification.

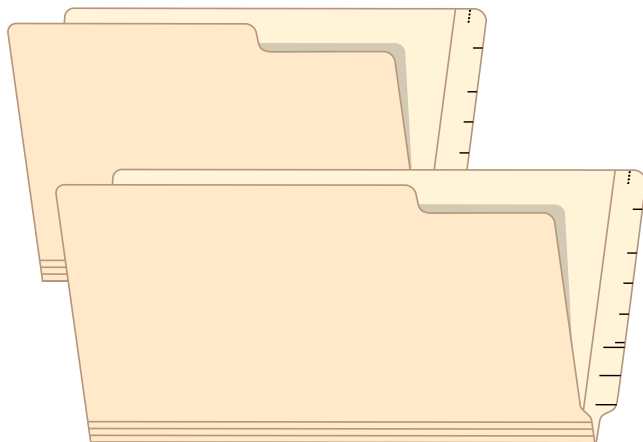

Letter – Short Body 9½" W x 11½" H

MODEL NO.	DESCRIPTION	QUANTITY
1317-00	11 pt. Double Ply	box of 100
1318-00	14 pt. Double Ply	box of 50

Legal – Short Body 9½" W x 14½" H

MODEL NO.	DESCRIPTION	QUANTITY
1327-00	11 pt. Double Ply	box of 100
1328-00	14 pt. Double Ply	box of 50

Manila Folders – Side/End Tab

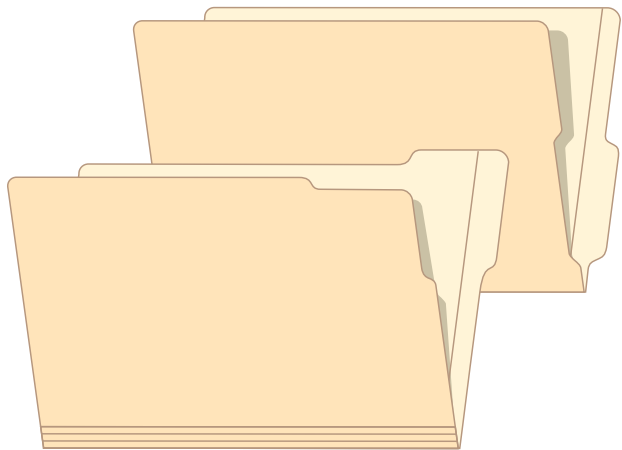

TAB Half Cut (Lower/Upper) Manila Folders

Letter size 11 pt. manila double-ply folder with 4" side tab. Ideal application for numbering on tab.



Letter

MODEL NO.	DESCRIPTION	QUANTITY
4354-50	Lower position tab	box of 100
4357-13	Upper position tab	box of 100

TAB Kraft Side Tab Folder

Letter

MODEL NO.	DESCRIPTION	QUANTITY
1129-00	17 pt. Single Ply	box of 50

Legal

MODEL NO.	DESCRIPTION	QUANTITY
1119-00	17 pt. Single Ply	box of 50

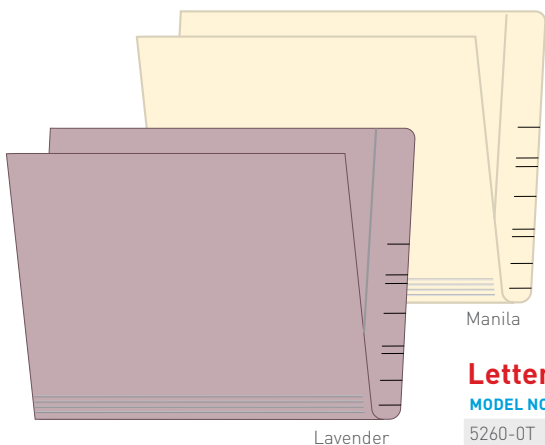

TAB Manila and Lavender – Double Side Tab Folders

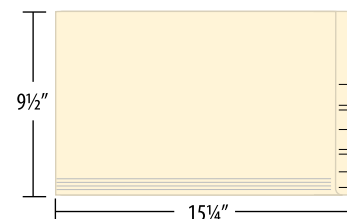
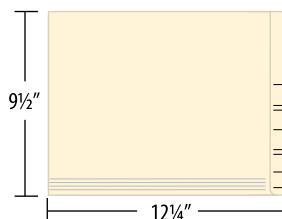

Letter

MODEL NO.	DESCRIPTION	QUANTITY
5260-0T	14pt Lavender, Eternafilm reinforced	box of 50
5050-0T	11pt Lavender	box of 50
5050-00	11pt Manila	box of 50
5150-00	14pt Manila	box of 50

Legal

MODEL NO.	DESCRIPTION	QUANTITY
5100-0T	11pt Lavender	box of 50
5100-00	11pt Manila	box of 50

Manila Folders – Side/End Tab

TAB Side-Reinforced Folders

Affordable side-reinforced manila folders available in 11 or 15 point stock.

- Overall size: 9-1/2" x 12-3/16".
- 2-1/16" reinforced side tab.
- Folders are scored above the fold for self expansion.

MODEL NO.	DESCRIPTION	LBS./BOX	QUANTITY
LI-FLD11	11 pt. folder	45 lbs.	box of 500
LI-FLD15	15 pt. folder	30 lbs.	box of 250

Custom Imprint Available.



To Order Custom Imprint Call 1.888.466.8228.

TAB Easiclip Folders

Easiclip folders give you the same accessibility as 3-ring binders, while saving you more shelf space.

- Overall size: 9-1/2" x 12-1/8", including a 3/4" side tab.
- Choose 11 point or 15 point manila stock.
- Folders are scored above the fold for self expansion.
- Easiclips come factory-attached to the folders in position 5 (shown right).

MODEL NO.	DESCRIPTION	LBS./BOX	QUANTITY
OCFV-EZ	11 point	28 lbs.	250/carton
OCFV-EZ-15	15 point	38 lbs.	250/carton

Custom Imprint Available.

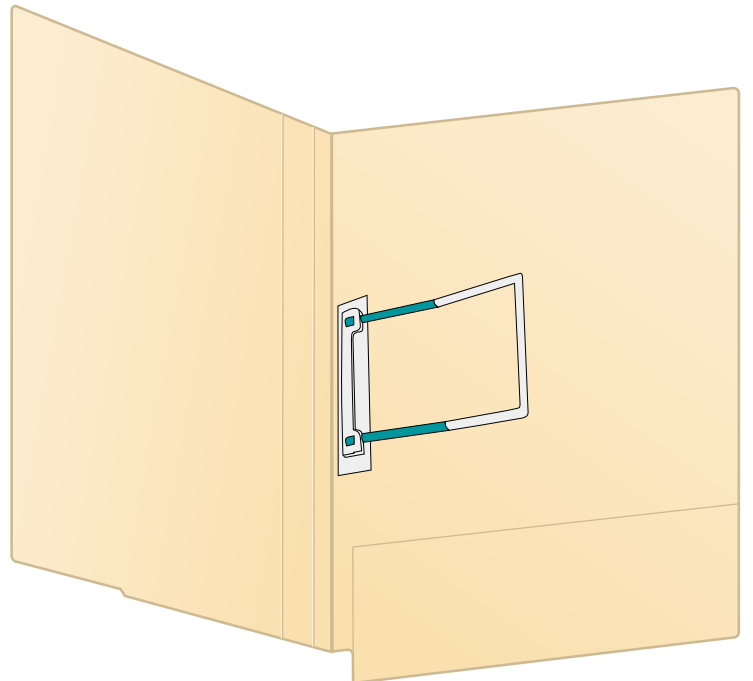

Manila Folders – Side/End Tab

Jeter Super Coded File Folders

Super Coder folders have a full-length end tab designed with a variety of label placement fields. All Super Coders come with our trademarked label alignment marks. These alignment marks are unique and make it easy to place labels in the correct position time after time. Super Coder File Folders are available in both letter and legal sizes.

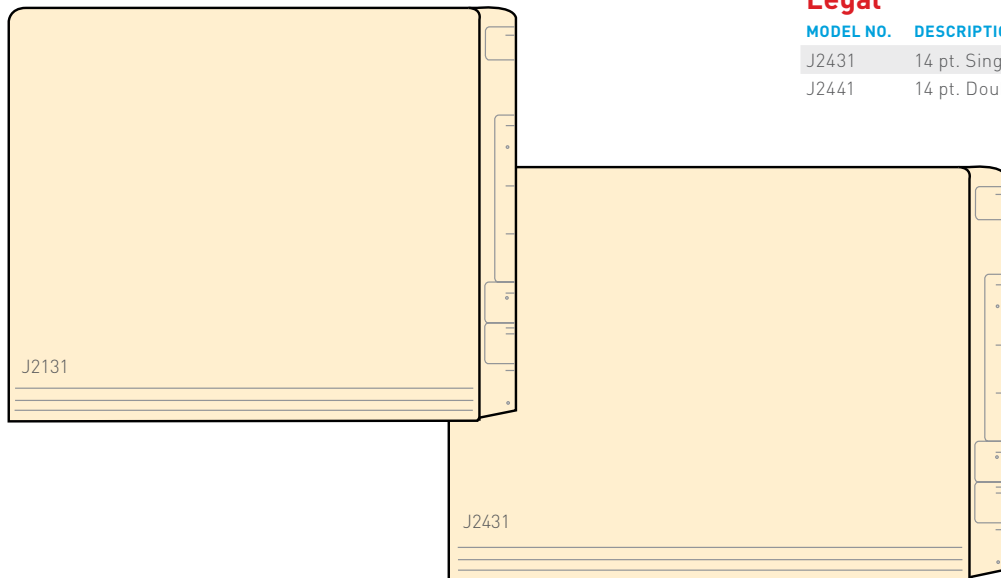

Letter

MODEL NO.	DESCRIPTION	BOX/CARTON
J2131	11 pt. Single Ply	100/500
J2231	14 pt. Single Ply	100/500
J2141	11 pt. Double Ply	100/400
J2241	14 pt. Double Ply	100/400

Legal

MODEL NO.	DESCRIPTION	BOX/CARTON
J2431	14 pt. Single Ply	50/250
J2441	14 pt. Double Ply	50/250

Jeter Mini Compact Filing Supplies

Mini size folders are an optimum way to contain smaller than letter size records. They have become standard throughout the optical industry, used by nationally recognized chains. If only a few letter size documents accumulate within your folders, mini size file folders could be used to save an enormous amount of space. Simply fold the documents in half. Jeter manufactures a complete line of mini size filing equipment and color-coding labels to complement our mini file folders.

MODEL NO.	DESCRIPTION	BOX/CARTON
9-1/2" W x 6" H	J13069 9" W x 6" H	
J1569*	11 pt. Single Ply	100/500
J2269**	11 pt. Single Ply	100/500
J13069***	11 pt. Single Ply	50/250

*Mini half pocket **Mini half folder ***Mini top-loading pocket

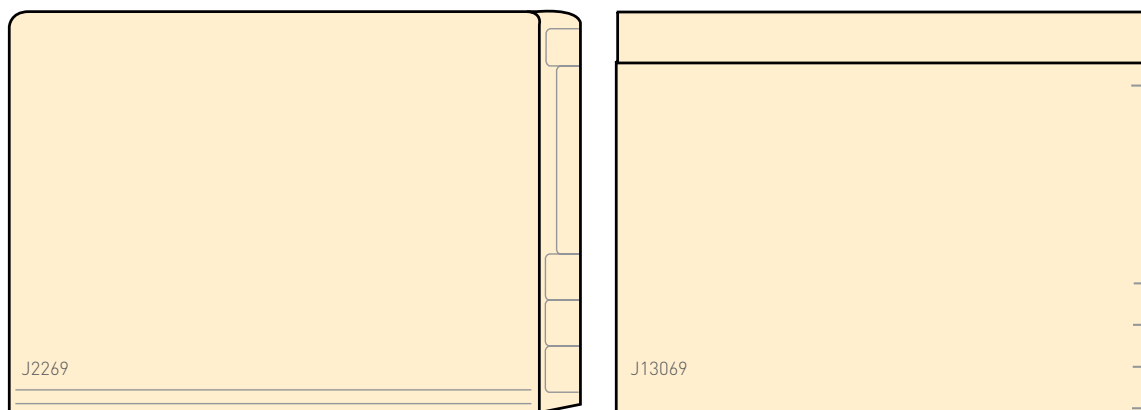

Manila Folders – Side/End Tab

AMES DuraTab Reinforced Folders

AMES 11 point and 14 point manila folders come with DuraTab interlocking double reinforced top and side tabs that stand up to frequent use.

- Side tab folders are designed for open shelf filing and feature outline blocks on the tabs for optional color-coded tapes.
- Folders are scored above the fold for self expansion.

Self-Expansion Manila Folders

MODEL NO.	DESCRIPTION	SIZE	LBS./BOX	QUANTITY
OCFV-A	11 pt., side tab	9-1/2" x 12-1/8"	46 lbs.	box of 500
OCFV-A15	14 pt., side tab	9-1/2" x 12-1/8"	32 lbs.	box of 250

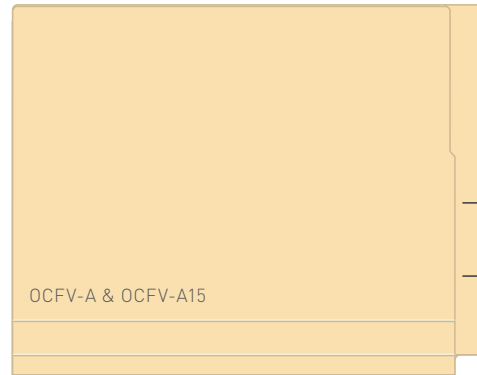

To Order Custom Imprint Call 1.888.822.9777.

AMES Standard Reinforced Folders with Fasteners

AMES standard manila folders with fasteners come with DuraTab interlocking double reinforced top and side tabs for added durability and strength.

- Overall size: 9-1/2" x 12-1/8".
- Available in 11 point manila stock.
- Choose one or two 2" bonded fasteners.
- Folders are scored above the fold for self expansion.

MODEL NO.	DESCRIPTION	SIZE	LBS./BOX	QUANTITY
OCFV-1P	11 pt., 1 fastener	9-1/2" x 12-1/8"	50 lbs.	box of 250
OCFV-2P	11 pt., 2 fasteners	9-1/2" x 12-1/8"	52 lbs.	box of 250

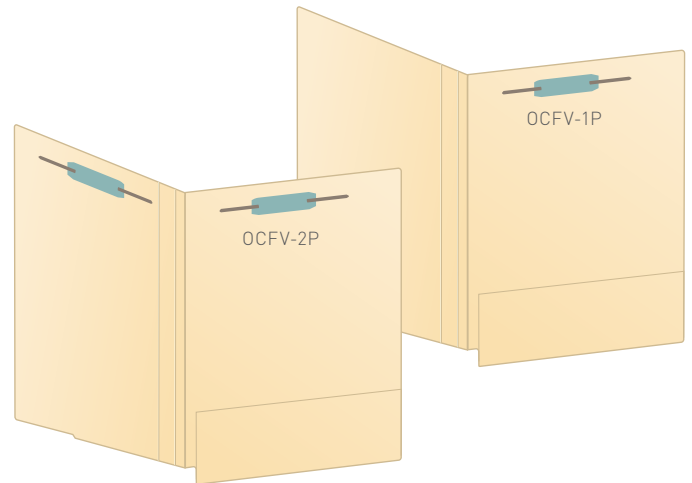

GBS Manila Folder 12 1/4" W x 9 1/2" H

Letter

MODEL NO.	DESCRIPTION	QTY	CARTON WT.
9185	14 Pt. Letter Size • Single Ply Tab	80 box/400 carton	45 Lbs.
9187	11 Pt. Letter Size • Reinforced Tab	50 box/250 carton	34 Lbs.
9188	14 Pt. Letter Size • Reinforced Tab	50 box/250 carton	32 Lbs.

GBS Reinforced File Folder 12" W x 9-1/2" H with 9" Front

Letter

MODEL NO.	DESCRIPTION	QTY	CARTON WT.
8662	14 pt., Reinforced Top & Side, Dual Tab Folder, Works for Drawer and Shelf	25 box/250 carton	31 Lbs.

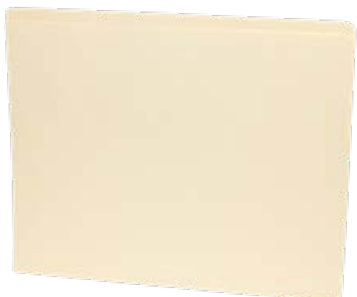

GBS Drawer File Folder 11 3/4" W x 9-1/2" H

Letter

MODEL NO.	DESCRIPTION	QTY	CARTON WT.
8663-1	11 pt., Full Cut Tab, 9" Front, 9" Tick-Marks	100 box/500 carton	40 Lbs.
8665-1	14 pt., Full Cut Tab, 9" Front, 9" Tick-Marks	100 box/500 carton	44 Lbs.



Manila Folders – Top Tab

TAB Top Tab Manila Folders

Letter

MODEL NO.	DESCRIPTION	QUANTITY
1112-00	11 pt Double Ply	box of 100
1111-00	14 pt Single Ply	box of 100

Legal

MODEL NO.	DESCRIPTION	QUANTITY
1122-00	11 pt Double Ply	box of 50
1114-00	14 pt Single Ply	box of 50



TAB 3 Position Top Tab Manila Folders

Letter (87/8" high front; 9 1/2" high back x 11 3/4" wide)

MODEL NO.	DESCRIPTION	QUANTITY
1157-00	11 pt Single Ply Positions 123 collated	box of 100
1157-L	11 pt Single Ply Left Tab	box of 100
1157-R	11 pt Single Ply Right Tab	box of 100
1157-C	11 pt Single Ply Center Tab	box of 100

Legal (87/8" high front; 9 1/2" high back x 14 3/4" wide)

MODEL NO.	DESCRIPTION	QUANTITY
1158-00	11 pt Single Ply Positions 123 collated	box of 100
1158-L	11 pt Single Ply Left Tab	box of 100
1158-R	11 pt Single Ply Right Tab	box of 100
1158-C	11 pt Single Ply Center Tab	box of 100

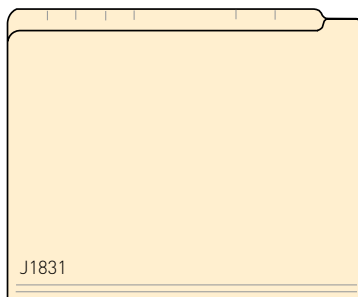

Jeter Top Tab File Folders

Jeter has designed a line of top tab file folders made of heavy grade, 14-point manila stock. These systems work well in drawer files and/or in lateral roll-out systems. Our top tab file folders are taller for improved visibility. Label alignment marks are preprinted at the factory, so you know exactly where to put the appropriate color-code. Use our top tab folders with our Top Coder color-coding system. File folders are available from stock with fasteners in common positions.

Letter 11-3/4" W x 9-5/8" H

MODEL NO.	DESCRIPTION	BOX/CARTON	WT/CARTON
J1831	14 pt. Single Ply	100/500	49

Legal 14-3/4" W x 9-5/8" H

MODEL NO.	DESCRIPTION	BOX/CARTON	WT/CARTON
J1931	14 pt. Single Ply	50/250	31

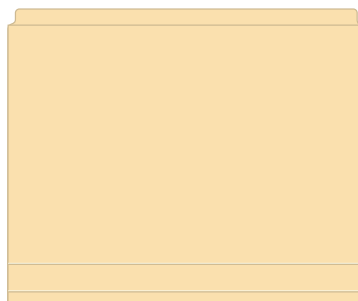

AMES 1/2" Drop Front Folder

COCFV folders designed for drawer filing.

MODEL NO.	DESCRIPTION	SIZE	LBS./BOX	QUANTITY
COCFV	11 pt., 1/2" drop front	9-1/2" x 11-3/4"	46 lbs.	box of 500

To Order Custom Imprint Call 1.888.466.8228.

Manila Folders – Top Tab/End Tab

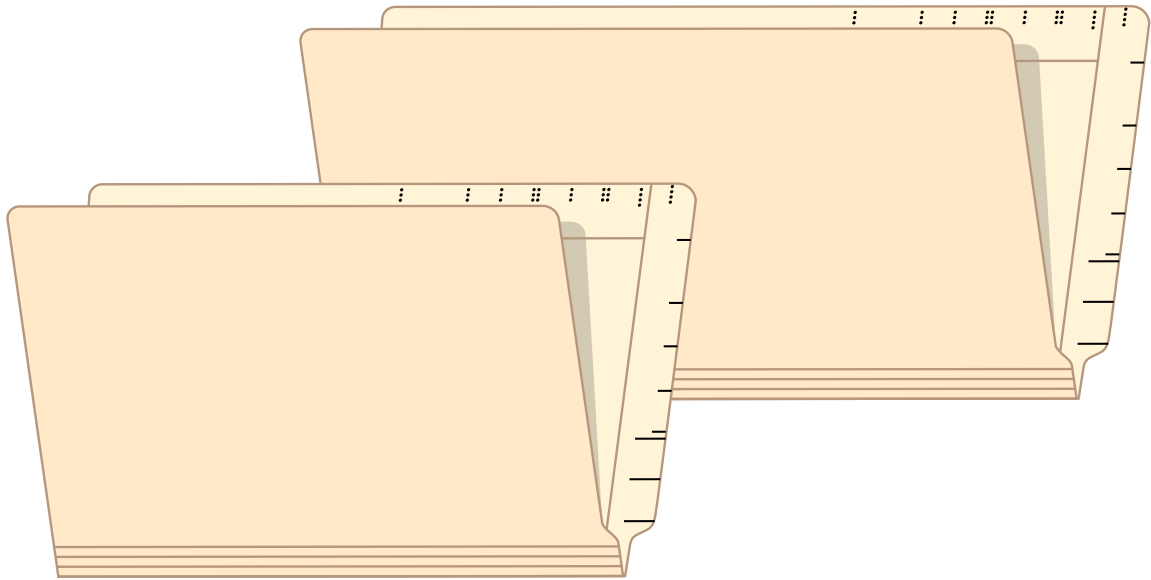

2TAB Folders

Full length top and side tabs allow for color coding labels to be applied in both locations. And with its reduced length (1/4") it fits safely into a drawer or a shelf.



Letter – 2TAB

MODEL NO.	DESCRIPTION	QUANTITY
1344-00	11 pt. 2TAB	box of 100
1345-00	14 pt. 2TAB	box of 50



Legal – 2TAB

MODEL NO.	DESCRIPTION	QUANTITY
1346-00	11 pt. 2TAB	box of 50
1347-00	14 pt. 2TAB	box of 50

11 pt. is double-ply top and side tabs. 14 pt. is single-ply top tab and double-ply side tab.

jeter Drop Front Super Coder

All the features of the Super Coder 14-point folder in a design with a shorter front flap, so the inside back cover of the folder is exposed. Similar to the standard top/end tab folder, this design allows use of the folder's top edge for indexing or notes.

Letter 12-1/4" W x 9-1/2" H with 9" Front Flap

MODEL NO.	DESCRIPTION	BOX/CARTON	WT/CARTON
J2232	14 pt. Single Ply	100/500	49

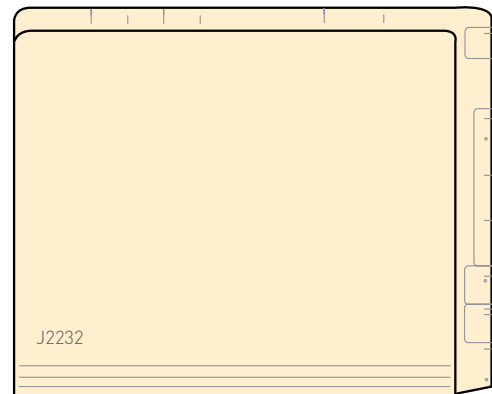

Folders – Color and Color Stripe

TAB Standard Solid Color Side Tab Folders



Letter

MODEL NO.	DESCRIPTION	QUANTITY
1106-**	11 pt. Standard	box of 100
1406-**	14 pt. Standard	box of 50

Legal

MODEL NO.	DESCRIPTION	QUANTITY
1126-**	11 pt. Standard	box of 100
1426-**	14 pt. Standard	box of 50

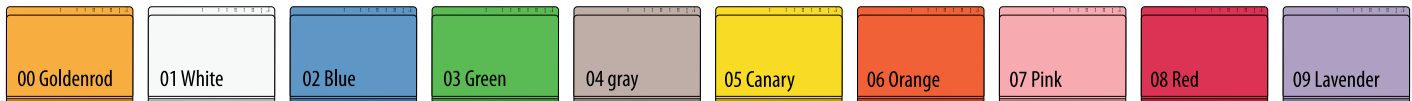

**Choose appropriate color suffix.

TAB Top Tab Solid Color Folders



Letter

MODEL NO.	DESCRIPTION	QUANTITY
1212-**	11 pt Double Ply Solid Color	box of 100
1222-**	14 pt Single Ply Solid Color	box of 100

Legal

MODEL NO.	DESCRIPTION	QUANTITY
1211-**	11 pt Double Ply Solid Color	box of 100
1214-**	14 pt Single Ply Solid Color	box of 50

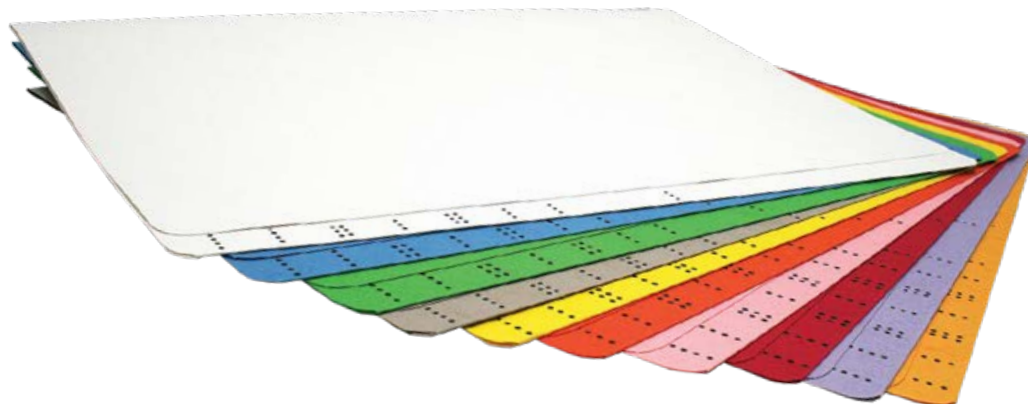

Folders – Color and Color Stripe

TAB Type II Top Tab Pressboard and Classification Folders

Letter (87/8" high front; 9 1/2" high back x 11 3/8" wide)

MODEL NO.	DESCRIPTION	BOX/QTY
1255-00	25 pt Green/Grey 2" Expansion	box of 25
1255-**	25 pt Color 2" Expansion	box of 25

Letter (87/8" high front; 9 1/2" high back x 11 3/8" wide)

MODEL NO.	DESCRIPTION	BOX/QTY
1254-00B	25 pt Green/Grey 1 Divider	box of 25
1254-**B	25 pt Color 1 Divider	box of 25
1454-00B	25 pt Green/Grey 2 Dividers	box of 25
1454-**B	25 pt Color 2 Dividers	box of 25

Legal (87/8" high front; 9 1/2" high back x 14 3/8" wide)

MODEL NO.	DESCRIPTION	BOX/QTY
1257-00	25 pt Green/Grey 2" Expansion	box of 25
1257-**	25 pt Color 2" Expansion	box of 25

Legal (87/8" high front; 9 1/2" high back x 14 3/8" wide)

MODEL NO.	DESCRIPTION	BOX/QTY
1256-00B	25 pt Green/Grey 1 Divider	box of 25
1256-**B	25 pt Color 1 Divider	box of 25
1456-00B	25 pt Green/Grey 2 Dividers	box of 25
1456-**B	25 pt Color 2 Dividers	box of 25

TAB Green/Grey and Color Folders w/Dividers

All folders with 1 & 2 dividers have 2" expansion. Fasteners included on classification folders, in positions 1 & 3, and on dividers.



Replace ** with a color number.
All color pressboard folders may require up to a 35-day lead time.

TAB 25 pt. Type II Color Pressboard

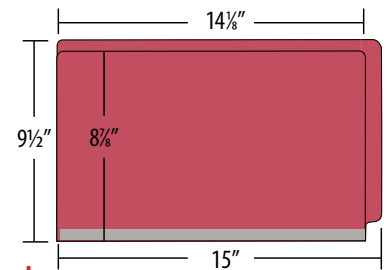
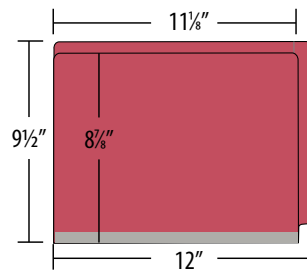

Letter

MODEL NO.	DESCRIPTION	QUANTITY
1235-**	1" Expansion Standard	box of 25
1236-**	2" Expansion Standard	box of 25
1348-**	1" Expansion 2TAB	box of 25
1349-**	2" Expansion 2TAB	box of 25

Legal

MODEL NO.	DESCRIPTION	QUANTITY
1250-**	1" Expansion Standard	box of 25
1251-**	2" Expansion Standard	box of 25
1350-**	1" Expansion 2TAB	box of 25
1351-**	2" Expansion 2TAB	box of 25

TAB 25 pt. Type II Color Pressboard Expansion with Dividers

All folders with 1 & 2 dividers have 2" expansion.
All folders with 3 dividers have 3" expansion. Fasteners included on folder and dividers.



Letter

MODEL NO.	DESCRIPTION	QUANTITY
1244-**B	Standard w/1 divider	box of 25
1245-**B	Standard w/2 dividers	box of 25
1243-**B	Standard w/3 dividers	box of 25
1352-**B	2TAB w/1 divider	box of 25
1353-**B	2TAB w/2 dividers	box of 25



Legal

MODEL NO.	DESCRIPTION	QUANTITY
1246-**B	Standard w/1 divider	box of 25
1247-**B	Standard w/2 dividers	box of 25
1248-**B	Standard w/3 dividers	box of 25
1354-**B	2TAB w/1 divider	box of 25
1355-**B	2TAB w/2 dividers	box of 25

Folders – Color and Color Stripe

Jeter Color Super Coders

Jeter makes Super Coders in five bright, distinctive colors: blue, green, red, white and yellow. These are the highest quality colored folders available. They feature paper much stronger than the normal dyed papers used by most folder makers, plus a super reinforced tab. Coloration is very even and consistent. These folders are printed with our unique label alignment marks for simple color coding.

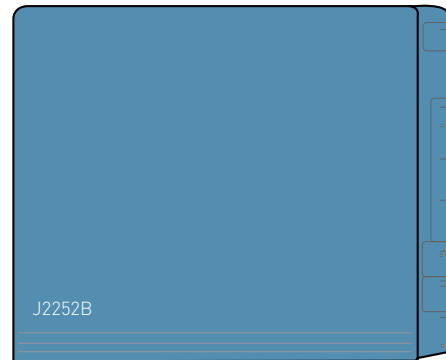

Letter 12-1/4" W x 9-1/2" H, 11 pt., Double Ply

MODEL NO.	COLOR	FASTENER POSITION	BOX/CARTON	CARTON WT.	MODEL NO.	COLOR	FASTENER POSITION	BOX/CARTON	CARTON WT.
J2252B	Blue	N/A	100/500	45 Lbs.	J2252R-56	Red	1	50/250	28 Lbs.
J2252B-56	Blue	1	50/250	28 Lbs.	J2252R-58	Red	1+3	50/250	30 Lbs.
J2252B-58	Blue	1+3	50/250	30 Lbs.	J2252W	White	N/A	100/500	45 Lbs.
J2252G	Green	N/A	100/500	45 Lbs.	J2252W-58	White	1+3	50/250	30 Lbs.
J2252G-58	Green	1+3	50/250	30 Lbs.	J2252Y	Yellow	N/A	100/500	45 Lbs.
J2252R	Red	N/A	100/500	45 Lbs.	J2252Y-58	Yellow	1+3	50/250	30 Lbs.



GBS Color Stock Folders 12 1/4" W x 9-1/2" H

Letter

MODEL NO.	DESCRIPTION	CARTON QTY	CARTON WT.
8661	11 pt., Reinforced End Tab	350	34 Lbs.

COLORS: Light Blue, Brown, Pink, Purple, Tan, Green, Orange, Red, Yellow, White, Gray, and Dark Blue

Folders – Color and Color Stripe

Add Color to Your World With TAB Color Stripe Folders

Separate yourself from the crowd by using color to identify your files.

TAB Manila Color Stripe Folders



Letter

MODEL NO.	DESCRIPTION	QUANTITY
1162-**	11 pt. Standard	box of 100

Legal

MODEL NO.	DESCRIPTION	QUANTITY
1163-**	11 pt. Standard	box of 100

**Choose appropriate color suffix.

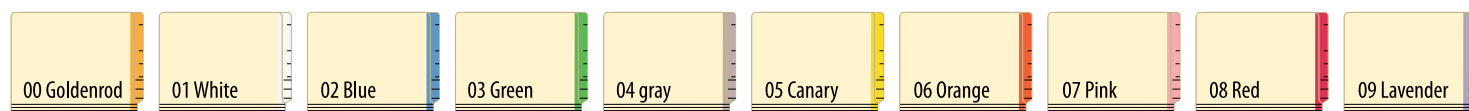

TAB White Folders with Color Side Tabs

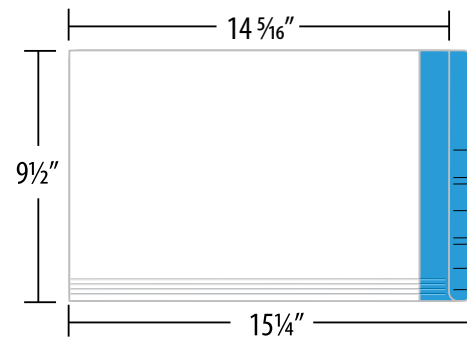
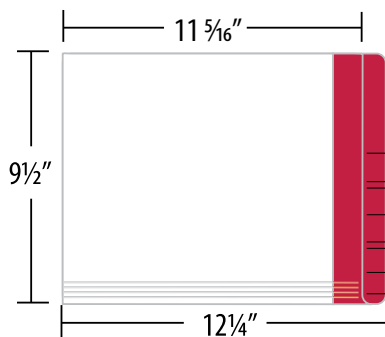

Letter

MODEL NO.	DESCRIPTION	QUANTITY
CN1219-*	14pt Eternafilm reinforced	box of 225
CN1259-*	14pt Eternafilm reinforced Long letter: 9 1/2 x 12 1/2 x 13 overall	box of 225

Legal

MODEL NO.	DESCRIPTION	QUANTITY
CN1229-*	14pt Eternafilm reinforced	box of 225

**Choose appropriate color suffix.



Folders – Color and Color Stripe

jeter Color Stripe Super Coders

Color Stripe Super Coder folders are used to color-code different classes, groups or years. Available in blue, green, red and yellow color stripes. Stronger than any colored stock folder, they are super reinforced with a full 1-1/2" of 14-point manila paper folded over and glued for added strength and rigidity. Color stripes are 1-3/4" deep.

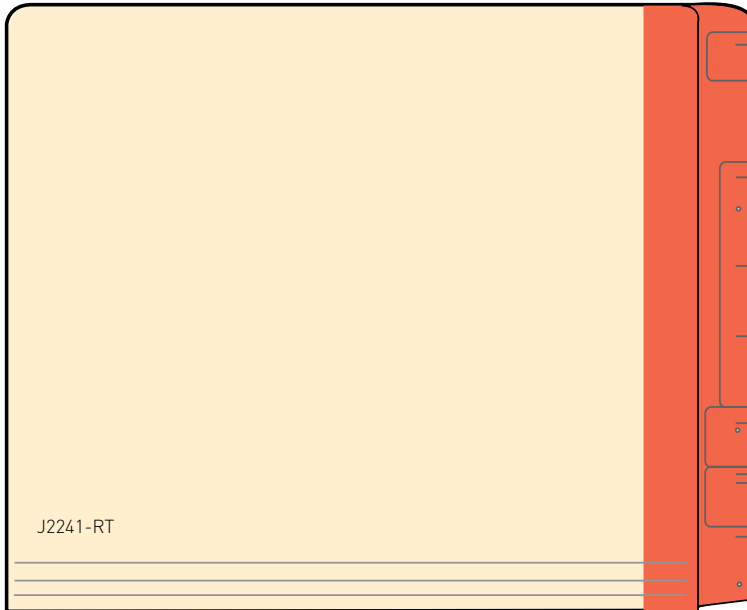

Letter 12-1/4" W x 9-1/2" H, 14 pt., Double Ply

MODEL NO.	STRIPE COLOR	FASTENER POSITION	QTY	CARTON WT.
J2241-BT	Blue	N/A	100/400	44 Lbs.
J2241-BT-56	Blue	1	50/250	31 Lbs.
J2241-BT-58	Blue	1+3	50/250	33 Lbs.
J2241-GT	Green	N/A	100/400	44 Lbs.
J2241-GT-56	Green	1	50/250	31 Lbs.
J2241-GT-58	Green	1+3	50/250	33 Lbs.
J2241-RT	Red	N/A	100/400	44 Lbs.
J2241-RT-56	Red	1	50/250	31 Lbs.
J2241-RT-58	Red	1+3	50/250	33 Lbs.
J2241-YT	Yellow	N/A	100/400	44 Lbs.
J2241-YT-56	Yellow	1	50/250	31 Lbs.
J2241-YT-58	Yellow	1+3	50/250	33 Lbs.

GBS Color Banded End Tab Folders

Color end tab folders enable you to color-code different groups of documents for easy retrieval of your most important files. Available in Black, Light Blue, Dark Blue, Brown, Gray, Light Green, Dark Green, Orange, White, Yellow, Pink, Purple, and Red. With a reinforced color stripe side tab.

Letter 12-1/4" W x 9-1/2" H

MODEL NO.	DESCRIPTION	QTY	CARTON WT.
8687C	11 Pt., Reinforced Tab	box 100/carton 500	34 Lbs.

COLORS: Black, Light Blue, Dark Blue, Brown, Gray, Light Green, Dark Green, Orange, White, Yellow, Pink, Purple, and Red



Folders – GBS KARDEX Compatible

Create an organizational mosaic with reinforced top tab and two tab GBS Kardex compatible full color folders.

Quickly identify your files by using bold colors.

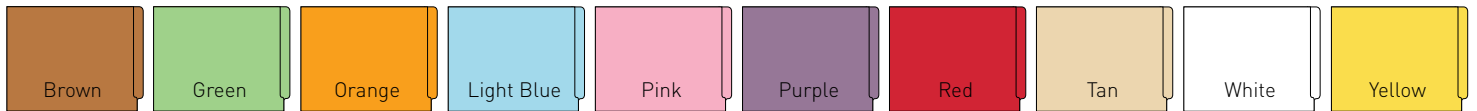

GBS Kardex Letter Size

GBS Kardex Compatible 11 point color file folders come with reinforced top tab or two tab and a variety of colors.

COLORS: Brown, Green, Orange, Light Blue, Pink, Purple, Red, Tan, White & Yellow

Letter Size Color Stock, 11 Pt.

MODEL NO.	DESCRIPTION	QTY	CARTON WT.
A KA-5099R	Kardex Straight Edge Reinforced, 9" Front Flap, 11¼" W x 9½" H	100/500	45 Lbs.
B KA-50998R	Kardex Top Tab Reinforced, 9½" Front Flap, 11¼" W x 10" H, Tab 2/5 ROC	100/500	45 Lbs.
C KA-2610002	Kardex TCUCP®, Top & Side Tab, 9" Front Flap, 11¼" W x 9½" H, 0-9 Scale	100/500	45 Lbs.
D KA-2610003R	Kardex Colorscan®, Top & Side Tab, 9" Front Flap, A-Z scale left Back Flap only 11¼" W x 9½" H	100/500	45 Lbs.
E KA-2610004R	Kardex Right End Tab, Right Tab Printed with Tick Marks, 12¼" W x 9½" H	100/500	45 Lbs.
F KA-2610005R	Kardex Left End Tab, Left Tab Printed with Tick Marks, 12¼" W x 9½" H	100/500	45 Lbs.



Folders – GBS KARDEX Compatible

GBS Kardex Compatible Letter Size Expansion Folder

GBS Kardex Compatible 11 point color file folders come with reinforced top tab or two tab and a variety of colors.

COLORS: Light Blue, Brown, Green, Tan, White, Orange, Purple, Red, Pink & Yellow

Letter Size Color Stock, 20 Pt., 9" Front

MODEL NO.	DESCRIPTION	CARTON QTY	CARTON WT.
A KA-2510003	Kardex Colorscan®, Printed Back Flap A-Z Scale, 11 $\frac{3}{4}$ " W x 9 $\frac{1}{2}$ " H, 2" Expansion	250	39 Lbs.
B KA-2510004	Kardex, Right Tab with Printed Tick Marks, 12 $\frac{1}{4}$ " W x 9 $\frac{1}{2}$ " H, 2" Expansion	250	39 Lbs.
C KA-2510005	Kardex, Left Tab with Printed Tick Marks, 12 $\frac{1}{4}$ " W x 9 $\frac{1}{2}$ " H, 2" Expansion	250	39 Lbs.
D KA-2510004/3/2Scored	Kardex Scored Folded, Letter Size, 9" Front, 12 $\frac{1}{4}$ " W x 9 $\frac{1}{2}$ " H	250	39 Lbs.



GBS Kardex Compatible Legal Size Expansion Folder

GBS Kardex Compatible expansion color folders come in 20 point and allow you to store more of your documents in a single folder.

COLORS: Light Blue, Brown, Green, Tan, White, Orange, Purple, Red, Pink & Yellow

Legal Size Color Stock, 20 Pt., 9" Front

MODEL NO.	DESCRIPTION	CARTON QTY	CARTON WT.
E KA-2520003	Kardex Colorscan®, 2" Expansion, A-Z Scale, 14 $\frac{7}{8}$ " W x 9 $\frac{1}{2}$ " H, 2" Expansion	250	50 Lbs.
F KA-2520004	Kardex End Tab, 2" Expansion, 15 $\frac{1}{4}$ " W x 9 $\frac{1}{2}$ " H, Right Tab with printed Tick Marks, 1 $\frac{1}{2}$ " Expansion	250	50 Lbs.
G KA-2520004/3/2S	Kardex End Tab, 15 $\frac{1}{4}$ " W x 9 $\frac{1}{2}$ " H, Right Tab with printed Tick Marks, Scored and folded for $\frac{3}{4}$ " Expansion	250	50 Lbs.



Folders – GBS KARDEX Compatible

GBS Kardex Compatible Top and Side Tab Folders

GBS Kardex compatible top and side tab folders give you more options on how to store your important documents.

COLORS: Light Blue, Brown, Green, Tan, White, Orange, Purple, Red, Pink & Yellow

Legal Size Color Stock, 11 Pt., 9" Front

MODEL NO.	DESCRIPTION	CARTON QTY	CARTON WT.
K KA-5299R	Kardex Straight Edge Reinforced, 14 ⁷ / ₈ " W x 9 ¹ / ₂ " H, 9" Front Flap	500	53 Lbs.
L KA-52998R	Kardex Top Tab Reinforced, 14 ⁷ / ₈ " W x 9 ¹ / ₂ " H, 9 ¹ / ₂ " Front Flap, Tab 2/5 ROC	500	53 Lbs.
M KA-2620004R	Kardex End Tab, Scored and folded for 3/4" Expansion, 15 ¹ / ₄ " W x 9 ¹ / ₂ " H, Right Tab with printed Tick Marks	500	53 Lbs.
N KA-2620003R	Kardex ColorsScan®, 9" Front Flap, 14 ⁷ / ₈ " W x 9 ¹ / ₂ " H, Printed A-Z Left Back Flap Only	500	53 Lbs.

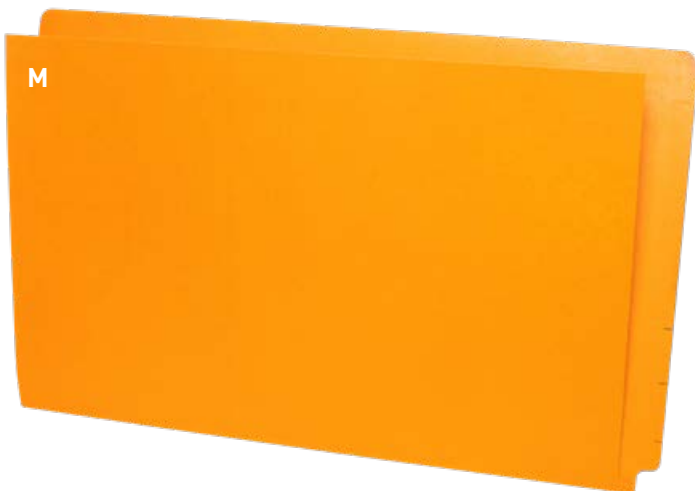

Folders – Classification

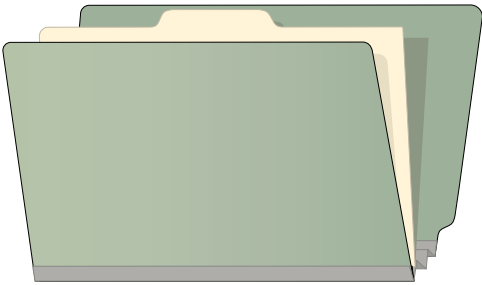

All folders with 1 & 2 dividers have 2" expansion.

All folders with 3 dividers have 3" expansion.

Fasteners included on folder and dividers.

TAB 25 pt. Type II – Standard Green/Gray Pressboard



Letter

MODEL NO.	DESCRIPTION	QUANTITY
1244-00B	Standard w/1 divider	box of 25
1245-00B	Standard w/2 dividers	box of 25
1243-00B	Standard w/3 dividers	box of 25



Legal

MODEL NO.	DESCRIPTION	QUANTITY
1246-00B	Standard w/1 divider	box of 25
1247-00B	Standard w/2 dividers	box of 25
1248-00B	Standard w/3 dividers	box of 25

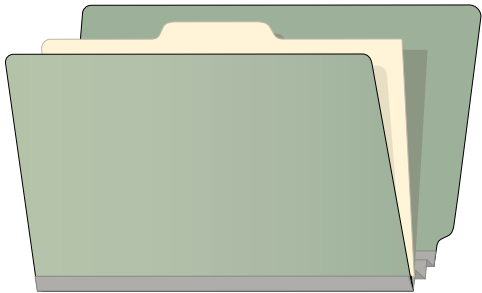

All folders with 1 & 2 dividers have 2" expansion.

Fasteners included on folder and dividers.

TAB 25 pt. Type II – 2TAB Green/Gray Pressboard

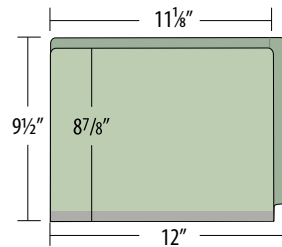

Letter

MODEL NO.	DESCRIPTION	QUANTITY
1352-00B	2TAB w/1 divider	box 25
1353-00B	2TAB w/2 dividers	box 25

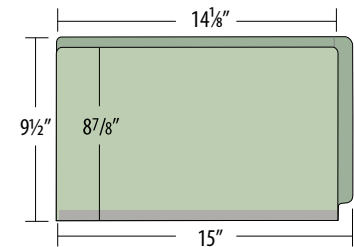

Legal

MODEL NO.	DESCRIPTION	QUANTITY
1354-00B	2TAB w/1 divider	box 25
1355-00B	2TAB w/2 dividers	box 25

Datafile® Pressboard Classification Folder with Full Side Tab

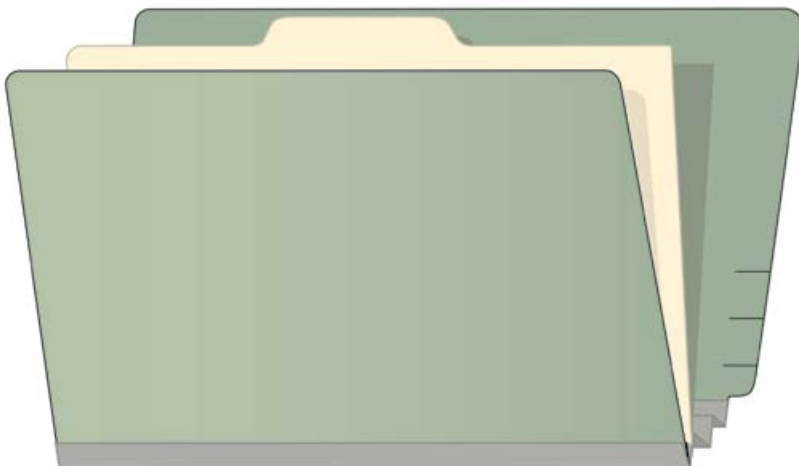

For use when segmentation of information is needed within a folder, such as mortgage or personnel data. These 25 pt. pressboard folders with manila dividers are available with 2" or 3" expansion. Fasteners are included in positions #1 and #3 of folder and positions #1 and #3 of each divider.

Letter

MODEL NO.	DESCRIPTION	QUANTITY
F101213	25 pt Letter, 1 divider, 2" exp	box of 50
F101313	25 pt Letter, 2 divider, 3" exp	box of 50

Legal

MODEL NO.	DESCRIPTION	QUANTITY
F102213	25 pt Legal, 1 divider, 2" exp	box of 50
F102313	25 pt Legal, 2 divider, 3" exp	box of 50

Folders – Classification

TAB Classification Folder – 1 & 2 Dividers

Allows documents to be subdivided within the folder into as many as six categories. These sturdy 18 pt. manila folders expand up to 1-1/2" and have 2" bonded fasteners in positions 1 and 3 of the folder. Each divider has twin prong fastener included.

Letter

MODEL NO.	DESCRIPTION	QUANTITY
1258-00B	9 1/2" x 11 3/4" - 12 1/4" - 1 divider	box of 25
1268-00B	9 1/2" x 11 3/4" - 12 1/4" - 2 dividers	box of 25

Legal

MODEL NO.	DESCRIPTION	QUANTITY
1259-00B	1 1/2" x 14 3/4" - 15 1/4" - 1 divider	box of 25
1269-00B	1 1/2" x 14 3/4" - 15 1/4" - 2 dividers	box of 25

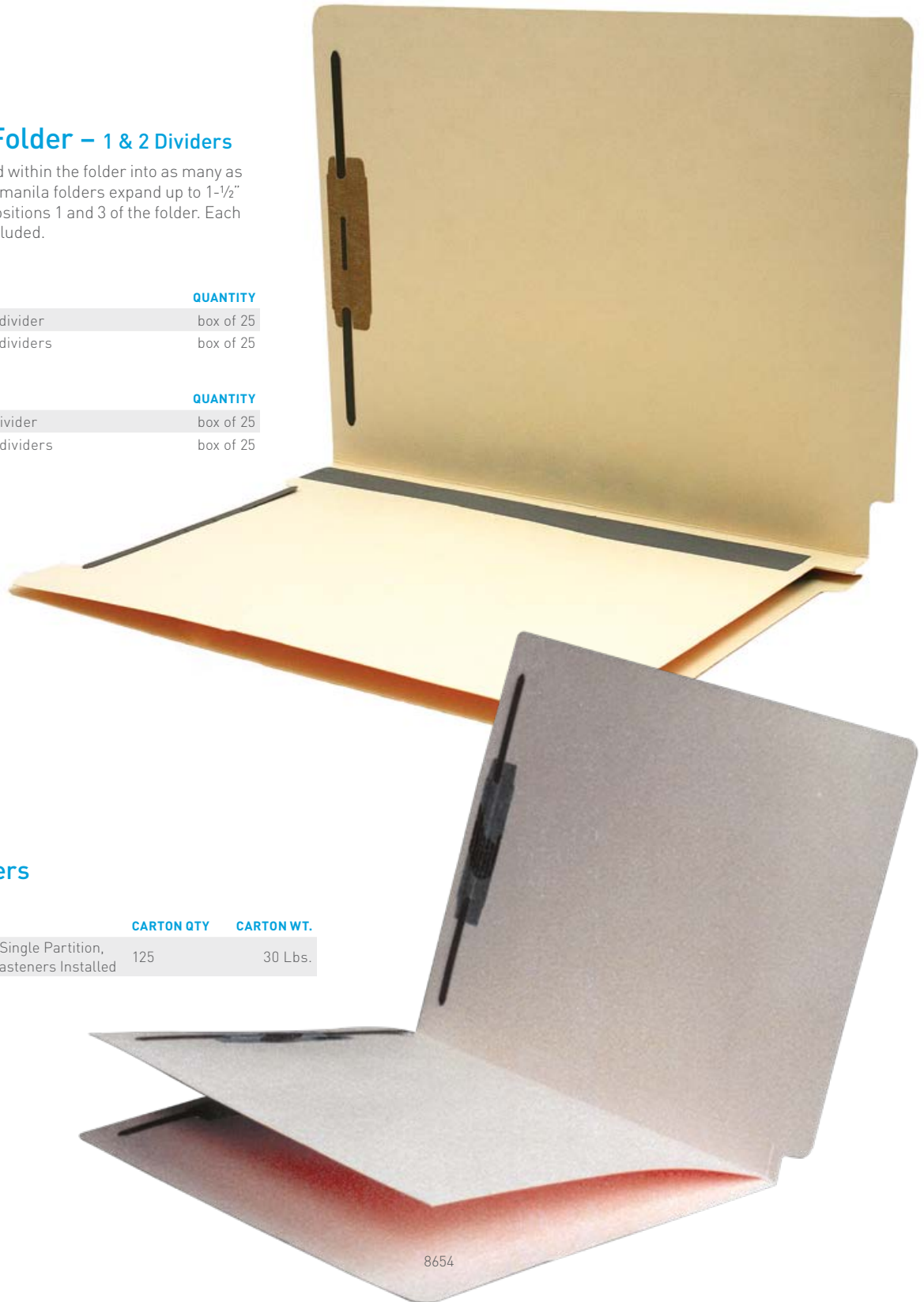

GBS Classifolder Folders

Letter 12-1/4 W x 9-1/2" H

MODEL NO.	DESCRIPTION	CARTON QTY	CARTON WT.
8654	8685 Folder, Blank 11 pt., Single Partition, Glued in (4) 2" Duraclip Fasteners Installed	125	30 Lbs.

Folders – Expansion



TAB 25 pt. Type II Green/Gray Pressboard Standard



Letter

MODEL NO.	DESCRIPTION	QUANTITY
1235-00	1" Expansion Standard	box of 25
1236-00	2" Expansion Standard	box of 25

Legal

MODEL NO.	DESCRIPTION	QUANTITY
1250-00	1" Expansion Standard	box of 25
1251-00	2" Expansion Standard	box of 25



Letter

MODEL NO.	DESCRIPTION	QUANTITY
1237-00B	1" Expansion w/fasteners 1&3	box of 25
1238-00B	2" Expansion w/fasteners 1&3	box of 25
1249-00B	2" Expansion w/fasteners 1	box of 25

Legal

MODEL NO.	DESCRIPTION	QUANTITY
1252-00B	1" Expansion w/fasteners 1&3	box of 25
1253-00B	2" Expansion w/fasteners 1&3	box of 25

TAB 25 pt. Type II Green/Gray Pressboard with 2" Bonded Fasteners



TAB 25 pt. Type II Green/Gray Pressboard 2TAB

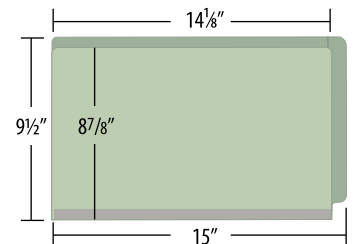
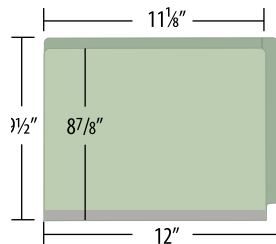

Letter

MODEL NO.	DESCRIPTION	QUANTITY
1348-00	1" Expansion Standard	box of 25
1349-00	2" Expansion 2TAB	box of 25

Legal

MODEL NO.	DESCRIPTION	QUANTITY
1350-00	1" Expansion 2TAB	box of 25
1351-00	2" Expansion 2TAB	box of 25

Folders – Expansion

Datafile® Pressboard Expansion Folder with Full Side Tab

For heavy duty filing applications, these 25 pt. folders are available in letter, metric and legal, with 1" or 2" expansion.

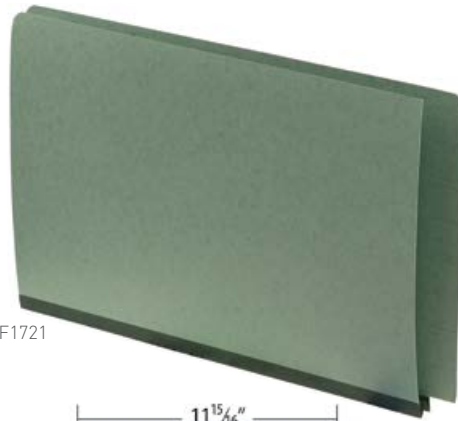

Model: F1721

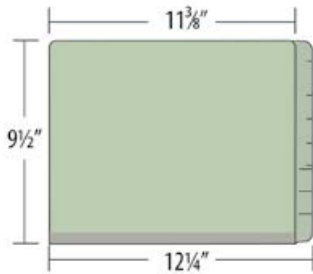

Letter

MODEL NO.	DESCRIPTION	QUANTITY
F1711	25 pt Letter, 1" exp	box of 100
F1712	25 pt Letter, 2" exp	box of 100

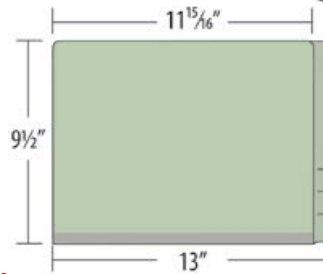

Metric

MODEL NO.	DESCRIPTION	QUANTITY
F1751	25 pt Metric, 1" exp	box of 100
F1752	25 pt Metric, 2" exp	box of 100

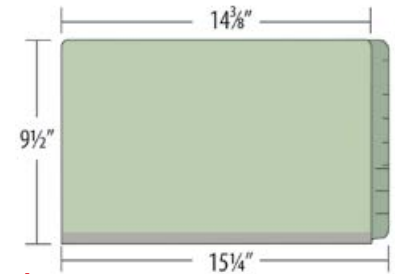

Legal

MODEL NO.	DESCRIPTION	QUANTITY
F1721	25 pt Legal, 1" exp	box of 100
F1722	25 pt Legal, 2" exp	box of 100

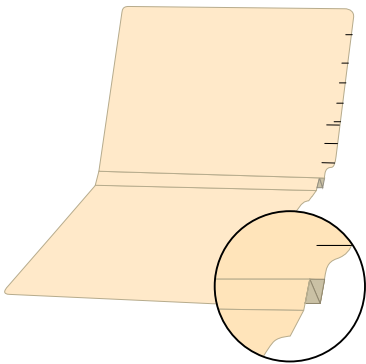

Alternatives to Pressboard TAB 1 1/2" "W" Expansion Folder

These sturdy 18 pt. manila folders have a paper W-fold on the bottom that expands to hold up to 1 1/2" of documents.

Letter

MODEL NO.	DESCRIPTION	QUANTITY
1196-00	9 1/2" h" x 11 3/4" w x 12 1/4" w overall	box of 50

Legal

MODEL NO.	DESCRIPTION	QUANTITY
1197-00	9 1/2" h" x 14 3/4" w x 15 1/4" w overall	box of 50

Expandable Folders and Pockets

Jeter Extra Capacity W-Fold Super Coders

Letter and Legal Size Our W-fold file folder has the largest capacity of all folders, housing a full 2" of documents. This folder comes with a Super Coder reinforced tab of 14-point manila, is pre-folded and available with or without fasteners.

Letter 12-1/4" W x 9-1/2" H with 2" Capacity

MODEL NO.	DESCRIPTION	BOX/CARTON	WT/CARTON
J2241-W	14 pt. Double Ply	50/200	28

Legal 15-1/4" W x 9-1/2" H with 2" Capacity

MODEL NO.	DESCRIPTION	BOX/CARTON	WT/CARTON
J2441-W	14 pt. Double Ply	25/200	22

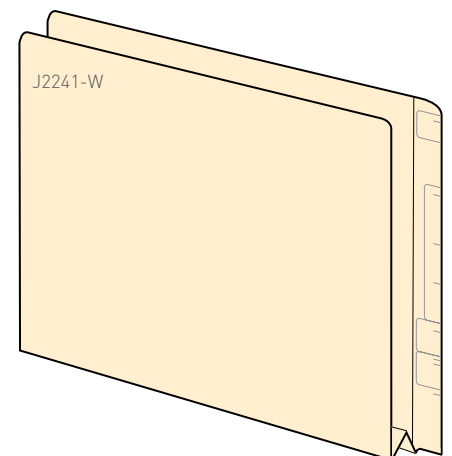

Folders – Expansion

AMES DuraTab Reinforced Expansion Folders

AMES 15 point manila expansion folders come with DuraTab interlocking double reinforced top and side tabs that stand up to frequent use.

- Side tab folders are designed for open shelf filing and feature outline blocks on the tabs for optional color-coded tapes.
- 2" tear-resistant Tyvek® gusset allows for durable expansion.
- Folders are scored above the fold for self expansion.

MODEL NO.	DESCRIPTION	SIZE	LBS./BOX	QUANTITY
OCFVX	15 pt., side tab, 2" gusset	9-1/2" x 12-1/8"	47.5 lbs.	box of 250

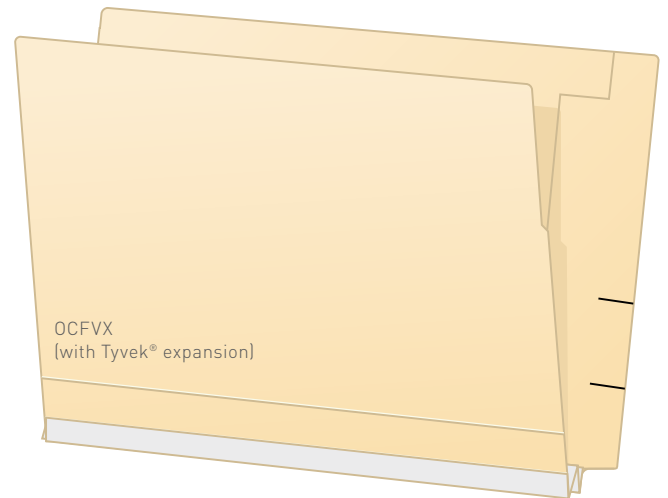

AMES Tyvek® Expansion Pressboard Folders

- Made of durable 25 point Type II pressboard.
- 2" tear-resistant Tyvek® gusset allows for durable expansion.
- Color: Green Grey.

OPRS-ST & OPRS-STEZ:

- 1/2" drop front with side tab
- Designed for open-shelf filing.
- OPRS-STEZ comes with Easiclip in position 5.

MODEL NO.	DESCRIPTION	SIZE	LBS./BOX	QUANTITY
OPRS-ST	Side tab, drop front	9-1/2" x 12-1/8"	40 lbs.	box of 100
OPRS-STEZ	Side tab, drop front, Easiclip	9-1/2" x 12-1/8"	44 lbs.	box of 100

Tyvek is a registered trademark of DuPont.

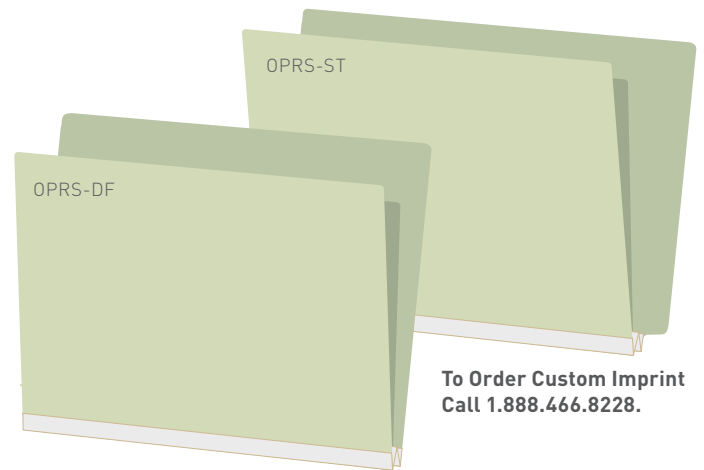

To Order Custom Imprint
Call 1.888.466.8228.



GBS Expansion Folder

Letter 12 W x 9-1/2" H

MODEL NO.	DESCRIPTION	CARTON QTY	CARTON WT.
9155	14 pt., Full End Tab, Reinforced Top & Side, 1 3/4" Expansion, Shipped Flat	250	35 Lbs.

tabZEROfile Folders

A folder that doesn't cost the earth.



Model: CN1228

tabZEROfile™ – Full Side Tab File Folders

tabZEROfile standard folders have full side tabs that are double reinforced for extra durability.

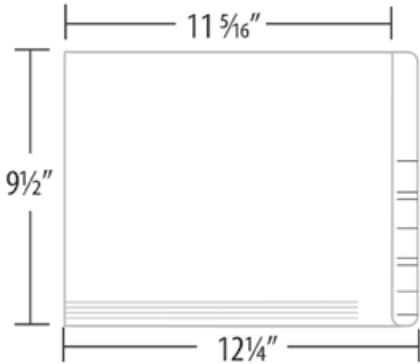

Letter

MODEL NO.	DESCRIPTION	QUANTITY
CN1118	11 pt Letter, white	box of 300
CN1218	14 pt Letter, white	box of 225

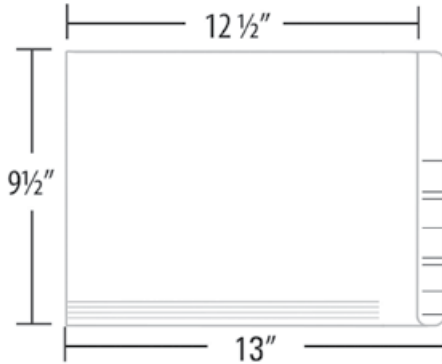

Metric

MODEL NO.	DESCRIPTION	QUANTITY
CN1158	11 pt Metric, white	box of 300
CN1258	14 pt Metric, white	box of 225

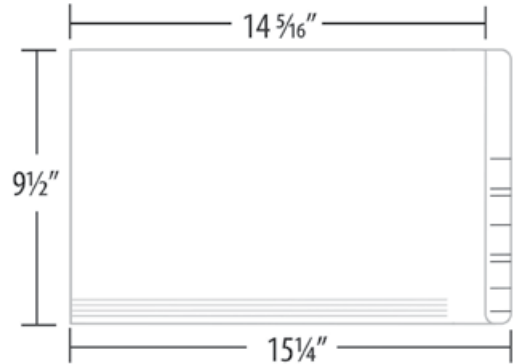

Legal

MODEL NO.	DESCRIPTION	QUANTITY
CN1128	11 pt Legal, white	box of 300
CN1228	14 pt Legal, white	box of 225

tabZEROfile™ – Pressed File Classification Folder with Full Side Tab

For use when segmentation of information is needed within a folder such as mortgage or personnel data. This 25 pt. carbon-neutral pressed folder with white dividers is available with 2" or 3" expansion.

MODEL NO.	DESCRIPTION	DIMENSIONS	QUANTITY
CN101213	25 pt. Letter, 1 divider,* 2" expansion	9 1/2" x 12 1/4"	box of 90
CN102213	25 pt. Legal, 1 divider,* 2" expansion	9 1/2" x 12 1/4"	box of 90
CN101313	25 pt. Letter, 2 dividers,* 3" expansion	9 1/2" x 15 1/4"	box of 70
CN102313	25 pt. Legal, 2 dividers,* 3" expansion	9 1/2" x 15 1/4"	box of 70

*Fasteners included in positions #1 and #3 of folder and positions #1 and #3 of each divider.



FORTifile™ Folders with eternafile™



Environmentally friendly eternafile coating.



The most durable folder products available.

FORTifile folders provide the most durability for your everyday filing requirements. TAB FORTifile folders are fully coated with **eternafile**, an environmentally friendly protective coating that is applied over the entire folder's outer surface, increasing the strength and rigidity of every TAB FORTifile product.

FORTifile White Expansion File Pocket with Notched Side Tab

A low cost alternative to heavy duty expansion pockets while still offering the security of three closed sides.

MODEL NO.	DESCRIPTION	DIMENSIONS H x W	QUANTITY
F1870	14 pt. Legal, 1" expansion	9 1/2" x 15 1/4"	box of 100
F1872	14 pt. Legal, 2" expansion	9 1/2" x 15 1/4"	box of 100



Model: F1870

FORTifile Full Side Tab Folders

Letter

MODEL NO.	DESCRIPTION	QUANTITY
FF4219-**	13 pt Letter Color FORTifile	box of 300

Metric

MODEL NO.	DESCRIPTION	QUANTITY
FF4259-**	13 pt Metric Color FORTifile	box of 300

Legal

MODEL NO.	DESCRIPTION	QUANTITY
FF4229-**	13 pt Legal Color FORTifile	box of 300

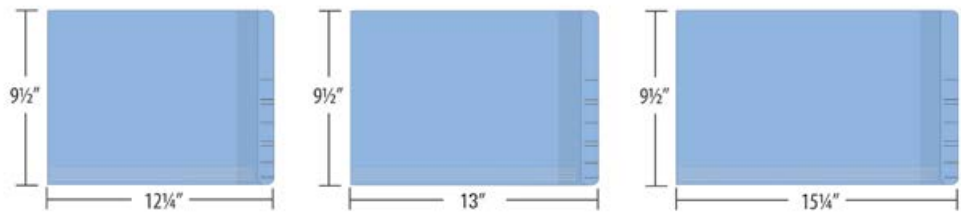

**Choose appropriate color suffix. AB=Azure Blue, MB=Mocha Brown, PW=Pearl White, MG=Mint Green, SY=Spring Yellow, CR=Cranberry Red, HB=Honey Brown



FORTifile Pressed Files

FORTifile pressed files are the answer for heavy duty filing applications and expand to 2". Fasteners are included in positions #1 and #3.

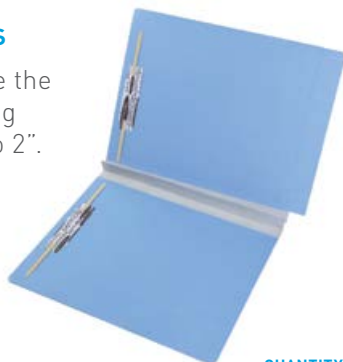

Model: FF4712-AB13

MODEL NO.	DESCRIPTION	QUANTITY
FF4712**13	Letter (9 1/2" h" x 12 1/4" w overall), 2" expansion	box of 80
FF4752**13	Metric (9 1/2" h" x 13" w overall), 2" expansion	box of 100
FF4722**13	Legal (9 1/2" h" x 15 1/4" w overall), 2" expansion	box of 100

FORTifile Pressed Classification Folders

FORTifile classification folders have a built in divider(s) to segment information within a highly durable folder and have a 2" or 3" expansion. Fasteners are included in positions #1 and #3 of folder and in positions #1 and #3 of each divider.



Model: FF4012-CR13

MODEL NO.	DESCRIPTION	QUANTITY
FF4012**13	Letter (9 1/2" h" x 12 1/4" w overall) 2" expansion, 1 divider	box of 80
FF4013**13	Letter (9 1/2" h" x 12 1/4" w overall) 3" expansion, 2 divider	box of 80
FF4053**13	Metric (9 1/2" h" x 13" w overall) 3" expansion, 2 divider	box of 80
FF4022**13	Legal (9 1/2" h" x 15 1/4" w overall) 2" expansion, 1 divider	box of 80
FF4033**13	Legal (9 1/2" h" x 15 1/4" w overall) 3" expansion, 2 divider	box of 80

**Choose appropriate color suffix. AB=Azure Blue, MB=Mocha Brown, PW=Pearl White, MG=Mint Green, SY=Spring Yellow, CR=Cranberry Red, HB=Honey Brown

Pocket Folders – Manila

Keep Documents Safe

With closed sides these pockets keep small items in file with larger documents. Available with two sides closed, three sides closed, manila or color side tab.

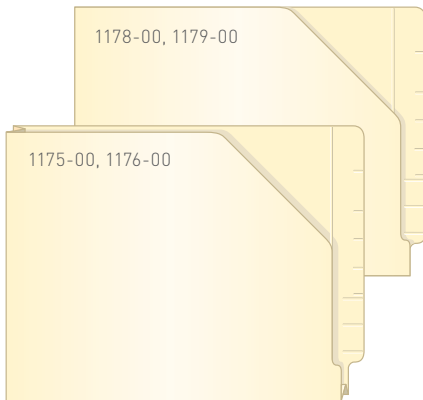

TAB Manila Pockets – Closed 2 Sides

Letter

MODEL NO.	DESCRIPTION	QUANTITY
1178-00	11 pt Manila Flat Pocket	box of 100
1175-00	11 pt Manila Pocket 1½" expansion	box of 50

Legal

MODEL NO.	DESCRIPTION	QUANTITY
1179-00	11 pt Manila Flat Pocket	box of 50
1176-00	11 pt Manila Pocket 1½" expansion	box of 50

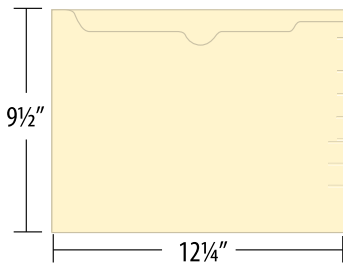

TAB Manila Pockets – Closed 3 Sides

Letter

MODEL NO.	DESCRIPTION	QUANTITY
1168-00	11 pt Manila Flat Pocket	box of 100
1180-00	11 pt Manila Pocket ¾" expansion	box of 100

Legal

MODEL NO.	DESCRIPTION	QUANTITY
1169-00	11 pt Manila Flat Pocket	box of 100
1181-00	11 pt Manila Pocket ¾" expansion	box of 50

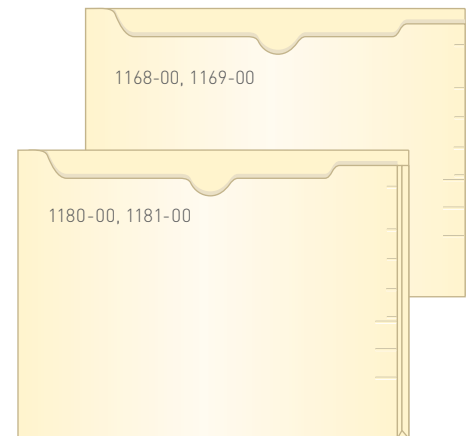
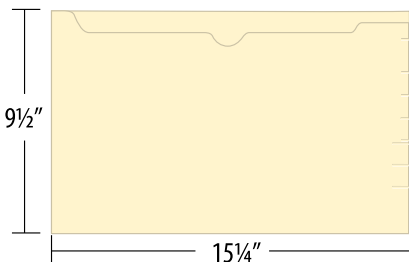

Pocket Folders – Manila

jeter Pockets

Jeter has four standard file pockets for inside any of our file folders. These pockets can be factory-installed to our file folders or ordered separately. Some prefer a loose pocket within a file folder to collect certain documents. Jeter has a variety of stock folders with pockets already installed, see page 10 for more details.

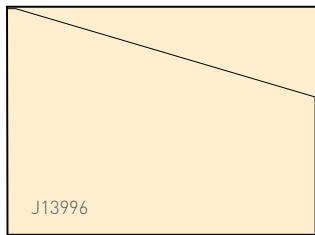

jeter Pocket Open at Top and Right

This pocket is open on two sides, allowing quick access to its contents. Made of 11 point manila stock.

9-1/4" W x 8" H

LOOSE POCKETS

MODEL NO.	PAPER POINT	QTY./CARTON	WT./CARTON
J13996-B	11	100/500	30 Lbs

FACTORY-INSTALLED

MODEL NO.	PAPER POINT	QTY./CARTON	WT./CARTON
J13996	11	100	30 Lbs

* Minimum order quantity of 100

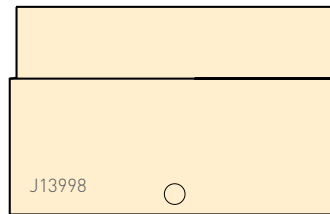

jeter Pocket with Short Front Panel

This pocket has a short front panel for easy access to its contents. Closed on three sides, open at the top. 11 point manila stock.

9-1/4" W x 4-1/4" H

LOOSE POCKETS

MODEL NO.	PAPER POINT	QTY./CARTON	WT./CARTON
J13998-B	11	100/500	30 Lbs

FACTORY-INSTALLED

MODEL NO.	PAPER POINT	QTY./CARTON	WT./CARTON
J13998	11	100	30 Lbs

* Minimum order quantity of 100

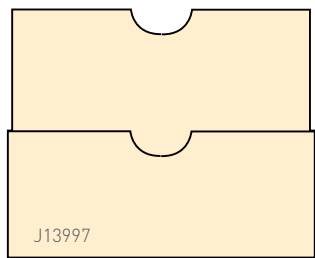

jeter Two Pocket Design

This unique 11 point manila pocket makes for two separate pockets to organize and separate the contents of your folders. Not recommended to be used loose.

9" W x 8-1/2" H rear pocket, 9" W x 5" H front pocket

LOOSE POCKETS

MODEL NO.	PAPER POINT	QTY./CARTON	WT./CARTON
J13997-B	11	100	30 Lbs

FACTORY-INSTALLED

MODEL NO.	PAPER POINT	QTY./CARTON	WT./CARTON
J13997	11	250	30 Lbs

* Minimum order quantity of 250

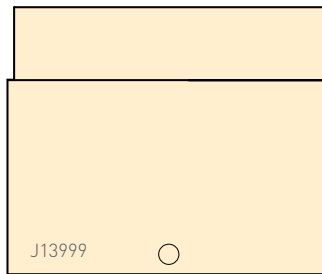

jeter Pocket with Tall Front Panel

This pocket has a tall front panel to securely hold smaller documents, such as photos. 11 point manila stock.

9-1/4" W x 6-3/4" H

LOOSE POCKETS

MODEL NO.	PAPER POINT	QTY./CARTON	WT./CARTON
J13999-B	11	100/500	30 Lbs

FACTORY-INSTALLED

MODEL NO.	PAPER POINT	QTY./CARTON	WT./CARTON
J13999	11	100	30 Lbs

* Minimum order quantity of 100

jeter Pocket Organizers for Desktop Use

Organize and collect daily work in Jeter Pocket organizers. These pockets are made of 11 point manila and come with printing available in three separate colors. Use these instead of file folders to collect documents concerning one matter. They also work well in place of a paper clip. Form pre-printed on front for notes about pocket contents.

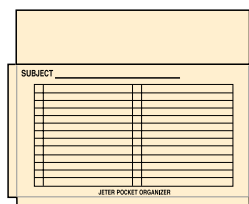

J13994

9-5/8" W x 6-3/4" H

MODEL NO.	PRINT COLOR	PAPER POINT	QTY./PACKAGE	WT./CARTON
J13994	Black	11	50/pkg	3 Lbs
J13994-G	Green	11	50/pkg	3 Lbs
J13994-R	Red	11	50/pkg	3 Lbs

Pocket Folders – Manila

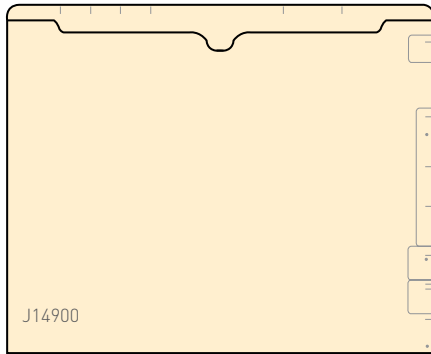

Jeter Pocket File Folders

File pockets are ideal for odd-sized documents. The closed sides prevent the loss of small lab slips, photographs and other small media.

MODEL NO.	DESCRIPTION	BOX/CARTON	WT/CARTON
Top Loading Style 11-3/4" W x 9-1/2" H			
J14900	14 pt. Single Ply	100/400	42
Top Loading Style 12-1/4" W x 9-1/2" H			
J14901	14 pt. Single Ply	100/400	42

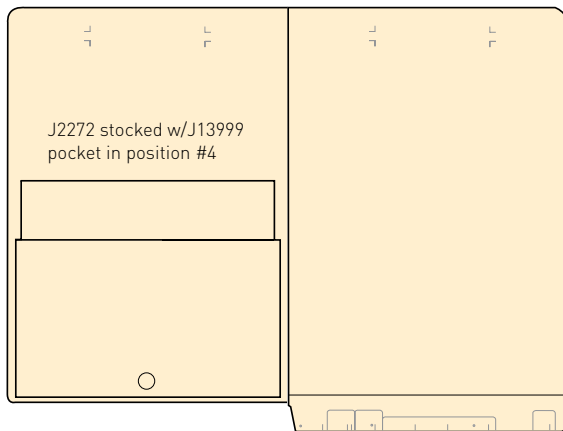

Jeter Super Coders with Pockets

Many organizations find pockets inside file folders to be a sound way to deal with small documents, photographs or labor reports. Sometimes, pockets are used to segregate certain documents that carry signatures and other data. Jeter manufactures a broad variety of pockets, and our most popular file folders are stocked with pockets and/or fasteners.

12-1/4" W x 9-1/2" H

MODEL NO.	DESCRIPTION	FASTENER POSITION	BOX/CARTON	WT/CARTON
J2272	14 pt. Double Ply	N/A	50/250	43
J2272-56	14 pt. Double Ply	1	50/250	45
J2272-58	14 pt. Double Ply	1+3	25/125	25

GBS One Piece Pocket Folder

Letter

MODEL NO.	DESCRIPTION	CARTON QTY	CARTON WT.
8600	11 pt., Top Opening, 11 3/4" x 9 1/2"	300	29 Lbs.
8601	11 pt., Top Opening, 12 1/4" x 9 1/2"	300	29 Lbs.
8607	14 pt., End & Top Opening, 12 1/4" x 9 1/2"	500	62 Lbs.
8611	11 pt., Top Opening, 3/4" Expansion, 12 1/4" x 9 1/2"	250	26 Lbs.

AMES Full Pocket File Folder

Letter

MODEL NO.	DESCRIPTION	QUANTITY
1139-00	11 pt Manila letter size, full single ply side tab, closed 3 sides	box of 50
1139-00B13	17 pt Manila letter size, full single ply side tab, Bonded 2" fasteners in positions 1 and 3	box of 50



Pocket Folders – Color and Color Stripe

TAB Manila Color Stripe Flat Pockets – Closed 2 Sides

Letter

MODEL NO.	DESCRIPTION	QUANTITY
1172-**-	11 pt Color Stripe Flat Pocket	box of 100

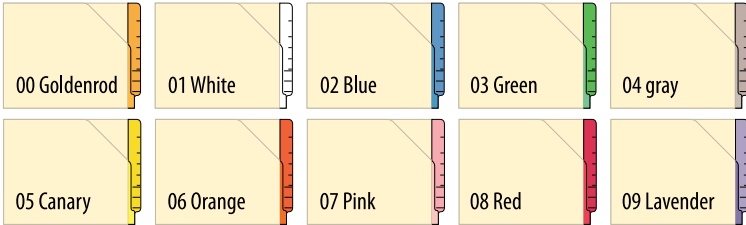

**Choose appropriate color suffix:

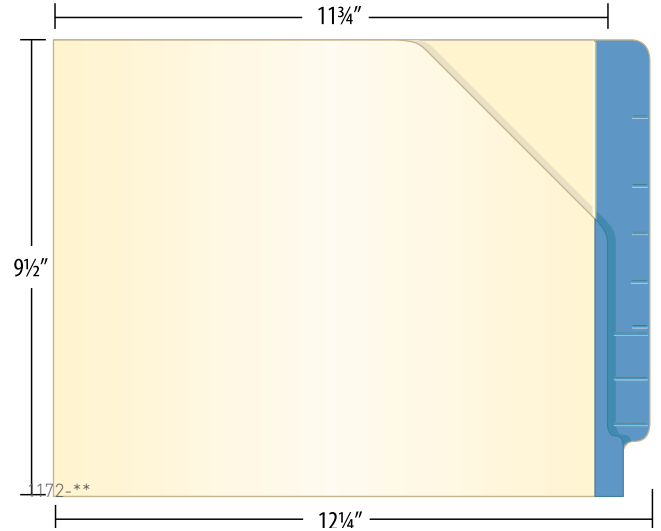

TAB Color One-Piece Pockets

Letter

MODEL NO.	DESCRIPTION	QUANTITY
1174-**-	11 pt Color One Piece Flat Pocket closed two sides	box of 100
1184-**-	11 pt Color One Piece Pocket w/ 4" Lower End Tab	box of 100
1166-**-	11 pt Color Flat Pocket closed 3 sides	box of 100

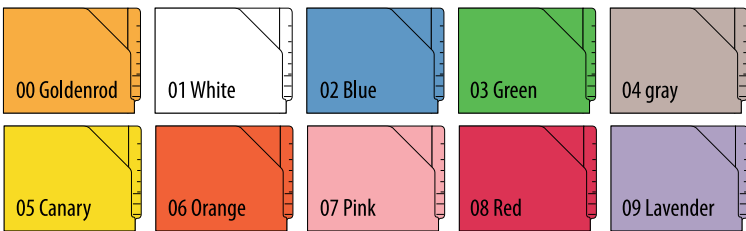

**Choose appropriate color suffix.



AMES Color Slash-Cut Pockets

Organize by color while keeping a portion of your contents visible for quick identification with AMES Slash-Cut Pockets. Ideal for holding information that you do not want to staple or clip together.



- Open end design helps secure contents in pocket.
- Made of durable 11 point stock with glued 1" side seams.
- Size: 9-3/4" x 11-1/2".

MODEL NO.	LBS./BOX	QUANTITY
See below	14 lbs.	box of 200

Blue	Canary	Green	Pink	Purple	Scarlet	Tan
SLH-BL	SLH-CA	SLH-GR	SLH-PI	SLH-PU	SLH-SC	SLH-TA

Pockets Folders – Expansion

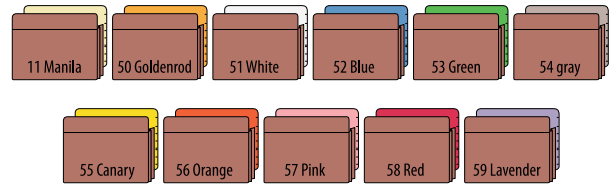

**Choose appropriate color suffix.

TAB 22 pt. Red Rope Expansion Pockets with Color Backs Red rope front and gusset, color back, gusset height 6 1/2"

Letter

MODEL NO.	DESCRIPTION	QUANTITY
1187-**	1 3/4" Standard Color Back Expansion Pockets	box of 50
1189-**	3 1/2" Standard Color Back Expansion Pockets	box of 50
4387-**	5 1/4" Standard Color Back Expansion Pocket	box of 50

Legal

MODEL NO.	DESCRIPTION	QUANTITY
1191-**	1 3/4" Standard Color Back Expansion Pocket	box of 50
1193-**	3 1/2" Standard Color Back Expansion Pockets	box of 50
4397-**	5 1/4" Standard Color Back Expansion Pocket	box of 50

TAB 22 pt. Standard Solid Color Expansion Pockets

Letter

MODEL NO.	DESCRIPTION	QUANTITY
1379-**	3 1/2" Standard Solid Color Expansion Pockets	box of 50

Legal

MODEL NO.	DESCRIPTION	QUANTITY
1381-**	3 1/2" Standard Solid Color Expansion Pockets	box of 50



**Choose appropriate color suffix.

Low Gusset Expansion Pockets

TAB 22 pt. Red Rope Front and Bright Goldenrod Back

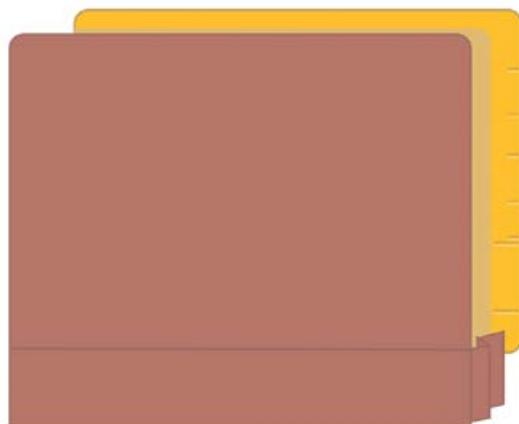

Red rope front and gusset, goldenrod back, left gusset height 9", right gusset height 1 1/2"

Letter

MODEL NO.	DESCRIPTION	QUANTITY
1187-00	1 3/4" Expansion [9 1/2" h, 11 3/4" w x 12 1/4" w overall]	box of 50
1189-00	3 1/2" Expansion [9 1/2" h, 11 3/4" w x 12 1/4" w overall]	box of 50

Legal

MODEL NO.	DESCRIPTION	QUANTITY
1191-00	1 3/4" Expansion [9 1/2" h, 14 3/4" w x 15 1/4" w overall]	box of 50
1193-00	3 1/2" Expansion [9 1/2" h, 14 3/4" w x 15 1/4" w overall]	box of 50

Pockets Folders – Expansion



TAB 22 pt. Expansion Pockets

Letter

MODEL NO.	DESCRIPTION	QUANTITY
F5600	1 ³ / ₄ " Expansion Lavender	box of 50
F5650	3 ¹ / ₂ " Expansion Lavender	box of 50
F5610	5 ¹ / ₄ " Expansion Lavender	box of 50

Legal

MODEL NO.	DESCRIPTION	QUANTITY
F5700	1 ³ / ₄ " Expansion Lavender	box of 50
F5750	3 ¹ / ₂ " Expansion Lavender	box of 50
F5755	3 ¹ / ₂ " Expansion Red Rope	box of 50

TAB Expansion Pockets 42 pt. backs, 28 pt. Front

Letter

MODEL NO.	DESCRIPTION	QUANTITY
F1832	1 ³ / ₄ " Expansion Red Rope	box of 50
F1834	3 ¹ / ₂ " Expansion Red Rope	box of 50

Long Letter

MODEL NO.	DESCRIPTION	QUANTITY
F1852	1 ³ / ₄ " Expansion Red Rope Long Letter 13" W	box of 50
F1854	3 ¹ / ₂ " Expansion Red Rope Long Letter 13" W	box of 50

Legal

MODEL NO.	DESCRIPTION	QUANTITY
F1842	1 ³ / ₄ " Expansion Red Rope	box of 50
F1844	3 ¹ / ₂ " Expansion Red Rope	box of 50

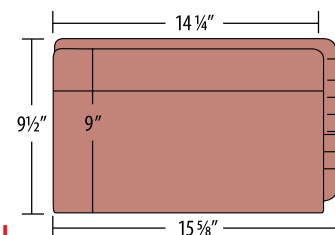
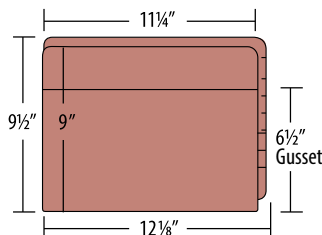

TAB Top Tab Expansion Pockets 22 pt. Red Rope, Gusset height 6 1/2"

Letter

(9" high front; 9 1/2" high back x 11 3/4" wide)

MODEL NO.	DESCRIPTION	QUANTITY
1130-00	1 ³ / ₄ " Expansion	box of 50
1131-00	3 ¹ / ₂ " Expansion	box of 50

Legal

(9" high front; 9 1/2" high back x 14 3/4" wide)

MODEL NO.	DESCRIPTION	QUANTITY
1132-00	1 ³ / ₄ " Expansion	box of 50
1133-00	3 ¹ / ₂ " Expansion	box of 50

TAB Well File Folder

These 6-part legal, classification folders with attached 4" expansion pocket are the answer for drilling, technical, correspondence, government/regulatory, financial and completions with well logs filed in the pocket.

Legal

MODEL NO.	DESCRIPTION	QUANTITY
CN1923	25 pt., 4" expansion, 6 part well file	box of 30



tabZEROfile™ Expansion File Pocket with Full Side Tab

These high quality carbon-neutral expansion file pockets offer maximum filing capacity for storage of bulky documents, computer printouts and documents of assorted sizes. Triple thick back panels are 28 pt. and triple thick front panels are 28 pt. Full side tab pockets have Tyvek® gussets and will expand to 4".

MODEL NO.	DESCRIPTION	DIMENSIONS	QUANTITY
CN1844	Legal, 4" expansion	9 1/2" x 15 1/4"	box of 50

Pockets Folders – Expansion

Expandable Folders and Pockets

Jeter Extra Capacity W-Fold Super Coders

Letter and Legal Size Our W-fold file folder has the largest capacity of all folders, housing a full 2" of documents. This folder comes with a Super Coder reinforced tab of 14-point manila, is pre-folded and available with or without fasteners.

Letter 12-1/4" W x 9-1/2" H with 2" Capacity

MODEL NO.	DESCRIPTION	BOX/CARTON	WT./CARTON
J2241-W	14 pt. Double Ply	50/200	28

Legal 15-1/4" W x 9-1/2" H with 2" Capacity

MODEL NO.	DESCRIPTION	BOX/CARTON	WT./CARTON
J2441-W	14 pt. Double Ply	25/200	22

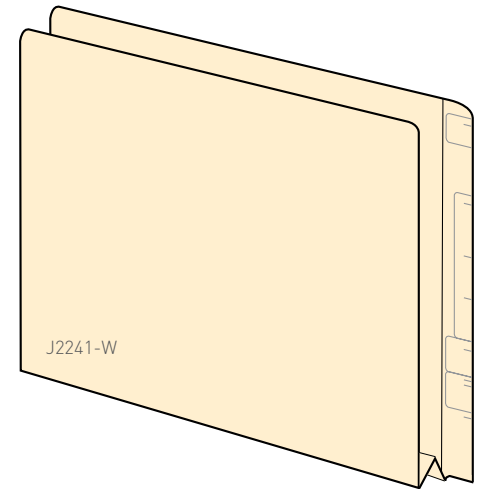

Jeter Manila Expansion Pockets

Jeter expansion pockets have many premium attributes, including:

- Superior Quality
- Maximum Gusset Strength
- Extra Deep Glued Edge Adds Durability
- Extra Strong Corners
- Longer Pocket Tabs for Better Label Fit
- Extra Heavy Covers, Front & Back

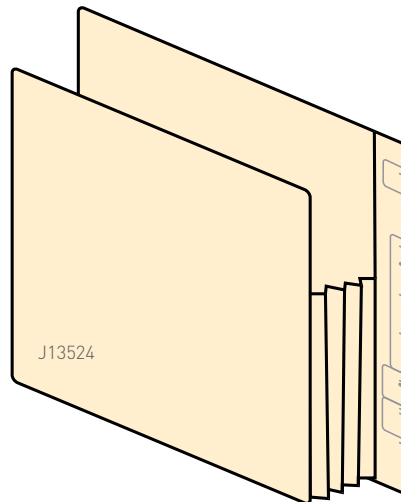

Letter 12-3/8" wide x 9-1/2" high, 14 pt., Double Ply

MODEL NO.	EXPANSION	QTY./CARTON	WT./CARTON
J13514	1-3/4"	50	11
J13524	3-1/2"	50	11
J13534	5-1/4"	50	16

Legal 15-3/8" wide x 9-1/2" high, 14 pt., Double Ply

MODEL NO.	EXPANSION	QTY./CARTON	WT./CARTON
J13516	1-3/4"	50	14
J13526	3-1/2"	50	16
J13536	5-1/4"	50	20

AMES DuraTab Reinforced Expansion Folders

AMES 15 point manila expansion folders come with DuraTab interlocking double reinforced top and side tabs that stand up to frequent use.

- Side tab folders are designed for open shelf filing and feature outline blocks on the tabs for optional color-coded tapes.
- 2" tear-resistant Tyvek® gusset allows for durable expansion.
- Folders are scored above the fold for self expansion.

MODEL NO.	DESCRIPTION	SIZE	LBS./BOX	QUANTITY
OCFVX	15 pt., side tab, 2" gusset	9-1/2" x 12-1/8"	47.5 lbs.	box of 250

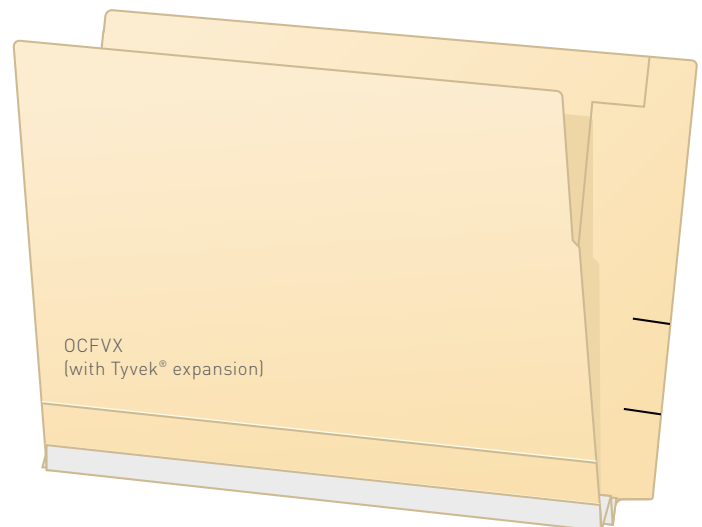

Health Care – X-Ray

Jeter Dental Pocket Super Coders

The J2274 Super Coder is a special, longer size folder which accepts panoramic x-ray films within its inner pocket, #J13998.

13-3/8" W x 9-1/2" H

MODEL NO.	DESCRIPTION	FASTENER POSITION	BOX/CARTON	WT/CARTON
J2274	14 pt. Double Ply	N/A	50/250	41
J2274-56	14 pt. Double Ply	1	25/125	23

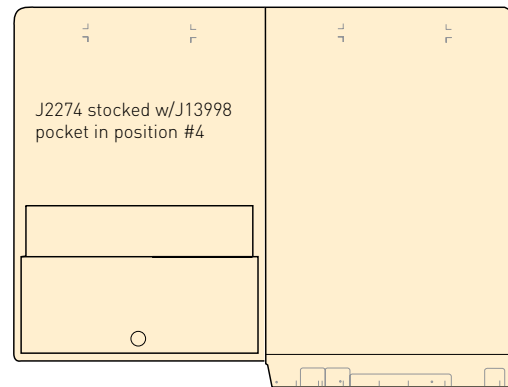

One Piece Manila X-Ray Jackets 14 1/2" x 18 1/4"

MODEL NO.	DESCRIPTION	QUANTITY
1177-00	11 pt. flat	box of 100
1177-25	11 pt. flat	box of 100

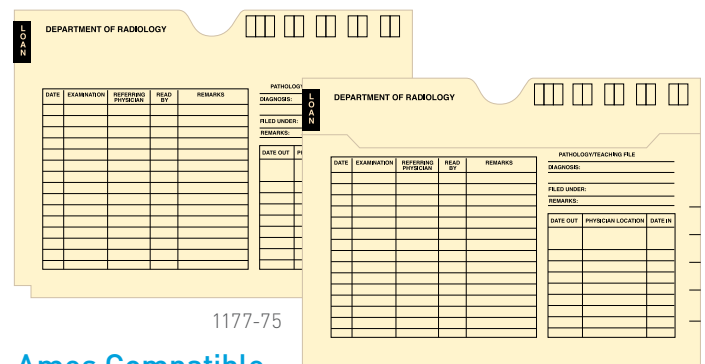

Ames Compatible One Piece Manila X-Ray Jackets 14 1/2" x 18 1/4" x 3/4"

MODEL NO.	DESCRIPTION	QUANTITY
1177-75	11 pt. 3/4" expandable	box of 100
1177-50	11 pt. dual pocket	box of 100

AMES Standard Copy Color-Coded X-Ray Jackets

AMES Standard Copy Color-Coded X-Ray Jackets feature terminal digit color coded numbering with year code.

- Size: 14-1/2" x 18-1/4", including 3/4" self expansion.
- Made of 11 point manila stock.
- Available with or without natural wallet border.
- Two printed AMES color bars on both sides.
- Stock copy includes printed outline blocks for taping codes and loan indicator bar.
- Indicator bar shows when jacket is turned around on shelf, indicating films are on loan.
- Scored for easy expansion.
- Offset double thumbcut for easy access to contents.
- Open-side design (opens along long edge).

MODEL NO.	DESCRIPTION	QUANTITY	LBS./BOX
OCXE-DST	Stock copy	box of 100	21 lbs.
OCXE-NST	Stock copy, natural wallet border	box of 100	21 lbs.
OCXE-DF-PL	Plain, no printing	box of 100	21 lbs.

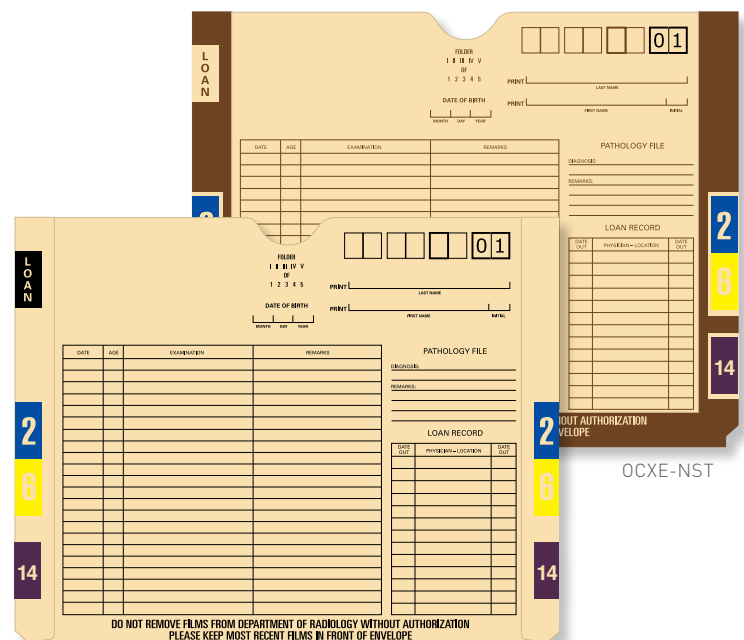

Health Care– X-Ray

jeter X-Ray Category Inserts

Locate specific examinations at a glance using solid-color and printed border stock color systems.

- Manufactured of 40 lb. kraft stock.
- Color coding by category permits quick location of films.
- Open-side category name printed on both sides of thumbcut, and open-end style features category name on top and bottom for easy identification.
- All inserts are available in open-end and open-side styles.
- Choose from 2 sizes:
 - 14-1/4" x 17-1/2" and
 - 10-1/2" x 12-1/2"
- Black copy, except where noted.



NOW PACKED 250/BOX!

MODEL NO.	DESCRIPTION	QUANTITY	LBS./BOX
See below	Size: 14-1/4" x 17-1/2"	box of 250	21 lbs.
See below	Size: 10-1/2" x 12-1/2"	box of 250	21 lbs.

14-1/4" x 17-1/2"		10-1/2" x 12-1/2"		CATEGORY	STOCK COLOR	BORDER COLOR	COPY COLOR
OPEN-END MODEL NO.	OPEN-SIDE MODEL NO.	OPEN-END MODEL NO.	OPEN-SIDE MODEL NO.				
-	CXIOS-AN	-	-	Angio	White	Purple	Black
CXIOE-BN	CXIOS-BN	-	-	Bone	White	Yellow	Black
-	CXIOS-GU	-	-	GU	White	Orange	Black
-	CXIOS-HN	-	-	Head & Neck	White	Light Blue	Black
CZIOE-MAM	-	MCXIOE-MAM-250	MCXIOS-MAM-250	Mammography	White	Pink	Black
-	PC-OS-MAM	PC-OE-MMM-250	-	Mammography	White	Dark Blue	Black
CXIOE-MRI	-	-	-	MRI	White	Black	Black
PC-OE-SE	-	-	-	Spine	White	Black	Black
-	-	PC-OE-MUS-250	-	Ultrasound	White	-	Black
CXIOE-MC	CXIOS-MC	-	-	Miscellaneous	White	-	None
CXIOE-PL	CXIOS-PL	-	MCXIOS-PL-250	Blank (no copy)	White	Dark Blue	Black
-	CXIOS-NC	-	-	Standard copy, no category	White	-	-

Health Care – Folders

AMES Standard Color-Coded File Folders

AMES DuraTab double-reinforced manila folders are labeled with 2 numeric color bars using the AMES Ten-Color System.

- Straight numerical collation.
- Standard size: 9-1/2" x 12-1/8".
- Choose 11 point or 14 point manila stock.
- 2CFV comes with 5 each of 00 to 99 per box; 2CFV15 comes with 2 each of 00 to 99 per box. Both collated in straight numeric order.
- DuraTab interlocking double-reinforced right side tab and top.
- Double-scored 1/2" and 1-3/8" above fold for expansion.

MODEL NO.	DESCRIPTION	LBS./BOX	QUANTITY
2CFV	11 pt. folder	46 lbs.	box of 500
2CFV15	14 pt. folder	32 lbs.	box of 200

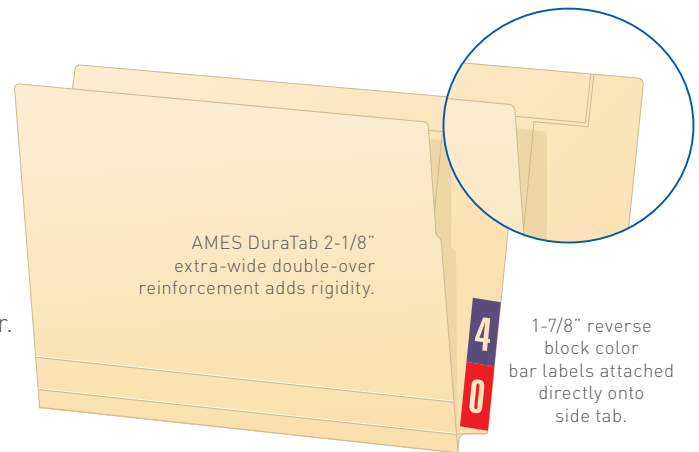

To Order Custom Imprint Call 1.888.822.9777.

AMES Stock Copy File Folders With or Without Color Bar Labels

AMES DuraTab double-reinforced folders with stock copy that includes name line and year barometer.

- Size: 9-1/2" x 12-1/8".
- Choose 11 point or 14 point manila stock with same construction as folders above.
- Folders with terminal digit color coded numbering are collated in straight numeric order.
- 2CFV-ST is packed 5 each of 00 to 99 per box; 2CFV15-ST is packed 2 each of 00 to 99 per box.



To Order Custom Imprint Call 1.888.466.8228.

MODEL NO.	DESCRIPTION	LBS./BOX	QUANTITY
2CFV-ST	2 color bar labels, 11 pt.	46 lbs.	box of 500
2CFV15-ST	2 color bar labels, 14 pt.	25.6 lbs.	box of 200
OCFV-ST	No color bar labels, 11 pt.	46 lbs.	box of 500
OCFV15-ST	No color bar labels, 14 pt.	32 lbs.	box of 250

AMES VNA Folders

Developed specifically by and for Visiting Nurses Associations across the country.

- Overall size: 9-1/2" x 12-1/8" with a 3/4" side tab.
- Made of strong 15 point manila stock.
- Standard copy printed on front and back in black.
- Reinforced side tab and top for added durability.
- Scored for self expansion.

MODEL NO.	UNIT	QUANTITY
OCF-VNA	250/box	box of 250

For CXE models add two-digit year code for appropriate year; for example: CXE-DF-ST-16 for 2016

See page 37 for VNA Tab Dividers.

PATIENT NAME _____ FIRST _____ M.I. _____ LAST _____

ADDRESS _____

ADDRESS _____ TELEPHONE NUMBER _____

ATTENDING PHYSICIAN _____ TEL: _____

ADDRESS _____

ADDRESS _____

EMERGENCY CONTACT _____ RELATIONSHIP _____

ADDRESS _____ TEL: _____

ADDRESS _____

DIRECTIONS TO HOME: _____

Vol ____ of ____

Health Care – Dividers



AMES VNA Tab Dividers

Set of 10 dividers with printed tabs designed to coordinate with our VNA folders.

- Overall size: 9" x 11", including 1/2" tab.
- Made of white tag stock with polyester laminated, color tabs.
- Polyester reinforced top and side holes for use with any folder.

MODEL NO.	LBS./BOX	QUANTITY
TAB-VNA	32 lbs.	100 sets/box

TAB	COLOR	TAB TEXT
1	Blue	ORDERS
2	White	NURSES NOTES
3	Purple	PHYSICAL THERAPY NOTES
4	Pink	SPEECH THERAPY NOTES
5	Yellow	OCCUPATIONAL THERAPY NOTES
6	Green	SOCIAL WORK NOTES
7	Grey	HOME HEALTH AIDE
8	Red	LAB
9	Brown	MISC.
10	Orange	BILLING ANCILLARY / CORRESPONDENCE



AMES Stock Copy Chart Dividers

Set of eight dividers comes with standard copy printed on both sides of polyester laminated color tabs.

- Overall size: 9" x 11", including 1/2" side tab.
- Made of white tag stock.
- Polyester reinforced top and side holes for use with 3-ring binders or folders with fasteners.

MODEL NO.	LBS./BOX	QUANTITY
TAB-MR	30 lbs.	100 sets/box

TAB	COLOR	TAB TEXT
1	Blue	HISTORY & PHYSICAL
2	Yellow	PROGRESS NOTES
3	Orange	CORRESPONDENCE
4	Green	LAB/X-RAY
5	Red	HOSPITAL
6	Brown	INSURANCE
7	Pink	MISCELLANEOUS
8	Clear/Frosty	blank (writable)

AMES "Admission" Tab Dividers

Tab positions 1 through 4 are printed with "Admission 1" through "Admission 4". Reverse side of tabs is printed "Admission" without numbering so you can flip the dividers for use in positions 5 through 8.

- Overall size: 9" x 11", including 1/2" tab.
- Made of white tag stock.
- Eighth-cut tab dividers along long edge.
- Blue polyester laminated tabs with black copy on both sides of tab.
- Choose reinforced top and bottom holes or reinforced side holes.

MODEL NO.	TAB TITLE	HOLE PUNCH POSITIONS	LBS./BOX	QUANTITY
TAB-DIV-ST1	1st Admission	2 hole-punched	8 lbs.	box of 250
TAB-DIV-ST1-SE	1st Admission	4 hole-punched:	8 lbs.	box of 250

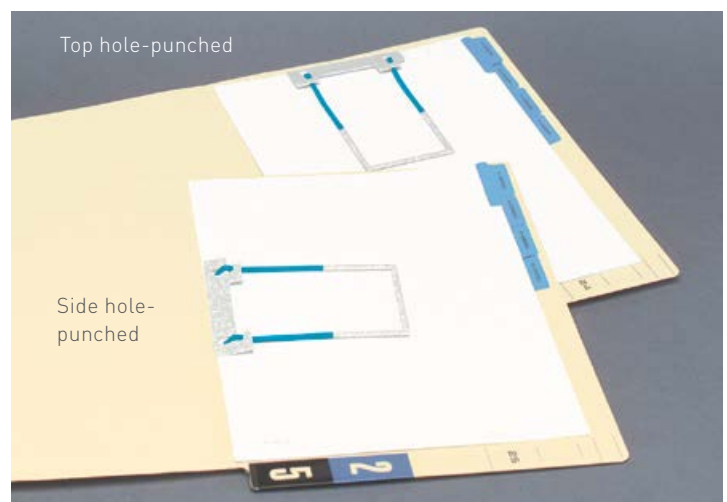

(Folders and Easyclips sold separately.)

Make the Survey Process Easier and More efficient

AMES Medical Staff Services Credential Files

Organize your credential files and make the survey process easier and more efficient. Each file is designated as confidential.

- Made of sturdy 25 point pressboard.
- Tyvek® gusset expansion holds up to 2" of documents.
- AMES Easiclip (in Position #1, shown right).
- 10 color-categorized tab dividers to a set.
- Folders and dividers sold separately.

MODEL NO.	DESCRIPTION	LBS./BOX	QUANTITY
FLD-MD	Folders	44 lbs.	box of 100
CD-MD	Divider Sets	16 lbs.	box of 50

To Order Custom Folders & Dividers or Divider Installation, call 1-800-343-2040.

TAB	COLOR	TAB TEXT
1	Red	RECOMMENDATIONS/REVIEW & ACTIONS
2	Blue	PRIVILEGES
3	Yellow	APPLICATION
4	Green	REFERENCES/AFFILIATIONS/TRAINING/MED.SCH.
5	White	MALPRACTICE COVERAGE & HISTORY/NPDB OUT OF STATE LICENSE
6	Purple	STATE LICENSE & APP/DEA
7	Pink	ADVANCED CERTIFICATES / CME
8	Grey	INTERNAL REPORTS / REQUIREMENTS
9	Brown	CORRESPONDENCE / MISC.
10	Orange	REFERENCES SENT



Indexes – Title Sets

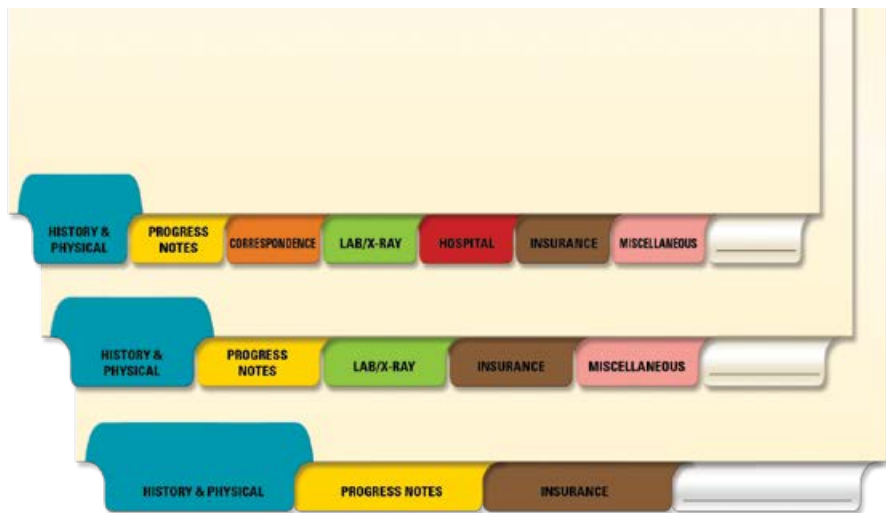

INTRODUCING Three New Standard Health Care Title Sets

Available in styles A, B & C

90# manila stock; 1/2" tab extension; collated into sets. End tab is blank for easy-to-write titles.

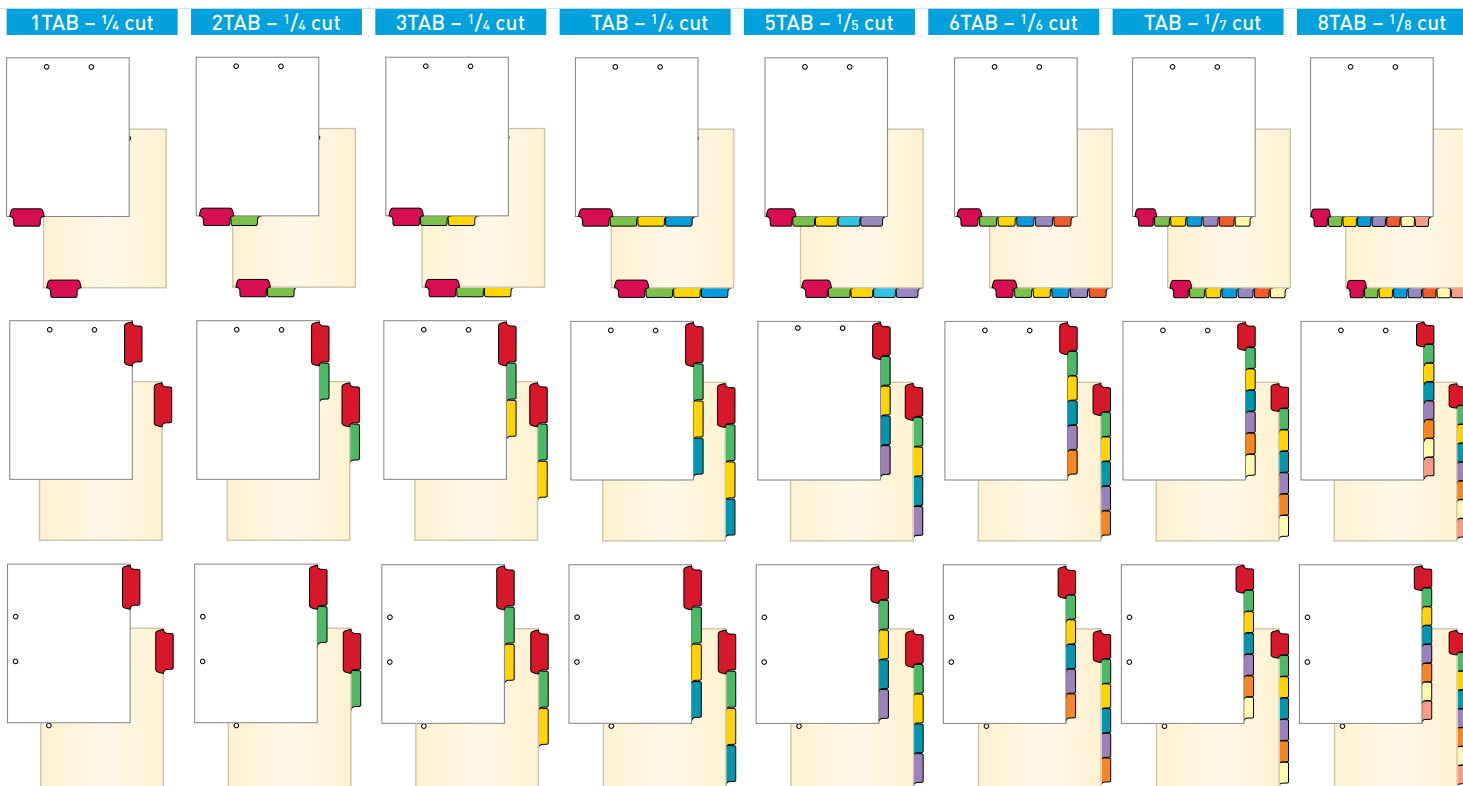

Minimum order quantity is a set of 50 indexes.

Indexes – Index Labels

Jeter Bottom and Side Tab Index Labels

Alignment marks on Jeter file dividers allow for two basic index placements, bottom tab and side tab. Index labels are available in a rainbow of colors and come with a protective Mylar covering. Choose from our solid color] indexes and/or a variety of labels with printed categories. Labels can also be custom printed to meet your requirements. To review Standard Manila dividers used for label indexing, refer to page 21.

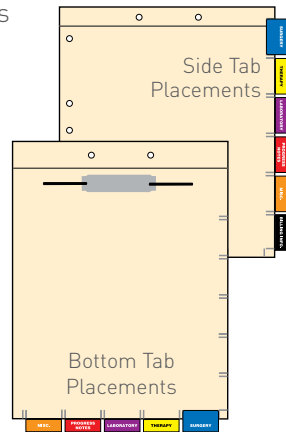

Jeter Series 1635 Solid Color Indexes

Use Jeter 1635 Series index labels and Jeter dividers to separate and classify records. We have a variety of index labels to create unique color-coded classifications – choose from solid colors or printed categories.

MODEL NO.	COLOR
1635-001	Yellow
1635-002	Light Blue
1635-003	Green
1635-004	White
1635-005	Pink
1635-033	Dark Blue
1635-034	Orange
1635-035	Red

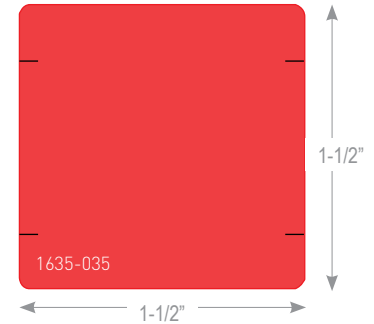

Jeter Series 1635 Printed Index Labels

- These Labels are printed in a variety of categories.
- For use with Jeter dividers.
- Index labels can be custom-printed.

MODEL NO.	PRODUCT
See Chart	1635 Printed Index Labels

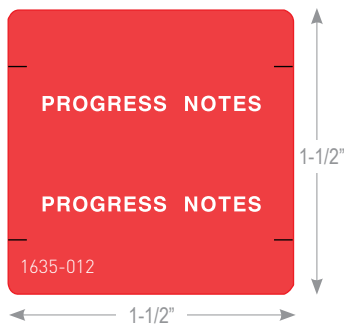

ORIGINAL STOCK ITEMS

MODEL NO.	COLOR	CATEGORY
1635-008	Dark Brown	CORRESPONDENCE
1635-009	Pink	EKG
1635-010	Purple	LABORATORY
1635-011	Orange	MISCELLANEOUS
1635-012	Red	PROGRESS NOTES
1635-013	Dark Blue	REFERRAL CONSULTATION
1635-014	Light Green	X-RAY
1635-021	Light Green	INSURANCE
1635-023	Yellow	HOSPITAL
1635-026	Aqua	HISTORY/PHYSICAL
1635-027	Pink	OPERATIVE & PATH REPORT
1635-037	Yellow	ADDITIONAL RECORDS
1635-043	Pink	ASSESSMENTS
1635-048	Black	BODILY INJURY
1635-063	Gold	ENDOSCOPY
1635-065	Light Blue	EVALUATION
1635-069	Dark Blue	FINANCIAL STATEMENTS
1635-073	White	HOME HEALTH
1635-075	Dark Blue	HOSPITAL RECORDS

NEW STOCK ITEMS

MODEL NO.	COLOR	CATEGORY
1635-108	Orange	OPERATIVE NOTES
1635-111	Dark Blue	OUTPATIENT TEST
1635-116	Yellow	PATIENT REGISTRATION
1635-123	Light Blue	PRESCRIPTIONS
1635-125	Red	PROCEDURE LIST
1635-147	Teal	X-RAY/EKG
1635-150	Pink	MRI/SCAN
1635-151	Teal	DISCIPLINE
1635-153	Fl. Pink	HIPAA

AMES Standard Filebacks

An economical way to add charts and reports to existing files.

- Overall size: 8-3/4" x 11-1/4".
- Made of durable 11 point manila stock.
- Factory-attached 2" bonded fastener.

MODEL NO.	LBS./BOX	QUANTITY
FLB-ST	40 lbs.	box of 500

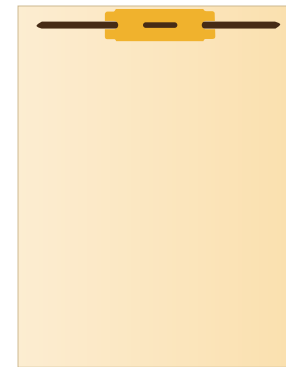

To Order Custom Filebacks

with scored wings, laminated tabs, and more, call

1-888-466-8228.

Indexes – Custom & Filebacks

Indexes



INDEX A
8 1/2" w x 11 1/2" h
 90# White
 90# Manila
Fasteners N/A

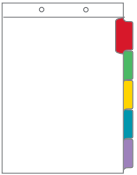

INDEX B
9" w x 11" h
 90# White
 90# Manila
Fasteners N/A

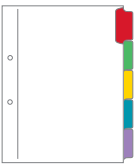

INDEX C
9" w x 11" h
 90# White
 90# Manila
Fasteners N/A

Bottom Tabs

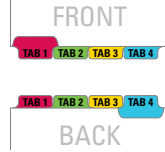

Top Hinge A, D Print Style A

- Same Print, both sides (standard)
- Print front only
- No print on Tabs

Side Tabs



Top Hinge B, E Print Style B

- Same Print, both sides (standard)
- Print front only
- No print on Tabs



Side Hinge C, F, Duotab Print Style C

- Same Print, both sides (standard)
- Print front only
- No print on Tabs

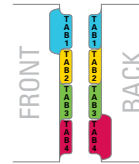

Print Style D

- Same Print, both sides (standard)
- Print front only
- No print on Tabs

Tab Size

- 1/2" Standard Index
 - 3/8" Standard Fileback
 - 1/4" Special
- From top of page to top of tab

Tab Copy

Position	Text	Color/No.
SAMPLE	Correspondence	Blue/MY425
1		
2		
3		
4		
5		
6		
7		
8		
9		
10		
11		
12		

Special Instructions:

Filebacks



FILEBACK D
8 1/2" w x 12 1/2" h
1" hinge
110# Manila
 No Fasteners
 2" Fastener

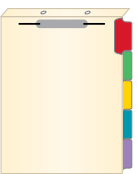

FILEBACK E
9" w x 12" h
1" hinge
110# Manila
 No Fasteners
 2" Fastener

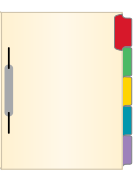

FILEBACK F
10" w x 11" h
1" hinge
110# Manila
 No Fasteners
 2" Fastener

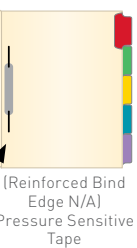

FILEBACK DUOTAB
10" w x 11" h
1" hinge
110# Manila
 No Fasteners
 2" Fastener (front & back)

(Reinforced Bind Edge N/A)
Pressure Sensitive Tape

Please indicate if you would like the fastener installed in another position than shown above.

Quantity

No. of Tabs	No. of Sets	Total Tabs

Cut Letter size Legal size

Collate Tabs into Sets?

Install Tabs into Folders?

Bind Edge Reinforcement

Yes (standard) No Reinforcement

Drilling

- Indexes: 2 holes (5/16")
- Filebacks: 2 slots (1/4")
- 2 3/4" centers, standard
- Special: _____

Printing

Font: **Helvetica Bold** (standard)
Style: ALL CAPS Initial Caps
Body Print:
 Body Print – PDF Provided
 Dealer Reorder Information:

NOTE: If no selection is made, your order will be produced using the "Standard" choice unless a sample is provided, which we will match exactly.



To order call **1-888-466-8228** or email **csquotes@tab.com**

Tel **1.888.466.8228**

Folder Accessories - Fasteners

Need to permanently attach documents to your folder?

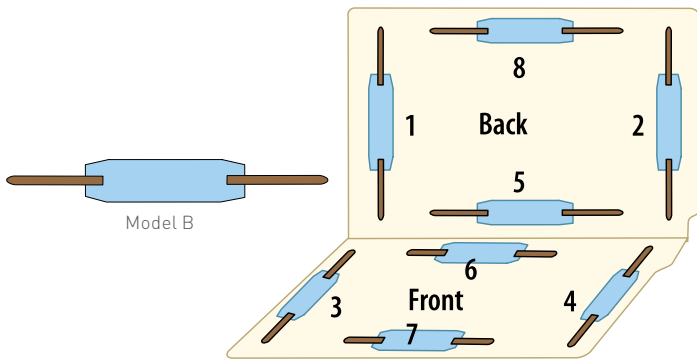

TAB Fasteners

Use these fasteners to convert your plain manila folder to a fastener folder quickly and permanently! From a simple self adhesive fastener, to a twin prong, or use a Docuclip fastener. Docuclips permit you to save time allowing you to interfile without removing pages.

FACTORY INSTALLED

MODEL NO.	DESCRIPTION	QUANTITY
B	2" Bonded Fastener	\$ 0.33/each

SELF INSTALLED

MODEL NO.	DESCRIPTION	QUANTITY
1108-00	2" Self Adhesive	box of 100



TAB Fabrene Patch

The perfect way for organizing one-hole punched papers into file folders. Combine the pin fastener with the fabrene patch to create the sturdiest holder. The fabrene patch and pin fastener can be ordered in rolls of 200 or TAB can install them for you.

MODEL NO.	DESCRIPTION	DIMENSIONS	QUANTITY
F1330	Patch	2" x 2"	200 per roll
F1331	Pin	1.5"	200 per box
F1330-IN	Flap Patch Factory Installed		
F1332-NF	No Flap Patch Factory Installed		



AMES Bonded Fasteners

Enamel coated steel construction secured by tear-resistant non-woven fabric on an easy-to-install pressure-sensitive white tag base.

- Base size: 1-1/2" x 8-1/2"
- Choose from 1" (1L) or 2" (2L) prong capacities.

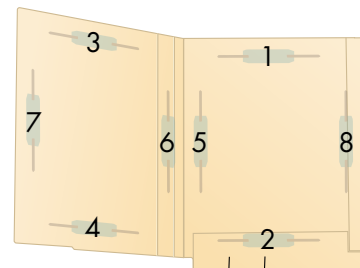

MODEL NO.	DESCRIPTION	LBS./BOX	QUANTITY
FAS-PERM-1L	1" prong	8 lbs.	box of 500
FAS-PERM-2L	2" prong	8 lbs.	box of 500

Folder Accessories - Fasteners

TAB 2-Prong DocuClip

This unique plastic fastener is an alternative to three-ring binders for active or inactive records. An ideal alternative when converting documents from bulky binders into a pressboard expansion folder!

This fastener has a self-adhesive back allowing for easy insertion into any file folder. It's flexible, three piece design features legs that are easily removed so documents can be inserted, removed or copied without disturbing preceding pages.

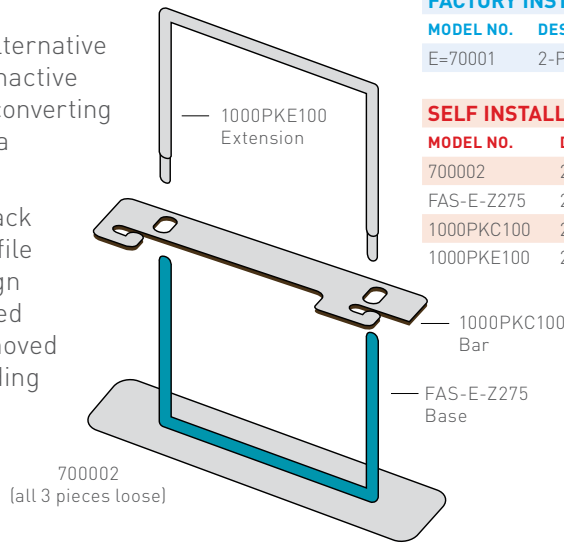

FACTORY INSTALLED

MODEL NO.	DESCRIPTION	QUANTITY
E=70001	2-Prong Docuclip	box of 100

SELF INSTALLED

MODEL NO.	DESCRIPTION	QUANTITY
700002	2-Prong Docuclip – complete - 3 pieces	box of 100
FAS-E-Z275	2-Prong Docu Base Compressor	box of 100
1000PKC100	2-Prong Docu Bar	box of 100
1000PKE100	2-Prong Docu Extension	box of 100

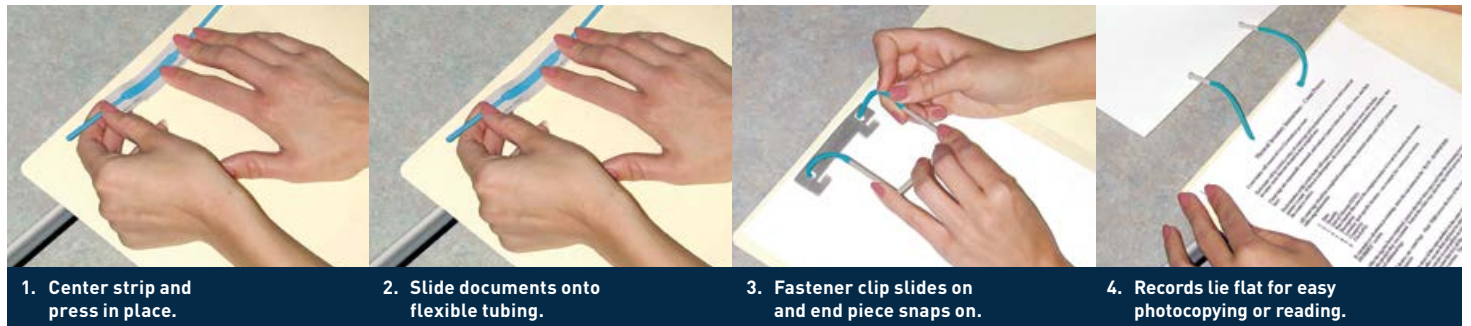

AMES Attach-Yourself Easiclip Fasteners

Attach Easiclips to folders, filebacks, report covers – anywhere you need to secure documents.

- Available in standard (3-3/4") or large size (8-1/2") base.
- Sets contain all three component pieces (see right):
 - A. Extension piece.
 - B. Compressor bar.
 - C. Tubing and base with pressure sensitive self adhesive.
- Components also available separately as "Spare Parts".

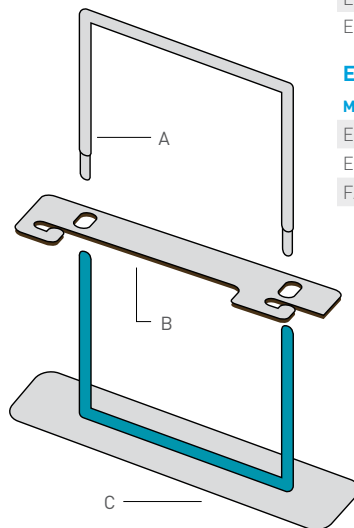

Easiclip Sets

MODEL NO.	DESCRIPTION	LBS./BOX	QUANTITY
EZ275RBIC	Standard base set, 100-pack	3 lbs.	box of 100
EZ275RBIM	Standard base set, economy pack	27 lbs.	box of 1000

Easiclip Spare Parts

MODEL NO.	DESCRIPTION	LBS./BOX	QUANTITY
EZ-EXT-275	Extension pieces	2 lbs.	box of 250
EZ-CMP-275	Compressor bars	2 lbs.	box of 250
FAS-E-Z275A	Standard bases with tubing	8 lbs.	box of 1000

Folder Accessories – Vinyl Pockets

TAB Clear Vinyl Pockets

Small documents can be organized and secured within a file using pockets. Made from vinyl each has a self adhesive back to firmly attach the pocket to the folder.

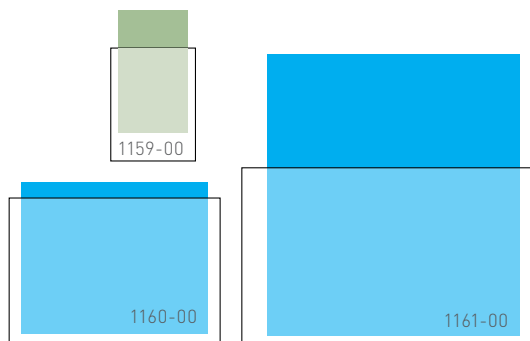

SELF INSTALLED

MODEL NO.	DESCRIPTION	WEIGHT	QUANTITY
1159-00	Vinyl 2 1/4" w x 3 1/8" h	5 lbs.	box of 100
1160-00	Vinyl 6" w x 4" h	13 lbs.	box of 100
1161-00	Vinyl 8 3/4" w x 5" h	21 lbs.	box of 100

All dimensions are inside dimensions.

AMES Polyethylene Pocket Attachments

- Made of clear, non-yellowing, heavy-duty 5-gauge polyethylene with pressure-sensitive adhesive backing.

MODEL NO.	DESCRIPTION	INTERIOR DIMENSIONS	LBS./BOX	QUANTITY
13-411L	Open side	6-1/2" x 4-1/4"	15 lbs.	box of 1000

*Opens on long edge.



Jeter Pressure-Sensitive Pockets

Jeter offers many different sizes of pressure-sensitive pockets. You can add pockets wherever and whenever required. These pockets are great for small media, such as ID cards, microfiche and lab reports. Pockets are durable, yet thin enough to not add bulk to your file folders. Open side of pocket is first dimension.

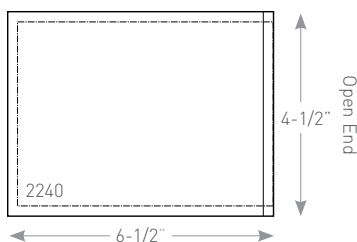

Polyethylene Pockets

Self-adhesive or factory-installed.

MODEL NO.	DESCRIPTION	DIMENSIONS H x W	QUANTITY
F1346	Credit Card Size	3 1/8" x 2 1/4"	box of 1000
F1347	Microfiche Size	4 3/8" x 6 1/2"	box of 1000

Poly Pockets - Clear Front and Back Panel

MODEL NO.	SIZE	QTY./BOX	WT./BOX
2220	3-3/4" W x 5" H	100	1 Lbs.
2240	4-1/2" W x 6-1/2" H	100	2 Lbs.
2250	9-1/4" W x 6" H	100	3 Lbs.

Vinyl Pockets - Non Glare Frosted Front Panel

1161-00 (formally 2260V)	9" W x 5-3/4" H	100	4 Lbs.
--------------------------	-----------------	-----	--------

Folder Accessories – Dividers

File Folder Dividers

Separate contents within your files easily with these 14 pt. white file folder dividers. These dividers come with a self-adhesive strip on the bottom edge for attaching at the fold and can be factory installed into your folders or purchased separately.

MODEL NO.	DESCRIPTION	DEIMENSIONS H x W	QUANTITY
F1421	14 pt. Letter divider, self-adhesive	9 3/8" x 11"	box of 500
F1423	14 pt. Metric divider, self-adhesive	9 3/8" x 11 3/4"	box of 500
F1422	14 pt. Legal divider, self-adhesive	9 3/8" x 14"	box of 500
F1421-IN	14 pt. Letter, one divider, factory installed*	9 3/8" x 11"	
F1423-IN	14 pt. Metric, one divider, factory installed*	9 3/8" x 11 3/4"	
F1422-IN	14 pt. Legal, one divider, factory installed*	9 3/8" x 14"	

*Folders must be ordered separately.

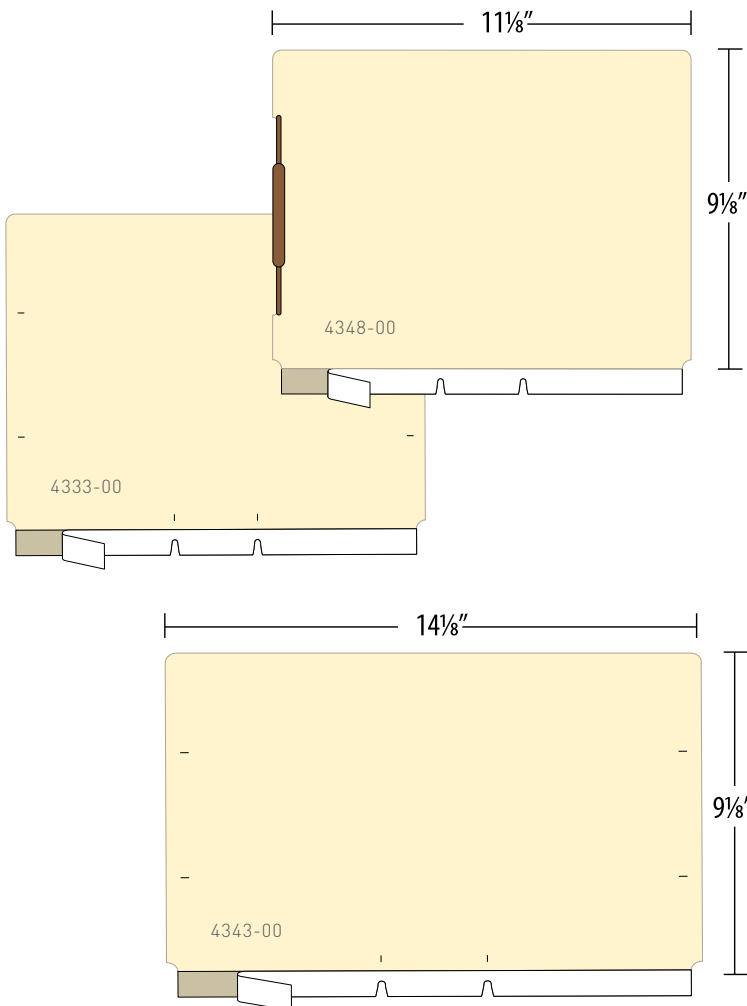

Pressure-Sensitive Dividers

Made of 11 pt. Manila, convert files to multiple classifications.

Letter

FACTORY INSTALLED

MODEL NO.	DESCRIPTION	QUANTITY
N=4333-00	9 1/8" h x 11 1/8" w	box of 100
O=4348-00	9 1/8" h x 11 1/8" w with 1" twin prong fastener	box of 100

SELF INSTALLED

MODEL NO.	DESCRIPTION	QUANTITY
4333-00	9 1/8" h x 11 1/8" w	box of 100
4348-00	9 1/8" h x 11 1/8" w with 1" twin prong fastener	box of 100

Legal

FACTORY INSTALLED

CALL FOR QUOTE.

SELF INSTALLED

MODEL NO.	DESCRIPTION	QUANTITY
4343-00	9 1/8" h x 14 1/8" w	box of 100
4345-00	11 1/2" h x 15 3/8" w	box of 200

Folder Accessories – Dividers

Jeter File Dividers

Jeter file dividers separate the internal contents of file folders. Use of these dividers allows you to keep key information segregated for convenient access as files grow. You may select dividers that accept an extra fastener, which allows a section of materials to be removed without disrupting other documents within the folder.

The dividers listed have embossed position marks around their parameters to receive Jeter's standard indexing labels to create actual tabs.

Letter

Top Hinge 8-1/2" W x 12-1/4" H, 11 pt., Single Ply

MODEL NO.	FASTENER POSITION	BOX/CARTON	CARTON WT.
J1635	N/A	100/1000	4 Lbs.
J1636	1	100/500	5 Lbs.

Side Hinge 9-1/2" W x 11" H, 11 pt., Single Ply

MODEL NO.	FASTENER POSITION	BOX/CARTON	CARTON WT.
J1637	5	100/500	5 Lbs.

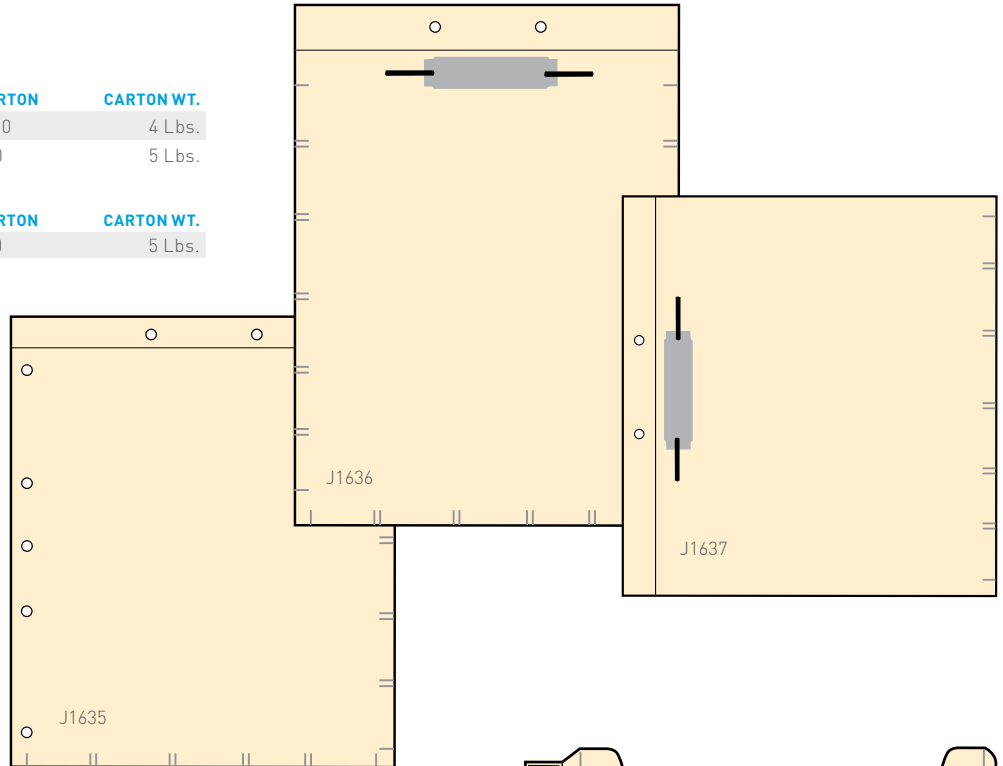

Jeter Pressure-Sensitive Adhesive File Dividers

This divider is equipped with pressure-sensitive adhesive for easy attachment to any top code or end code file folder. Order letter size dividers with or without fasteners. Dividers are die-cut for use with twin prong fasteners.

Letter 9-1/2" W x 11-1/8" H, 11 pt., Single Ply

MODEL NO.	FASTENER POSITION	BOX/CARTON	CARTON WT.
J13011	N/A	100/1000	4 Lbs.
J13011-TP-1	TP-1	100/1000	4 Lbs.

Legal 9-3/8" W x 14" H, 11 pt., Single Ply

MODEL NO.	FASTENER POSITION	BOX/CARTON	CARTON WT.
J13012	N/A	100/1000	4 Lbs.

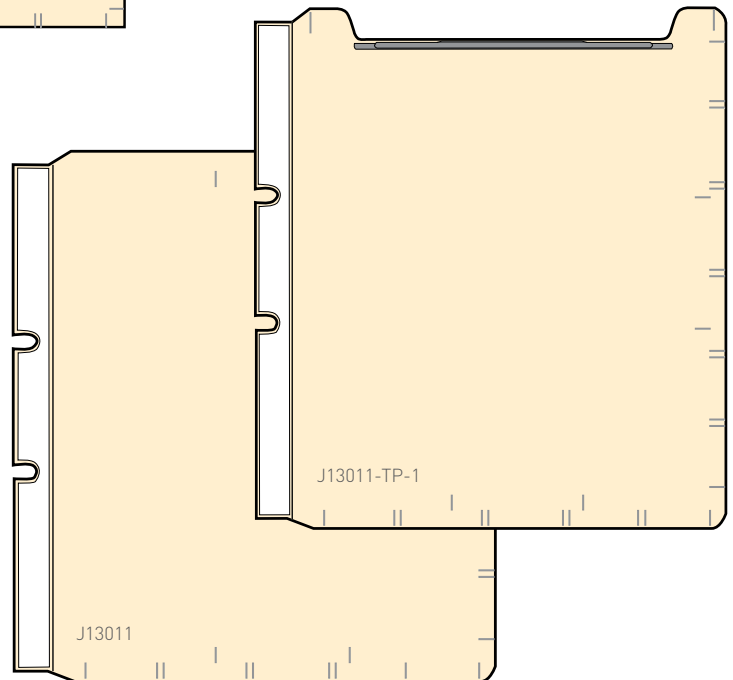

Folders Accessories – Tabs

Top/Side Conversion

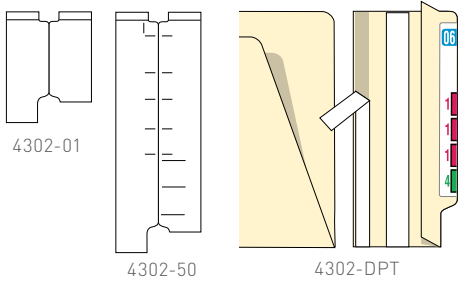

Convert-a-Tab

Change your top tab folder to an end tab folder using this self adhesive heavy white label stock. Remove the backing sheet, align the crease with the top and bottom of your folder edge and wrap the convert-a-tab over the edge.

Letter

SELF INSTALLED

MODEL NO.	DESCRIPTION	QUANTITY
4302-01	4" h white tag	box of 250
4302-DPT	9 $\frac{3}{8}$ " h Manila Double Ply	box of 100

TAB will no longer offer/quote the attaching of Compucolor or Filepak labels to the 4302-50 or 4302-01 convert-a-tabs (white). Both these models will continue to be stock items with immediate availability.

Jeter Create-A-Tab

If you need to change your top tab folders to end tab, Create-A-Tabs provide a unique solution. Jeter offers two styles of Create-A-Tabs, which allow you to attach a pressure-sensitive tab to the end of your top tab file folder. Create-A-Tabs are stock items. They have a crack-and-peel backer, which makes them easy to apply to file folders. Create-A-Tabs will adhere securely to most file folder surfaces, depending upon the condition of the file folder.

MODEL NO.	DESCRIPTION	QUANTITY
1631	Jeter Create-A-Tab Pressure-sensitive tab that attaches to a top tab, drawer style folder to create an end code folder.	pack of 200
1632	Jeter Create-A-Tab II This larger Create-A-Tab has a tab shape that matches our Super Coder folders	pack of 200

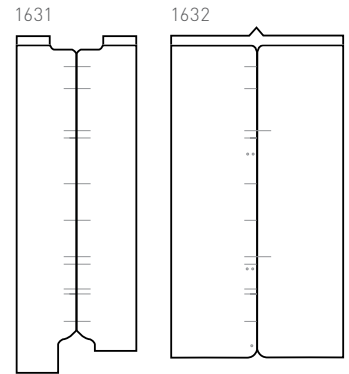

Folder Accessories – Repair and Storage

AMES Repair and Reinforcement Strips

AMES Repair and Reinforcement Strips allow you to reuse and extend the life of your folders.

- Made of clear, non-yellowing polyester.
- Permanent adhesive with split coated paper backing.
- Individually sheeted and shrink-wrapped in packages.

MODEL NO.	SIZE	LBS./ROLL	QUANTITY
L-A-RE-POLYS	2" x 11"	3 lbs.	pack of 500
L-A-RE-POLYS3	3" x 11"	4 lbs.	pack of 500



Jeter Archival Cartons

These great storage cartons are the same ones in which we ship most of our file folders. Jeter archival cartons are stocked in letter and legal sizes, 5 per package.

Letter 16-3/4" W x 10-1/2" H, 11 x 12-3/4" H

MODEL NO.	COLOR	BOX/CARTON	CARTON WT.
J0500	Brown	5	11 Lbs.

Legal 16-3/4" W x 10-1/2" H, 11 x 15-5/8" H

MODEL NO.	COLOR	BOX/CARTON	CARTON WT.
J0501	Brown	5	12 Lbs.

Note: Shipped in oversized cartons; premium freight charges will apply.



CN1125 & CN1155

Storage Boxes for End Tab Folders

Heavy duty, recycled fibreboard cartons provide excellent protection and long lasting durability for inactive files. Their sturdy construction allows 2-high stacking and velcro closures keep boxes closed securely. Drop-front format gives you instant access without lifting boxes. Order in multiples of 10.

MODEL NO.	DESCRIPTION	DEIMENSIONS H x W x D	QUANTITY
CN1125	Carbon Neutral Legal end tab storage boxes	16" x 13 1/2" x 10"	box of 10
CN1155	Carbon Neutral Letter/Metric end tab storage boxes	13 1/2" x 13 1/2" x 10"	box of 10
F1000	White Legal end tab storage boxes	16" x 13 1/2" x 10"	box of 10
F1025	White Letter/Metric end tab storage boxes	13 1/2" x 13 1/2" x 10"	box of 10

1165-01
1165-02



F1000



1165

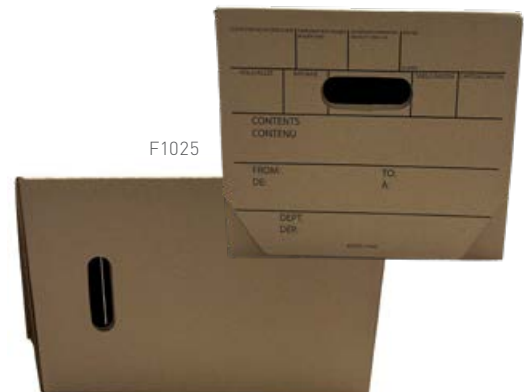

F1025

Custom File Folders Options – Tabs and Pockets

Converting Drawer File Folders Into Lateral File Folders

Convert to lateral filing while protecting your investment in drawer file folders - just add conversion tabs. They have printed tick marks on the back to guide placement of color control labels. The conversion tabs are slit for placement on a fastener.

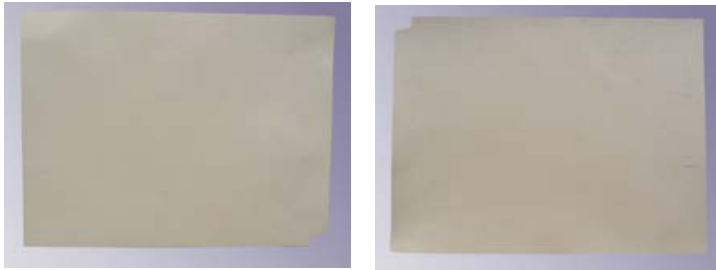

GBS Conversion Tabs with Fastener Slots

MODEL NO.	DESCRIPTION	CARTON QTY	CARTON WT.
8631	11 Pt. Letter Conversion Tabs, Fastener Slots	100	5 Lbs.
8635	14 Pt. Letter Conversion Tabs, Fastener Slots	750	42 Lbs.

TAB Manila Pockets

Want to keep small items from falling out of your file? Add a manila pocket in one or several locations. From credit cards to letter size documents these factory installed pockets can improve your information process.

FACTORY INSTALLED

MODEL NO.	DESCRIPTION	QUANTITY
F	3E Manila 2 1/2" w x 3 1/8" h	box of 100
G	6E Manila 6 1/4" w x 4 1/8" h	box of 100
H	8E Manila 8 3/8" w x 4 3/4" h	box of 100
J	9E Manila 9 3/8" w x 4 3/4" h	box of 100
K	Vinyl 2 1/4" w x 3 1/8" h [1159-00]	box of 100
L	Vinyl 6" w x 4" h [1160-00]	box of 100
M	Vinyl 8 1/2" w x 5" h [1161-00]	box of 100

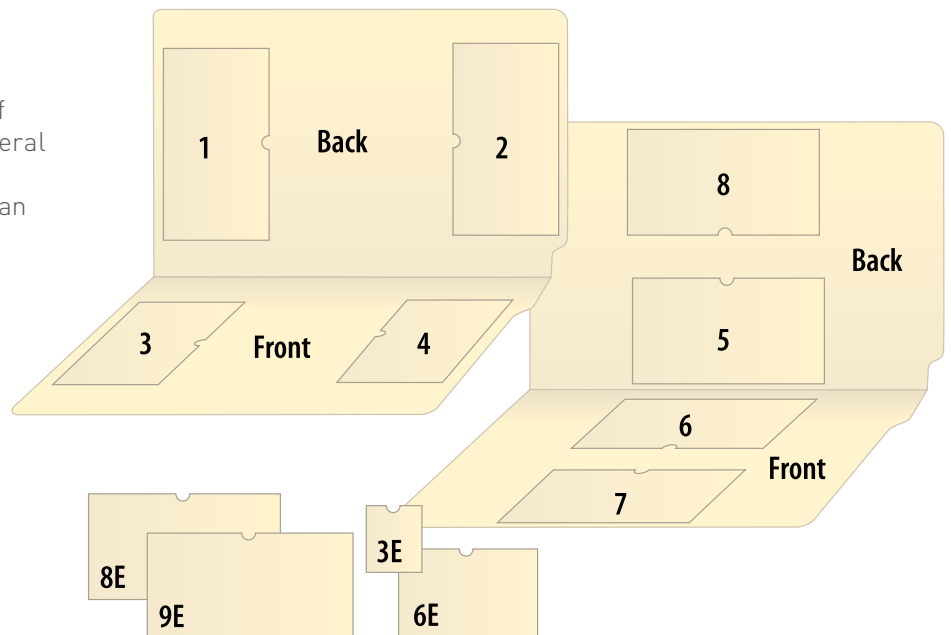

GBS The Converter with Self Adhesive Strips

MODEL NO.	DESCRIPTION	CARTON QTY	CARTON WT.
8669	11 Pt. Letter Conversion Tabs, 7 3/8" H x 9" W [2], Self-Adhesive Strips	100	3 Lbs.

Custom File Folders Options – Strip Labels and Printing



Factory Installed GBS Computer Generated Strip Labels

Whether you require file folders pre numbered in sequence, or you are sending data files, GBS can print and apply full strip, Mylar laminated labels to the folder of your choice. We provide the label design, label proofing and label application. When you have a lot of folders to color code, this service will save countless hours. Your new folders will arrive in the desired sequence. Save time and money with our Factory Installed Computer Generated Strip Label Service.

TAB Custom Dividers

Keep information in organized groups within your folder with installed dividers. Optional twin prong fastener allows for attaching documents on either side of the divider.

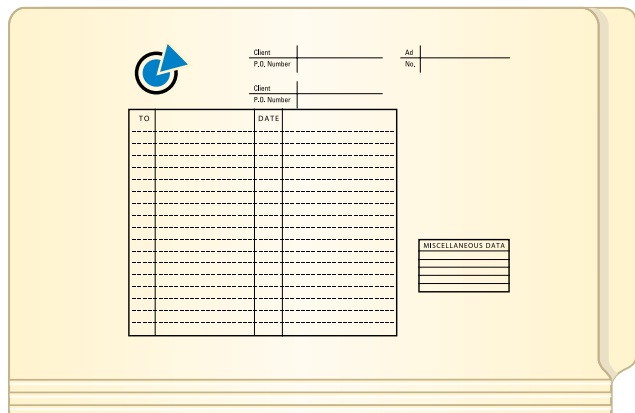
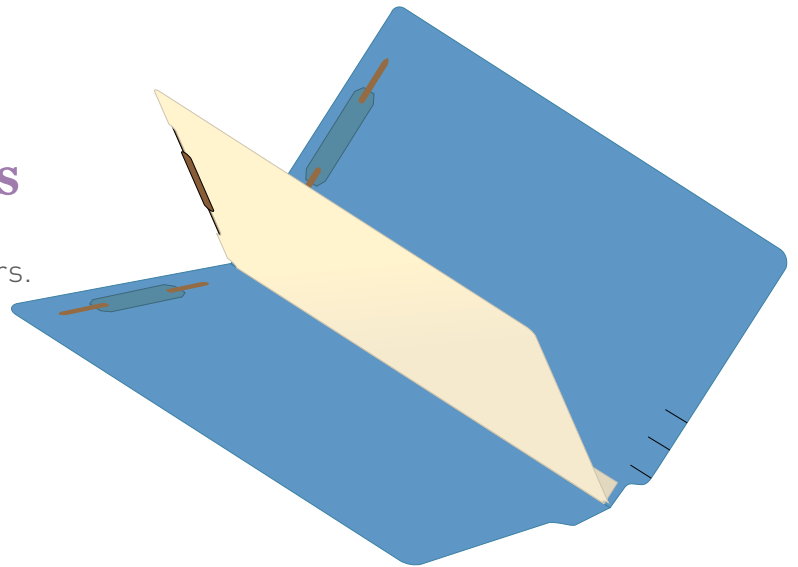

Printing

Outside Front, Inside Front, Inside Back, Outside Back. 500 or 100,000. One Color. Two colors. Your artwork. Our artwork. TAB can print whatever you want wherever you want it.

FACTORY INSTALLED

MODEL NO.	DESCRIPTION	QUANTITY
P	Printing One Color One Panel	box of 100
Q	Printing Numbering on Folder	box of 100
R	Printing Two Colors One Panel	box of 100

500 piece minimum for printing.

Outguides – Vinyl Outguides and Dividers

Vinyl Outguides

Prevent lost files, lost information and search time by using outguides to identify folders removed from the system. Use a charge out slip to identify who has the file. Included is space to file trailing documents, allowing effective interfiling when the folder returns to file. Eliminate stacks of documents at your records desk to be filed.

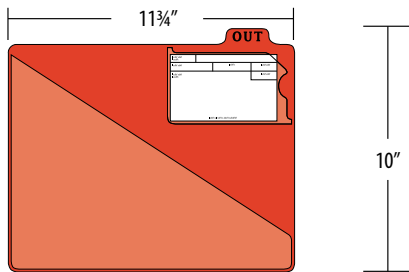
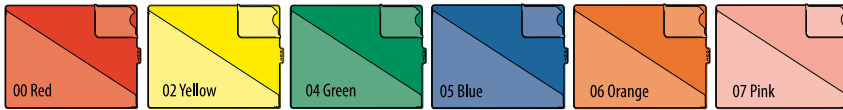

Letter 10" High x 11³/₄" Wide

MODEL NO.	DESCRIPTION	QUANTITY
4370-00	Outguide	box of 50

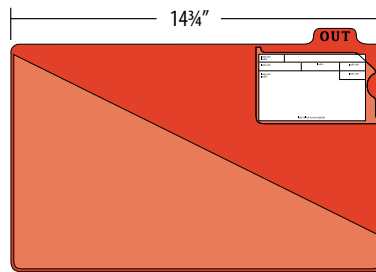

Legal 10" High x 14³/₄" Wide

MODEL NO.	DESCRIPTION	QUANTITY
4388-00	Outguide	box of 50

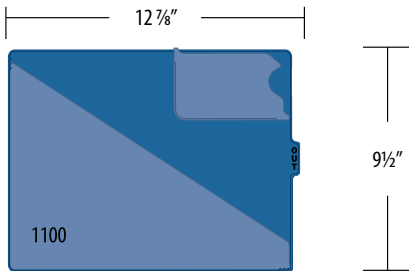

Letter 9¹/₂" High x 12³/₄" Wide

MODEL NO.	DESCRIPTION	QUANTITY
1100-**	Middle Tab	box of 50

Replace ** with a color number

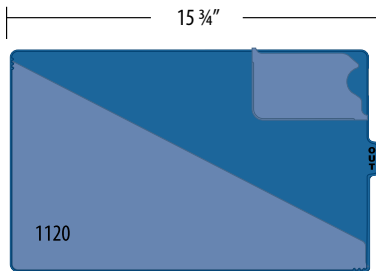

Legal 9¹/₂" High x 15³/₄" Wide

MODEL NO.	DESCRIPTION	QUANTITY
1120-**	Middle Tab	box of 50

Replace ** with a color number

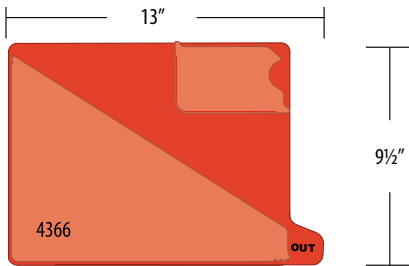

Letter 9¹/₂" High x 13" Wide

MODEL NO.	DESCRIPTION	QUANTITY
4366-**	Lower Tab	box of 50

Replace ** with a color number

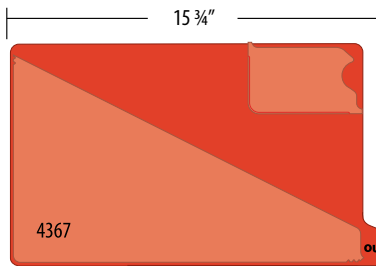

Legal 9¹/₂" High x 15³/₄" Wide

MODEL NO.	DESCRIPTION	QUANTITY
4367-**	Lower Tab	box of 50

Replace ** with a color number

Jeter File Dividers

Jeter outguides are a great way to control documents when removed from the file. A charge-out form on the outguide names the borrower of the record and notes the date the record left the file area. The outguide clearly indicates where to return file folders that have been removed from the system, so refiling is both fast and accurate, saving valuable time.

Most Jeter out-guide folders contain a pocket to hold documents. Once a file folder is returned to the system, the documents can be transferred directly into the permanent folder. Jeter outguide folders are available in a variety of colors. These colors can be used to signify certain weeks of the month, specific departments or whatever meets your organization's needs.

MODEL NO.	COLOR	QTY./CARTON	WT./CARTON.
J6480	N/A	1000/pkg.	2 Lbs.

Outguides – Charge-Out

Charge-out Control of Files

Keeping track of borrowed file folders can prevent lost files and lost time. Vinyl Charge-out Guides use a Charge-out Slip to list the name of the borrower, date the file was removed and the follow-up date. The Vinyl Charge-out Guide also has an additional pocket for filing any material which may come in while the borrowed file is out. The Charge-out Paper Folder also accommodates incoming materials while the folder is out and it is printed to record the name of the borrower and the date the file was removed. Charge-out Cards are also printed to record the pertinent information.

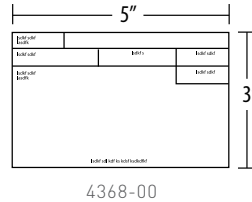

4368-00

Charge-Out Slips

MODEL NO.	DESCRIPTION	QUANTITY
4368-00	Charge-Out Slips	box of 1000



Vinyl Charge-out Guides

MODEL NO.	DESCRIPTION	DIMENSIONS H x W	QUANTITY
For side tab folders			
F1963-1	Letter, red, centre tab	9 1/2" x 12 3/4"	box of 100
F1965-1	Legal, red, centre tab	9 1/2" x 15 3/4"	box of 100



Charge-out Paper Folder (Bilingual)



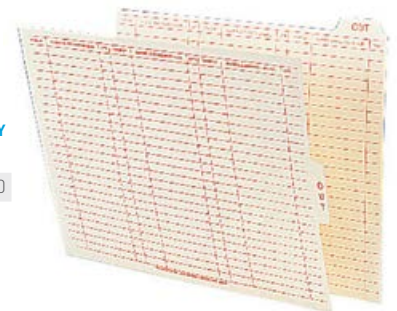

MODEL NO.	DESCRIPTION	DIMENSIONS H x W	QUANTITY
For side tab folders only			
F1952-BL	Legal, red, centre tab	9 1/2" x 16 1/8"	box of 100

Charge-out Cards (Available in English only)

MODEL NO.	DESCRIPTION	DIMENSIONS H x W	QUANTITY
For side tab folders			
4308-75	18 pt. Letter, manila, centre tab	9 1/2" x 12 3/4"	box of 100

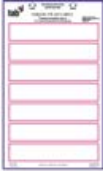
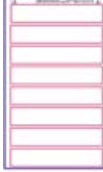

Purchase -CLCOM Labels to use with TABQUIK.com software.

	Label Size 7.75" x 1.66"		Label Size 7.75" x 1.66"		Label Size 7.75" x 1.66"		Label Size 7.75" x 1.66" (Inkjet)		Label Size 7.75" x 1.66" (Laser)
7 Labels/Sheet 6304-00 (Inkjet) 6304-00-CLCOM	Labels/Box 1750 1750	8 Labels/Sheet 6307-00 (Inkjet) 6307-00-CLCOM	Labels/Box 400 400	5 Labels/Sheet 6321-00 (Laser) 6321-00-CLCOM 6324-00 (Inkjet) 6324-00-CLCOM	Labels/Box 1500 1500 500 500	6 Labels/Sheet 6324-HA (Inkjet) 6324-HA-CLCOM 6324-HA50 6324-HA50-CLCOM	Labels/Box 1800 1800 300 300	6 Labels/Sheet 6321-HA 6321-HA-CLCOM 6321-HA50 6321-HA50-CLCOM	Labels/Box 1800 1800 300 300
	Label Size 8" x 1.5"		Label Size 4 – 8" x 1.5" and 4 – 3.87" x 1.5"		Label Size 8" x 1.5" notched		Label Size 6.75" x 1.66"		Label Size 8" x 1.5"
6 Labels/Sheet 6376-00 (Inkjet) 6376-50 (Inkjet) 6376-00-CLCOM 6376-50-CLCOM 6379-00 (Laser) 6379-50 (Laser) 6379-00-CLCOM 6379-50-CLCOM	Labels/Box 1500 300 1500 300 1500 300 1500 300	4 sets of 2 Labels/Sheet 6380-00 (Laser) 6380-00-CLCOM	Sheets/Box 250 250	6 Labels/Sheet 6378-00 (Inkjet) 6378-00-CLCOM	Labels/Box 1500 1500	6 Labels/Sheet 6443-00 (Laser) 6443-00-CLCOM	Labels/Box 1800 1800	6 Labels/Sheet 6408-00 (Inkjet) 6408-50 (Inkjet) 6408-00-CLCOM 6408-50-CLCOM 6384-00 (Laser) 6384-50 (Laser) 6384-00-CLCOM 6384-50-CLCOM	Labels/Box 1500 300 1500 300 1500 300 1500 300
	Label Size 8" x 1-7/16"		Label Size 5.5" x 1.66"		Label Size 7.75" x 1.66" #10 Envelope Size		Label Size 4" x 1.5" Perfed Middle		Label Size 8.75" x 1.875"
7 Labels/Sheet 6412-00 (Laser) 6412-00-CLCOM (Laser) 6413-00 (Inkjet) 6413-00-CLCOM	Labels/Box 1008 1008 1008 1008	6 Labels/Sheet 6446-00 (Inkjet) 6446-00-CLCOM 6447-00 (Laser) 6447-00-CLCOM	Labels/Box 300 300 300 300	2 Labels 6405-00-CLCOM 6410-00-CLCOM	Labels/Box 200 200	14 Labels/Sheet 6414-00 (Laser)	Labels/Box 100	4 Labels/Sheet 6444-00 (Inkjet) 6445-00 (Laser) 6445-00-CLCOM	Labels/Box 1000 1000 1000

Additional Labels that are Available but Templates Not Shown on this Page:

6304-20	7 Labels/sheet	6.25" x 1.66"	1750 Labels/box (Inkjet)
6352-00	12 Labels/sheet	3.875" x 1.66"	3600 Labels/box (Inkjet)
6403-00	6403-00-CLCOM	12 Labels/sheet	3600 Labels/box (Laser)
6400-00	6400-00-CLCOM	4 X-ray Labels/sheet	1000 Labels/box (Inkjet)
6381-00	6381-00-CLCOM	4 Labels/sheet	1000 Labels/box (Laser)

*Note: Label models that end with -CLCOM are the required labels to order with the TABQUIK Internet Version software 6800-COM launched September 1, 2011. Please contact us for details on pricing and a demonstration of the TABQUIK.com software.

GBS NetLabels – The Converter with Self Adhesive Strips

MODEL NO.	DESCRIPTION	CARTON QTY	CARTON WT
8960CL	8" x 1 1/2" Adhesive Label, 6-Up	600	3 Lbs.
8961CL	8" x 1 1/4" Adhesive Label, 7 -Up	700	3 Lbs.
8962CL	8" x 1 1/2" Laser Adhesive Label, 6-Up	600	3 Lbs.
8964CL	8" x 2 3/8" Inkjet Conversion Label, Self-Adhesive, 4-Up, Grey Opaque Back	400	3 Lbs.
8965CL	9 1/2" x 4 1/8" Inkjet Kwik Strip, 1-Up Premium Waterfast Stock	500	3 Lbs.
8968CL	4" x 4" Inkjet Labels, Premium Waterfast Stock, 4, 8" x 1 1/2" and 4, 3/8" x 1 1/2" Per Sheet	800	3 Lbs.

Labels – Alphabetic



Alphacode

Instantly recognize files on a shelf or a desk with these self-adhesive labels. Available in boxes of 500 or sheets of 50

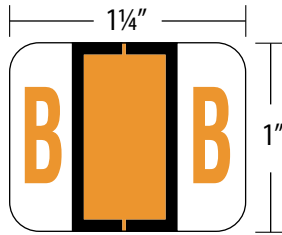

1" Color Coded Labels – Boxes

Alphacode – Replace * with desired letter A-Z

MODEL NO.	DESCRIPTION	QUANTITY
1283-*	1" High Alphabetic Color Label	box of 500
1283-50	1" High Alphabetic Color Label Complete Set – 1 box each	1 set

NOTE: If you have previously purchased the **AMES TAB® Style** labels shown below;



L-T-ALPHA-F (yellow)



L-T-ALPHA-O (yellow)



L-T-ALPHA-MC (brown)

These labels are still available. Please continue to use the old Model numbers when placing your order.

1" Color Coded Label – Sheets

Alphacode – Replace * with desired letter A-Z

MODEL NO.	DESCRIPTION	QUANTITY
1286-*	1" High Alphabetic Sheet Labels – 40 labels/sheet	1 sheet
1286-00	1" High Starter Set A to Z (3,100 labels) 100 ea. consonant; 200 ea. vowel	1 set



1278

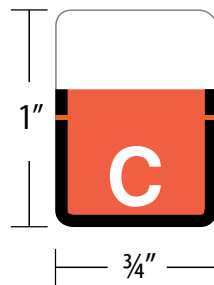

Alphabetic Labels

Instantly recognize files on a shelf or a desk with these self-adhesive labels. Available in boxes of 500.

Top Tab Alphabetic Labels

Alphacode – Replace * with desired letter A-Z

MODEL NO.	DESCRIPTION	QUANTITY
1307-*	1" High Alphabetic Color Label	box of 500
1307-50	1" High Alphabetic Color Label Complete Set A-Z	1 set

1/2" Color Coded Classification Labels

Alphacode – Replace * with desired letter A-Z

MODEL NO.	DESCRIPTION	QUANTITY
1278-*	1/2" High Alphabetic Color Label	box of 500
1278-50	1/2" High Alphabetic Color Label Complete Set – 1 box each	1 set



Labels – Alphabetic

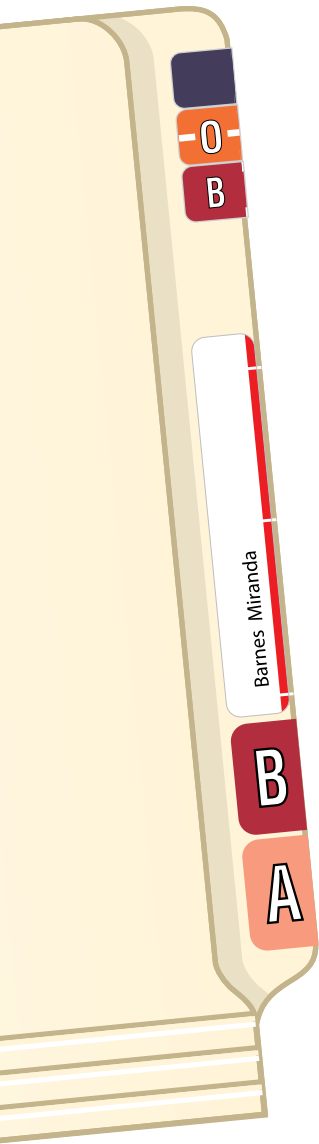

DataFile® Alphacode

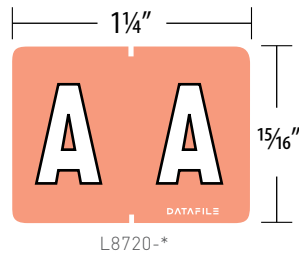

L8720-*



Full Size Color Coded Labels - Boxes

Alphacode – Replace * with desired letter A-Z

MODEL NO.	DESCRIPTION	QUANTITY
L8720-*	Alphabetic Color Label	box of 500
L8724	Alphabetic Color Label Complete Set – Box	1 set

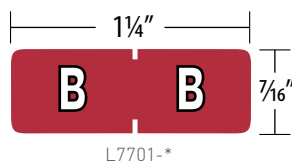

L7701-*

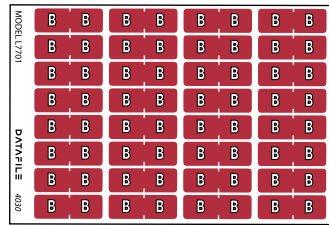

Half Size Color Coded Labels - Sheets

Alphacode – Replace * with desired letter A-Z

MODEL NO.	DESCRIPTION	QUANTITY
L7701-*	Alphabetic Color Label 32 labels/sheet, 8 sheets/package	1 pkg
L7704	Alphabetic Color Label Complete Set – Sheets	1 set



MODEL NO. PRODUCT

7501 Top Coder Alpha Book
The Alpha Series is for use with standard drawer file systems. Complete set comes in a compact three-ring binder with indexes. Includes 1,950 Alpha Codes proportioned to expected usage. Also includes 162 Year Codes and 27 each of 4 Solid Color-Codes (Red, Yellow, Blue, Green) for a total of 2,200 Color-Codes. Instructions and wall chart for color orientation are included.

7502 Refill Set
For use with above set. Includes 1,950 Alpha Code labels proportioned to expected usage.

No Year Codes, Special Codes, Binder or Index.

(see chart) Refill Pages
For use with above set. Includes 1,950 Alpha Code labels proportioned to expected usage. No Year Codes, Special Codes, Binder or Index.

Jeter Series 7500 Mylar Pages

LABEL	MODEL NO.	LABEL	MODEL NO.	LABEL	MODEL NO.
A	pages: 7510	J	pages: 7519	R	pages: 7528
B	pages: 7511	K	pages: 7520	S	pages: 7529
CL	pages: 7512	L	pages: 7521	T	pages: 7530
D	pages: 7513	M	pages: 7522	U	pages: 7531
E	pages: 7514	N	pages: 7523	V	pages: 7532
F	pages: 7515	O	pages: 7524	W	pages: 7533
G	pages: 7516	PL	pages: 7525	X	pages: 7534
H	pages: 7517	Q	pages: 7526	Y	pages: 7535
I	pages: 7518		pages: 7527	Z	pages: 7536

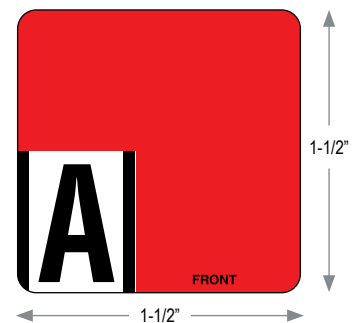

Labels – Alphabetical

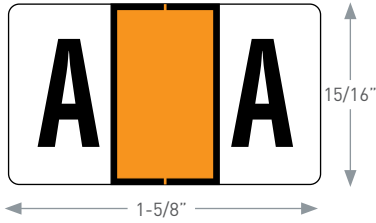

**Jeter Alpha Labels
Series 5800/7200/7100**
Mylar Pages/Rolls/Sheets

LABEL	MODEL NO.	LABEL	MODEL NO.	LABEL	MODEL NO.
	pages: 5810 rolls: 7250 sheets: 7110		pages: 5819 rolls: 7259 sheets: 7119		pages: 5828 rolls: 7268 sheets: 7128
	pages: 5811 rolls: 7251 sheets: 7111		pages: 5820 rolls: 7260 sheets: 7120		pages: 5829 rolls: 7269 sheets: 7129
	pages: 5812 rolls: 7252 sheets: 7112		pages: 5821 rolls: 7261 sheets: 7121		pages: 5830 rolls: 7270 sheets: 7130
	pages: 5813 rolls: 7253 sheets: 7113		pages: 5822 rolls: 7263 sheets: 7123		pages: 5831 rolls: 7271 sheets: 7131
	pages: 5814 rolls: 7254 sheets: 7114		pages: 5823 rolls: 7263 sheets: 7123		pages: 5832 rolls: 7272 sheets: 7132
	pages: 5815 rolls: 7255 sheets: 7115		pages: 5824† rolls: 7264† sheets: 7124†		pages: 5833 rolls: 7273 sheets: 7133
	pages: 5816 rolls: 7256 sheets: 7116		pages: 5825 rolls: 7265 sheets: 7125		pages: 5834 rolls: 7274 sheets: 7134
	pages: 5817 rolls: 7257 sheets: 7117		pages: 5826 rolls: 7266 sheets: 7126		pages: 5835 rolls: 7275 sheets: 7135
	pages: 5818 rolls: 7258 sheets: 7118		pages: 5827 rolls: 7267 sheets: 7127		pages: 5836 rolls: 7276 sheets: 7136

MODEL NO. PRODUCT

5801* Alpha Book

5801-A** Alpha Book

This three-ring binder contains 3,120 Alpha Codes proportioned to expected usage. Also includes 162 Year Codes and 27 each of 4 solid Color-Codes (Red, Yellow, Blue, Green) for a total of 3,390 Color-Codes. Complete set includes instructions and wall chart for color orientation. Also available in Series 7100 Alpha Pax and Series 7200 Alpha Rolls. * Use 5800 Series Year Code / ** Use 2500 Series Year Code

5802 Refill Set

For use with End Coder Book. Includes 3,120 Alpha Codes only. No Binder, Index, Year, or Special Codes.

(see chart) Refill Pages

Replacement pages for above. Sold by individual letter, 10 pages, 240 labels per poly bag. Three-hole punched.

7290 Alpha Roll Set

Complete set of 27 rolls, packaged in outer box to hold rolls in an orderly manner.

(see chart) Alpha Roll Labels

500 labels per roll in dispenser box.

(see chart) Alpha Sheets

This series is available only in polybag pax format. Each polybag contains 225 labels of an individual Alpha Code. No Starter Kit or Refill Kit available.



**Jeter Alpha Labels
Series 7700/8900**
Mylar Pages/Rolls

LABEL	MODEL NO.	LABEL	MODEL NO.	LABEL	MODEL NO.
	pages: 7710 rolls: 8950		pages: 7719 rolls: 8959		pages: 7728 rolls: 8968
	pages: 7711 rolls: 8951		pages: 7720 rolls: 8960		pages: 7729 rolls: 8969
	pages: 7712 rolls: 8952		pages: 7721 rolls: 8961		pages: 7730 rolls: 8970
	pages: 7713 rolls: 8953		pages: 7722 rolls: 8962		pages: 7731 rolls: 8971
	pages: 7714 rolls: 8954		pages: 7723 rolls: 8963		pages: 7732 rolls: 8972
	pages: 7715 rolls: 8955		pages: 7724 rolls: 8964		pages: 7733 rolls: 8973
	pages: 7716 rolls: 8956		pages: 7725 rolls: 8965		pages: 7734 rolls: 8974
	pages: 7717 rolls: 8957		pages: 7726 rolls: 8966		pages: 7735 rolls: 8975
	pages: 7718 rolls: 8958		pages: 7727 rolls: 8967		pages: 7736 rolls: 8976

MODEL NO. PRODUCT

7701* Double J Alpha Book

This three-ring binder contains 3,120 Alpha Codes proportioned to expected usage. Also includes 162 Year Codes, and 27 each of 4 Solid Color-Codes (Red, Yellow, Blue, Green), for a total of 3,390 Color Codes. Complete set includes instructions and wall chart for color orientation. * Use 2500 Series Year Code

7702 Double J Alpha Refill Set

For use with End Coder Book. Includes 3,120 Alpha Codes only. No Binder, Index, Year or Special Codes.

(see chart) Refill Pages

Replacement Alpha Pages for End Coder Book. Alpha labels only, 10 pages, 240 labels per polybag. Three-hole punched.

8990 Double J Alpha Roll Set

Complete set of 27 rolls, packaged in outer box to hold rolls in an orderly manner.

(see chart) Alpha Roll Labels

500 labels per roll in dispenser box.

Labels – Alphabetic

AMES Small Alpha Labels

- Size: 1-7/8" x 1".
- Polyester laminated for added durability.
- Scored to center and fold easily.
- Die cut labels with permanent adhesive and release coated paper backing.
- Packaged in self-dispensing boxes.

Individual Boxes

MODEL NO.	LBS./UNIT	QUANTITY
See right	1/2 lb.	box of 500

Label Sets (1 box of each letter)

L-A-ALPHA-ST	13 lbs.	1 set - 26 boxes
--------------	---------	------------------



MODEL NO./LETTER COLOR

L-A-ALPHA-A	AMES Red	A
L-A-ALPHA-B	AMES Grey	B
L-A-ALPHA-C	AMES Blue	C
L-A-ALPHA-D	AMES Orange	D
L-A-ALPHA-E	AMES Purple	E
L-A-ALPHA-F	Light Green	F
L-A-ALPHA-G	AMES Yellow	G
L-A-ALPHA-H	AMES Brown	H
L-A-ALPHA-I	AMES Pink	I
L-A-ALPHA-J	AMES Green	J
L-A-ALPHA-K	Violet	K
L-A-ALPHA-L	Tan	L
L-A-ALPHA-M	Salmon	M
L-A-ALPHA-N	AMES Red	N
L-A-ALPHA-O	AMES Grey	O
L-A-ALPHA-P	AMES Blue	P
L-A-ALPHA-Q	AMES Orange	Q
L-A-ALPHA-R	AMES Purple	R
L-A-ALPHA-S	Light Green	S
L-A-ALPHA-T	AMES Yellow	T
L-A-ALPHA-U	AMES Brown	U
L-A-ALPHA-V	AMES Pink	V
L-A-ALPHA-W	AMES Green	W
L-A-ALPHA-X	Violet	X
L-A-ALPHA-Y	Tan	Y
L-A-ALPHA-Z	Salmon	Z

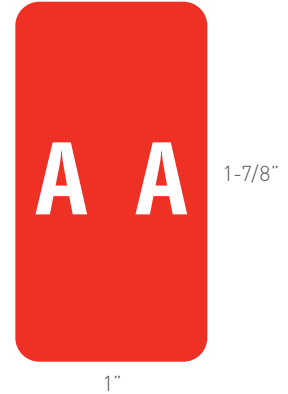

AMES Large Alpha Labels

- Size: 1-7/8" x 1-7/8".
- Made from synthetic latex stock for greater flexibility.
- Permanent adhesive and release coated paper backing.
- Packaged in self-dispensing boxes.

Individual Boxes

MODEL NO.	LBS./UNIT	QUANTITY
See right	1 lb.	box of 500

Label Sets (1 box of each letter)

L178ST	26 lbs.	1 set - 26 boxes
--------	---------	------------------



MODEL NO./LETTER COLOR

L178A	AMES Red	A
L178B	AMES Grey	B
L178C	AMES Blue	C
L178D	AMES Orange	D
L178E	AMES Purple	E
L178F	Light Green	F
L178G	AMES Yellow	G
L178H	AMES Brown	H
L178I	AMES Pink	I
L178J	AMES Green	J
L178K	Violet	K
L178L	Tan	L
L178M	Salmon	M
L178N	AMES Red	N
L178O	AMES Grey	O
L178P	AMES Blue	P
L178Q	AMES Orange	Q
L178R	AMES Purple	R
L178S	Light Green	S
L178T	AMES Yellow	T
L178U	AMES Brown	U
L178V	AMES Pink	V
L178W	AMES Green	W
L178X	Violet	X
L178Y	Tan	Y
L178Z	Salmon	Z

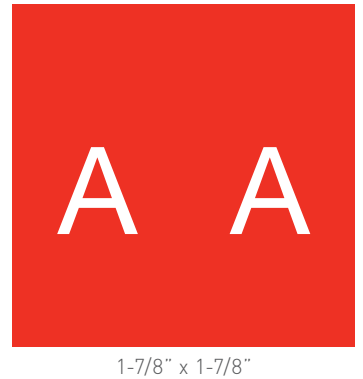

Labels – Alphabetic

COMPETITIVE MATCH LABELS

GBS – Series 2500/2800

Mylar Pages/Rolls – Jeter Match

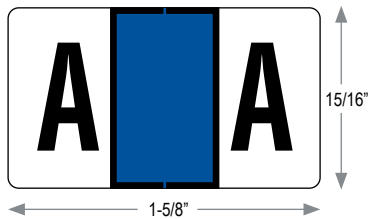

LABEL	MODEL NO.	LABEL	MODEL NO.
	pages: 2510 rolls: 2850		pages: 2524 rolls: 2864
	pages: 2511 rolls: 2851		pages: 2525 rolls: 2865
	pages: 2512 rolls: 2852		pages: 2526 rolls: 2866
	pages: 2513 rolls: 2853		pages: 2527 rolls: 2867
	pages: 2514 rolls: 2854		pages: 2528 rolls: 2868
	pages: 2515 rolls: 2855		pages: 2529 rolls: 2869
	pages: 2516 rolls: 2856		pages: 2530 rolls: 2870
	pages: 2517 rolls: 2857		pages: 2531 rolls: 2871
	pages: 2518 rolls: 2858		pages: 2532 rolls: 2872
	pages: 2519 rolls: 2859		pages: 2533 rolls: 2873
	pages: 2520 rolls: 2860		pages: 2534 rolls: 2874
	pages: 2521 rolls: 2861		pages: 2535 rolls: 2875
	pages: 2522 rolls: 2862		pages: 2536 rolls: 2876
	pages: 2523 rolls: 2863		

MODEL NO. PRODUCT

2501* Alpha Book

This three-ring binder contains 3,120 Alpha Codes proportioned to expected usage. Also includes 162 Year Codes and 27 each of 4 solid Color-Codes (Red, Yellow, Blue, Green) for a total of 3,390 Color-Codes. Complete set includes instructions and wall chart for color orientation. *Use 2500 Series Year Code.

2502 Refill Set

For use with above set. Includes 3,120 Alpha Code labels proportioned to expected usage. No Year Codes, Special Codes, Binder or Index.

(see chart) Refill Pages

Replacement pages for above. Sold by individual letter, 10 pages, 240 labels per poly bag. Three-hole punched.

2890 Alpha Roll Set

Complete set of 27 rolls, packaged in outer box to hold rolls in an orderly manner.

(see chart) Alpha Roll Labels

500 labels per roll in dispenser box

GBS – Series 2900

Mylar Pages/Rolls – Jeter Match

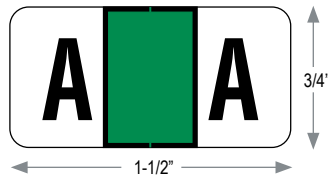

LABEL	MODEL NO.	LABEL	MODEL NO.
	pages: 2910 rolls: 2950		pages: 2924 rolls: 2964
	pages: 2911 rolls: 2951		pages: 2925 rolls: 2965
	pages: 2912 rolls: 2952		pages: 2926 rolls: 2966
	pages: 2913 rolls: 2953		pages: 2927 rolls: 2967
	pages: 2914 rolls: 2954		pages: 2928 rolls: 2968
	pages: 2915 rolls: 2955		pages: 2929 rolls: 2969
	pages: 2916 rolls: 2956		pages: 2930 rolls: 2970
	pages: 2917 rolls: 2957		pages: 2931 rolls: 2971
	pages: 2918 rolls: 2958		pages: 2932 rolls: 2972
	pages: 2919 rolls: 2959		pages: 2933 rolls: 2973
	pages: 2920 rolls: 2960		pages: 2934 rolls: 2974
	pages: 2921 rolls: 2961		pages: 2935 rolls: 2975
	pages: 2922 rolls: 2962		pages: 2936 rolls: 2976
	pages: 2923 rolls: 2963		

MODEL NO. PRODUCT

2901* Mini Alpha Book

2901-A** Mini Alpha Book

The Alpha Series is for use with smaller 9-1/2" W x 6" H folder systems or for more labeling flexibility on standard-size files. Complete set comes in a compact three-ring binder with indexes. Includes 3,105 Alpha Codes proportioned to expected usage. Also includes 162 Year Codes and 27 each of 4 Solid Color-Codes (Red, Yellow, Blue, Green) for a total of 3,375 Color-Codes. Instructions and color wall chart for orientation are included. *Use 5800 Series Year Code. **Use 2500 Series Year Code.

2902* Refill Set

For use with above set. Includes 3,105 Alpha Code labels proportioned to expected usage. No Year Codes, Special Codes, Binder or Index.

(see chart) Refill Pages

Replacement pages for above. Sold by individual letter, 10 pages, 270 labels per polybag.

2990 Mini Alpha Roll Set

Complete set of 27 rolls, packaged in outer box to hold rolls in an orderly manner.

(see chart) Mini Alpha Roll Labels

Packaged 500 labels per roll in dispenser box.

GBS – Series 5100

Mylar Sheets/Rolls – TAB Match

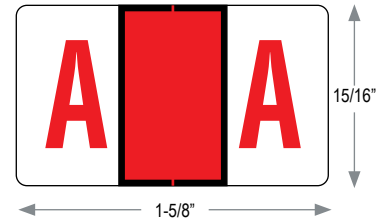

LABEL	MODEL NO.	LABEL	MODEL NO.
	sheets: 5110		sheets: 5125
	sheets: 5111		sheets: 5126*
	sheets: 5112		sheets: 5127**
	sheets: 5113		sheets: 5128**
	sheets: 5114		sheets: 5129
	sheets: 5115*		sheets: 5130
	sheets: 5116**		sheets: 5131
	rolls: 5156**		sheets: 5132
	rolls: 5156**		sheets: 5133
	rolls: 5156**		sheets: 5134
	rolls: 5156**		sheets: 5135
	rolls: 5156**		sheets: 5136
	rolls: 5156**		sheets: 5137
	rolls: 5156**		

MODEL NO. PRODUCT

5101* TAB Match Alpha Kit

5102** Jeter/TAB Match Alpha Kit

2,900 color-coding labels in a compact plastic file box. Labels proportioned based on usage. Complete with A-Z index set. * Alpha Kit-Blue F & O Systems (TAB Match) ** Alpha Kit-Yellow F & O Systems (Jeter)

5103* TAB Match Refill Set

5104** Jeter/TAB Match Refill Set

* Refills a 5101 Alpha Kit. ** Refills a 5102 Alpha Kit. 2900 Alpha Codes

(see chart) Refill Sheets

Polybags of 225 labels of individual code..

Labels – Alphabetic

GBS – Series 5200 Mylar Pages - SAFEGUARD Match

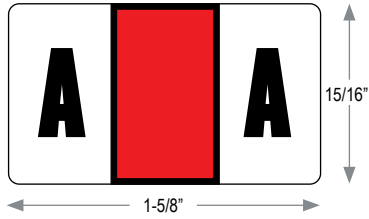

LABEL	MODEL NO.	LABEL	MODEL NO.
	pages: 5210		pages: 5224
	pages: 5211		pages: 5225
	pages: 5212		pages: 5226
	pages: 5213		pages: 5227
	pages: 5214		pages: 5228
	pages: 5215		pages: 5229
	pages: 5216		pages: 5230
	pages: 5217		pages: 5231
	pages: 5218		pages: 5232
	pages: 5219		pages: 5233
	pages: 5220		pages: 5234
	pages: 5221		pages: 5235
	pages: 5222		pages: 5236
	pages: 5223		

MODEL NO. PRODUCT

5201 Safeguard Match Alpha Book
This three-ring binder contains 3,120 Alpha Codes proportioned to expected usage, instructions and a wall chart for color orientation.

5202 Refill Set
For use with above set. Includes 3,120 Alpha Code labels only. No Binder, Index, Year or Special Codes.

(see chart) Refill Set
Replacement pages for above. Sold by individual letter, 10 pages, 240 labels per polybag. Three-hole punched.

GBS Color Control Labels Alphabetic - 1.3" H x 1.25" W



LABEL	MODEL NO.	LABEL	MODEL NO.
	pages: 8848-A rolls: 8850-A		pages: 8848-N rolls: 8850-N
	pages: 8848-B rolls: 8850-B		pages: 8848-O rolls: 8850-O
	pages: 8848-C rolls: 8850-C		pages: 8848-P rolls: 8850-P
	pages: 8848-D rolls: 8850-D		pages: 8848-Q rolls: 8850-Q
	pages: 8848-E rolls: 8850-E		pages: 8848-R rolls: 8850-R
	pages: 8848-F rolls: 8850-F		pages: 8848-S rolls: 8850-S
	pages: 8848-G rolls: 8850-G		pages: 8848-T rolls: 8850-T
	pages: 8848-H rolls: 8850-H		pages: 8848-U rolls: 8850-U
	pages: 8848-I rolls: 8850-I		pages: 8848-V rolls: 8850-V
	pages: 8848-J rolls: 8850-J		pages: 8848-W rolls: 8850-W
	pages: 8848-K rolls: 8850-K		pages: 8848-X rolls: 8850-X
	pages: 8848-L rolls: 8850-L		pages: 8848-Y rolls: 8850-Y
	pages: 8848-MC rolls: 8850-MC		pages: 8848-Z rolls: 8850-Z
	pages: 8848-M rolls: 8850-M		

MODEL NO. PRODUCT

8848 Sheets
Package of 200 of any one Specified Label (A thru Z & Mc), 25 sheets of 8 labels per sheet, three holes punched for binder. 200 labels.

8850 Rolls
Dispenser box of 250 of any one Specified label. (A thru Z)

Jeter – Series 5400 Mylar Pages - GBS Match

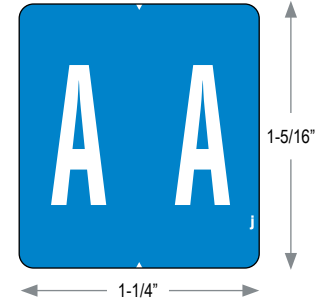

LABEL	MODEL NO.	LABEL	MODEL NO.
	pages: 5410		pages: 5424
	pages: 5410		pages: 5425
	pages: 5412		pages: 5426
	pages: 5413		pages: 5427
	pages: 5414		pages: 5428
	pages: 5415		pages: 5429
	pages: 5416		pages: 5430
	pages: 5417		pages: 5431
	pages: 5418		pages: 5432
	pages: 5419		pages: 5433
	pages: 5420		pages: 5434
	pages: 5421		pages: 5435
	pages: 5422		pages: 5436
	pages: 5423		

MODEL NO. PRODUCT

5401 GBS Match Alpha Book
This three-ring binder contains 2,340 Alpha Codes proportioned to expected usage, instructions and a wall chart for color orientation.

5402 Refill Set
For use with above set. Includes 2,340 Alpha Code labels proportioned to expected usage.

(see chart) Refill Set
Replacement pages for above. Sold by individual letter, 10 pages, 180 labels per polybag. Three-hole punched.



Compucolor

Social Security Numbers, Account Numbers, Credit Cards, Zip Codes invoice number, dates can all be identified with these self adhesive numeric color coding labels. Available in boxes of 500.

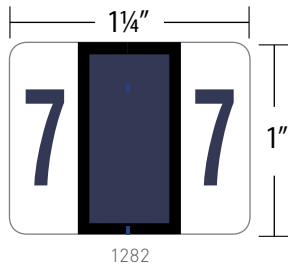

1" High Compucolor – Replace * with desired number 0 - 9

MODEL NO.	DESCRIPTION	QUANTITY
1282-*	1" High Numeric Color Label	roll of 500/box
1282-50	1" High Numeric Color Label Complete Set – 1 box each	1 set

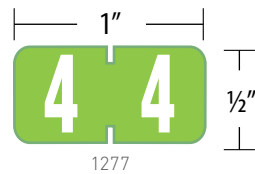

1/2" High Compucolor – Replace * with desired number 0 - 9

MODEL NO.	DESCRIPTION	QUANTITY
1277-*	1/2" High Numeric Color Label	roll of 500/box
1277-50	1/2" High Numeric Color Label Complete Set 0 to 9 Box	1 set



Numeric Labels

Social Security Numbers, Account Numbers, Credit Cards, Zip Codes invoice number, and dates can all be identified with these self adhesive numeric color coding labels. Available in boxes of 500.

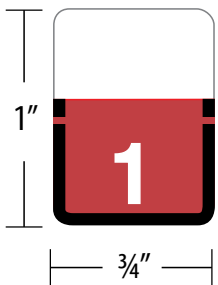

Top Tab Numeric Labels

Numeric – Replace ** with desired number 0-9

MODEL NO.	DESCRIPTION	QUANTITY
1306-**	1" High Numeric Color Label	box of 500
1306-50	1" High Numeric Color Label Complete Set 0-9	1 set



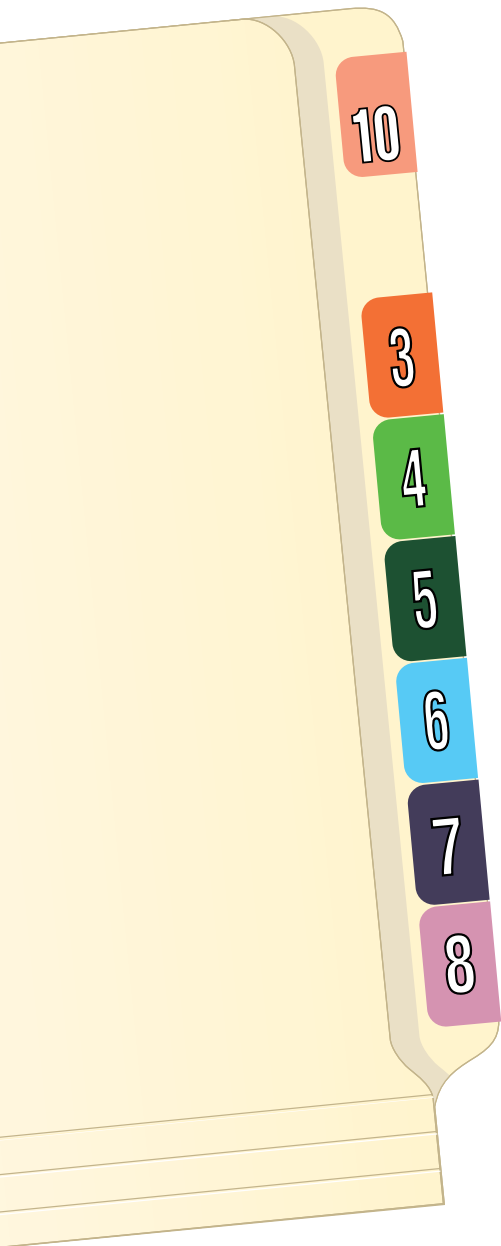

Datafile® Numeric Labels

Social Security Numbers, Account Numbers, Credit Cards, Zip Codes invoice number, and dates can all be identified with these self adhesive numeric color coding labels. Available in boxes of 500.

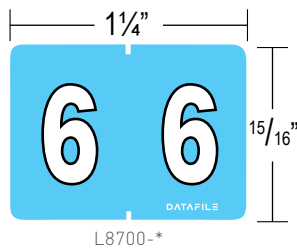

Full Size Numeric – Replace * with desired number 0-9

MODEL NO.	DESCRIPTION	QUANTITY
L8700-*	Numeric Color Label	box of 500
L8706	Numeric Color Label Complete Set 0-9	1 set

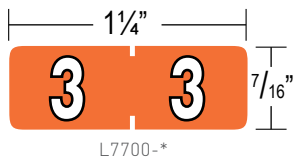

Half Size Numeric – Replace * with desired number 0-9

MODEL NO.	DESCRIPTION	QUANTITY
L7700-*	Numeric Color Label	box of 500

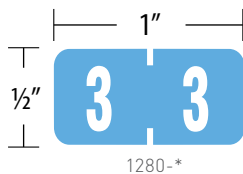

TABSTIK Numeric – Replace * with desired number 0-9

MODEL NO.	DESCRIPTION	QUANTITY
1280-*	1/2" High TABSTIK Numeric Classification Labels	roll of 1000
1280-50	1/2" High Numeric Color Label Classification Labels Complete Set 0-9	set



AMES Numeric Color Coded Labels

Reduce misfiles with color coding. A break in the color pattern instantly signals a misfile. Two color bars reduce the potential for misfiles to within 1% of the total file; three color bars to within 1/10%.

AMES 1-7/8" Large Digit Reverse-Block Numeric Labels

- Size: 1-7/8" x 1-7/8".
- Choose standard synthetic latex or polyester laminated labels.
- Features permanent adhesive and release coated paper backing.
- Packaged in self-dispensing boxes.



1-7/8" x 1-7/8"

Individual Digit Boxes

ITEM DESCRIPTION	LBS./UNIT	QUANTITY
Laminated	1 lb.	box of 500

Label Sets (1 box each of 10 AMES colors)

Laminated	10 lbs.	1 set of 10 boxes
-----------	---------	-------------------

LAMINATED

MODEL NO.	COLOR	DIGIT
L-A-00178RLP	AMES Red	0
L-A-01178RLP	AMES Grey	1
L-A-02178RLP	AMES Blue	2
L-A-03178RLP	AMES Orange	3
L-A-04178RLP	AMES Purple	4
L-A-05178RLP	AMES Black	5
L-A-06178RLP	AMES Yellow	6
L-A-07178RLP	AMES Brown	7
L-A-08178RLP	AMES Pink	8
L-A-09178RLP	AMES Green	9
L-A-ST178RLP	Label Set	0-9



AMES 1-7/8" Small Digit Reverse-Block Numeric Labels

- Size: 1-7/8" x 1-7/8".
- Made from synthetic latex stock for greater flexibility and longer life.
- Features permanent adhesive and release coated paper backing.
- Packaged in self-dispensing boxes.

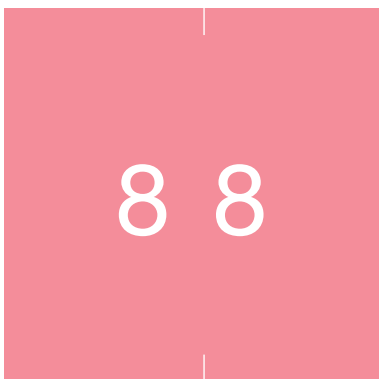

1-7/8" x 1-7/8"

Individual Digit Boxes

MODEL NO.	LBS./UNIT	QUANTITY
See below	1 lb.	box of 500

Label Sets (1 box each of 10 AMES colors)

L-A-ST178RS	10 lbs.	1 set of 10 boxes
-------------	---------	-------------------

MODEL NO.	COLOR	DIGIT
L-A-00178RS	AMES Red	0
L-A-01178RS	AMES Grey	1
L-A-02178RS	AMES Blue	2
L-A-03178RS	AMES Orange	3
L-A-04178RS	AMES Purple	4
L-A-05178RS	AMES Black	5
L-A-06178RS	AMES Yellow	6
L-A-07178RS	AMES Brown	7
L-A-08178RS	AMES Pink	8
L-A-09178RS	AMES Green	9
L-A-ST178RS	Label Set	0-9



AMES 9/16" x 1-3/4" Reverse-Block Numeric Labels

- Size: 9/16" x 1-3/4".
- Made from synthetic latex for greater flexibility.
- Features permanent adhesive and release coated paper backing.
- Labels come in rolls.



1-3/4"

Individual Digit Rolls

MODEL NO.	LBS./UNIT	QUANTITY
See below	1/2 lb.	roll of 1000

Label Sets (1 roll each of 10 AMES colors)

L-A-ST134RB	5 lbs.	1 set of 10 rolls
-------------	--------	-------------------

MODEL NO.	COLOR	DIGIT
L-A-00134RB	AMES Red	0
L-A-01134RB	AMES Grey	1
L-A-02134RB	AMES Blue	2
L-A-03134RB	AMES Orange	3
L-A-04134RB	AMES Purple	4
L-A-05134RB	AMES Black	5
L-A-06134RB	AMES Yellow	6
L-A-07134RB	AMES Brown	7
L-A-08134RB	AMES Pink	8
L-A-09134RB	AMES Green	9
L-A-ST134RB	Label Set	0-9

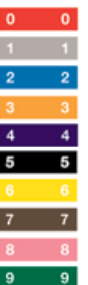

Labels – Numeric

GBS Series 0300 Mylar Rolls - Jeter Match

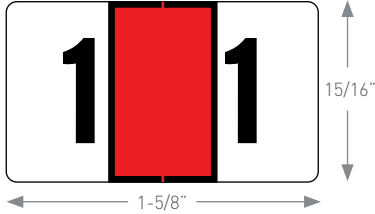

LABEL	MODEL NO.	LABEL	MODEL NO.
	rolls: 0301		rolls: 0306
	rolls: 0302		rolls: 0307
	rolls: 0303		rolls: 0308
	rolls: 0304		rolls: 0309
	rolls: 0305		rolls: 0310

MODEL NO. PRODUCT

0311 **Numeric Roll Set**
Complete set of 10 rolls, packaged in outer box to hold rolls in an orderly manner.

(see chart) **Numeric Roll Labels**
500 labels per roll in dispenser box.

GBS Series 2600 Mylar Rolls - Jeter Match

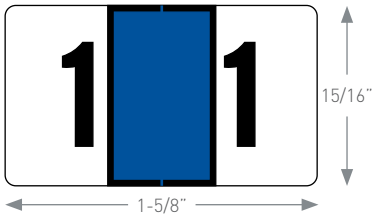

LABEL	MODEL NO.	LABEL	MODEL NO.
	rolls: 2671		rolls: 2676
	rolls: 2672		rolls: 2677
	rolls: 2673		rolls: 2678
	rolls: 2674		rolls: 2679
	rolls: 2675		rolls: 2680

MODEL NO. PRODUCT

2690 **Numeric Roll Set**
Complete set of 10 rolls, packaged in outer box to hold rolls in an orderly manner.

(see chart) **Numeric Roll Labels**
500 labels per roll in dispenser box.

GBS Series 3000/7400 Mylar Rolls/Pages - Jeter Match

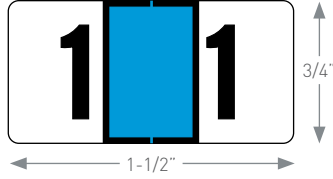

LABEL	MODEL NO.	LABEL	MODEL NO.
	rolls: 3071 pages 7411		rolls: 3076 pages 7416
	rolls: 3072 pages 7412		rolls: 3077 pages 7417
	rolls: 3073 pages 7413		rolls: 3078 pages 7418
	rolls: 3074 pages 7414		rolls: 3079 pages 7419
	rolls: 3075 pages 7415		rolls: 3080 pages 7410

MODEL NO. PRODUCT

3090 **Mini Numeric Roll Set**
Complete set of 10 rolls, packaged in outer box to hold rolls in an orderly manner. Includes a wall chart for color orientation.

(see chart) **Mini Numeric Roll Labels**
500 labels per roll in dispenser box.

7401 **Mini Numeric Book**
Matches the 3000 Series. Three-ring binder contains 4,050 Numeric Codes, 405 labels each. Includes instructions.

7402 **Refill Set**
Includes 4,050 numeric codes only. No binder or index.

(see chart) **Refill Pages**
Replacement Numeric Pages for End Coder Book. Numeric labels only. 11 pages, 275 labels per polybag. Three-hole punched.

Jeter Series 7300 Mylar Rolls

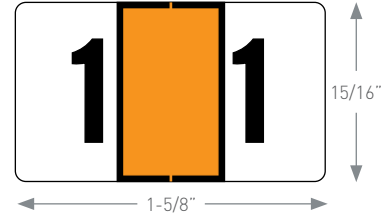

LABEL	MODEL NO.	LABEL	MODEL NO.
	rolls: 7371		rolls: 7376
	rolls: 7372		rolls: 7377
	rolls: 7373		rolls: 7378
	rolls: 7374		rolls: 7379
	rolls: 7375		rolls: 7380

MODEL NO. PRODUCT

7390 **Numeric Roll Set**
Complete set of 10 rolls, packaged in outer box to hold rolls in an orderly manner.

(see chart) **Numeric Roll Labels**
500 labels per roll in dispenser box.

Jeter Series 7700-R Mylar Rolls



LABEL	MODEL NO.	LABEL	MODEL NO.
	rolls: 7771-R		rolls: 7776-R
	rolls: 7772-R		rolls: 7777-R
	rolls: 7773-R		rolls: 7778-R
	rolls: 7774-R		rolls: 7779-R
	rolls: 7775-R		rolls: 7780-R

MODEL NO. PRODUCT

7790-R **Double J Num. Roll Set**
Complete set of 10 rolls, packaged in outer box to hold rolls in an orderly manner.

(see chart) **Double J Num. Roll Labels**
500 labels per roll in dispenser box.

Labels – Numeric

Jeter Series 5300 Mylar Rolls

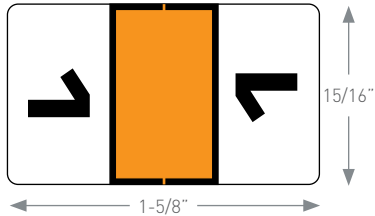

LABEL	MODEL NO.	LABEL	MODEL NO.
	rolls: 5371		rolls: 5376
	rolls: 5372		rolls: 5377
	rolls: 5373		rolls: 5378
	rolls: 5374		rolls: 5379
	rolls: 5375		rolls: 5380

MODEL NO. PRODUCT

5390 Top Coder Num. Roll Set
Complete set of 10 rolls, packaged in outer box to hold rolls in an orderly manner.

(see chart) Top Coder Num. Roll Labels
For use on top tab folders. 500 labels per roll in dispenser box.

Jeter Series 8000 Mylar Rolls - TRACO Match

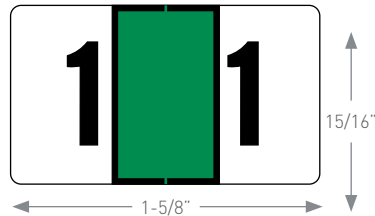

LABEL	MODEL NO.	LABEL	MODEL NO.
	rolls: 8001		rolls: 8006
	rolls: 8002		rolls: 8007
	rolls: 8003		rolls: 8008
	rolls: 8004		rolls: 8009
	rolls: 8005		rolls: 8010

MODEL NO. PRODUCT

8011 TRACO Match Num. Roll Set
Complete set of 10 rolls, packaged in outer box to hold rolls in an orderly manner.

(see chart) TRACO Match Num. Roll Labels
Colors match TRACO systems. 500 labels per roll in dispenser box.

Jeter Series 8800 Mylar Rolls/Pages

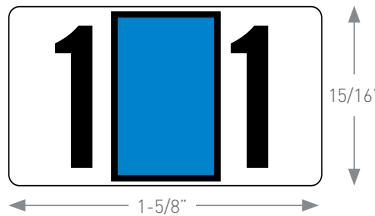

LABEL	MODEL NO.	LABEL	MODEL NO.
	rolls: 8851 pages 8871		rolls: 8856 pages 8876
	rolls: 8852 pages 8872		rolls: 8857 pages 8877
	rolls: 8853 pages 8873		rolls: 8858 pages 8878
	rolls: 8854 pages 8874		rolls: 8859 pages 8879
	rolls: 8855 pages 8875		rolls: 8860 pages 8880

MODEL NO. PRODUCT

8861 Numeric Roll Set
Complete set of 10 rolls, packaged in outer box to hold rolls in an orderly manner.

(see chart) Numeric Roll Labels
500 labels per roll in dispenser box.

8801 Numeric Book
This three-binder contains 3,600 numeric codes, 360 labels each.

8802 Refill Set
Includes 3,600 numeric codes only. No binder or index.

(see chart) Refill Pages
Replacement pages. 240 labels per package. Three-hole punched.

Jeter Series 4500 Mylar Rolls - Black on White

LABEL	MODEL NO.	LABEL	MODEL NO.
	rolls: 4501		rolls: 4506
	rolls: 4502 DD0550-00		rolls: 4507
	rolls: 4503		rolls: 4508
	rolls: 4504		rolls: 4509
	rolls: 4505		rolls: 4500

MODEL NO. PRODUCT

4510 Numeric Roll Set
Complete set of 10 rolls, packaged in outer box to hold rolls in an orderly manner.

(see chart) Numeric Roll Labels
Actual Size: 1-1/2" w. x 3/4" h. All labels have the digit printed in black on a white field. Convenient for use when all digits of a number set need to be shown, but not necessarily color-coded. 500 labels per roll in dispenser box.

Jeter Series 0100 Mylar Rolls

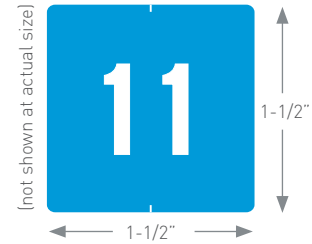

LABEL	MODEL NO.	LABEL	MODEL NO.
	rolls: 0101		rolls: 0106
	rolls: 0102		rolls: 0107
	rolls: 0103		rolls: 0108
	rolls: 0104		rolls: 0109
	rolls: 0105		rolls: 0110

MODEL NO. PRODUCT

0111 Numeric Roll Set
Complete set of 10 rolls, packaged in outer box to hold rolls in an orderly manner.

(see chart) Numeric Roll Labels
500 labels per roll in dispenser box.

Jeter Series 9000 Mylar Rolls - ACME Match

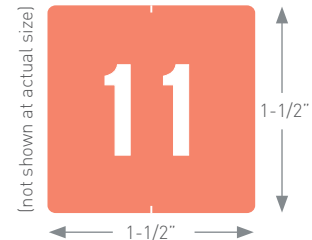

LABEL	MODEL NO.	LABEL	MODEL NO.
	rolls: 9001		rolls: 9006
	rolls: 9002		rolls: 9007
	rolls: 9003		rolls: 9008
	rolls: 9004		rolls: 9009
	rolls: 9005		rolls: 9000

MODEL NO. PRODUCT

9010 Acme Match Roll Set
Complete set of 10 rolls, packaged in outer box to hold rolls in an orderly manner.

(see chart) Acme Match Roll Labels
Regular 9000 Series colors matches early ACME and SFI Coda-Color. 500 labels per roll in dispenser box.

Labels – Numeric

Jeter Series 9600 Mylar Rolls - ACME Match

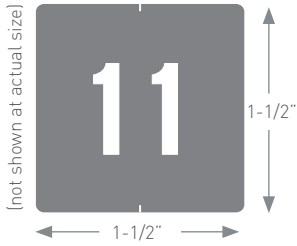

LABEL	MODEL NO.	LABEL	MODEL NO.
11	rolls: 9601	00	rolls: 9606
22	rolls: 9602	77	rolls: 9607
33	rolls: 9603	88	rolls: 9608
44	rolls: 9604	99	rolls: 9609
55	rolls: 9605	00	rolls: 9600

MODEL NO. PRODUCT

9610 GBS Match Roll Set
Complete set of 10 rolls, packaged in outer box to hold rolls in an orderly manner.
(see chart) GBS Match Roll Labels
Colors match DIEBOLD System ovals. 500 labels per roll in dispenser box.

Jeter Series 9700 Mylar Rolls - SFI Match

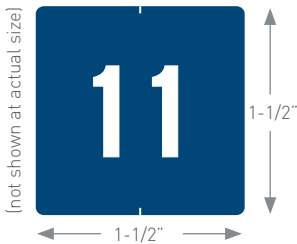

LABEL	MODEL NO.	LABEL	MODEL NO.
11	rolls: 9701	00	rolls: 9706
22	rolls: 9702	77	rolls: 9707
33	rolls: 9703	88	rolls: 9708
44	rolls: 9704	99	rolls: 9709
55	rolls: 9705	00	rolls: 9700

MODEL NO. PRODUCT

9710 SFI Match Roll Set
Complete set of 10 rolls, packaged in outer box to hold rolls in an orderly manner.
(see chart) SFI Match Roll Labels
Colors match Coda-Color/SFI Systems. 500 labels per roll in dispenser box.

Jeter Series 7600 Mylar Rolls/Pages

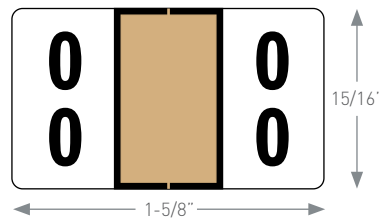

LABEL	MODEL NO.	LABEL	MODEL NO.
00	00-09 7600	50	50-59 7650
10	10-19 7610	60	60-69 7660
20	20-29 7620	70	70-79 7670
30	30-39 7630	80	80-89 7680
40	40-49 7640	90	90-99 7690

MODEL NO. PRODUCT

7691 Double-Digit Num. Roll Set Roll Set
Complete set of 10 rolls, packaged in outer box to hold rolls in an orderly manner.

(see above) Double-Digit Num. Roll Labels
Double-digit labels for coding the tens and unit digits in straight numeric filing systems. Colors are keyed to 7300 Series labels. Ten colors. First label numbered 00, then 01 thru 09. Each series repeats 50 times per roll. 500 labels per roll in dispenser box.

(see below) Double-Digit Pages
7600 Series labels are also available in pages. There are two numbers per page: 00-01, 02-03, etc. Each page has 24 labels. Each package contains 10 pages of labels. Colors keyed to 7300 Series

NUMBER	MODEL NO.	COLOR	NUMBER	MODEL NO.	COLOR	NUMBER	MODEL NO.	COLOR
00-01	7600-01	tan	34-35	7634-35	purple	68-69	7668-69	light green
02-03	7602-03	tan	36-37	7636-37	purple	70-71	7670-71	black
04-05	7604-05	tan	38-39	7638-39	purple	72-73	7672-73	black
06-07	7606-07	tan	40-41	7640-41	light blue	74-75	7674-75	black
08-09	7608-09	tan	42-43	7642-43	light blue	76-77	7676-77	black
10-11	7610-11	fl. orange	44-45	7644-45	light blue	78-79	7678-79	black
12-13	7612-13	fl. orange	46-47	7646-47	light blue	80-81	7680-81	yellow
14-15	7614-15	fl. orange	48-49	7648-49	light blue	82-83	7682-83	yellow
16-17	7616-17	fl. orange	50-51	7650-51	red	84-85	7684-85	yellow
18-19	7618-19	fl. orange	52-53	7652-53	red	86-87	7686-87	yellow
20-21	7620-21	dk. green	54-55	7654-55	red	88-89	7688-89	yellow
22-23	7622-23	dk. green	56-57	7656-57	red	90-91	7690-91	dark blue
24-25	7624-25	dk. green	58-59	7658-59	red	92-93	7692-93	dark blue
26-27	7626-27	dk. green	60-61	7660-61	light green	94-95	7694-95	dark blue
28-29	7628-29	dk. green	62-63	7662-63	light green	96-97	7696-97	dark blue
30-31	7630-31	purple	64-65	7664-65	light green	98-99	7698-99	dark blue
32-33	7632-33	purple	66-67	7666-67	light green			

Jeter Series 4600 Mylar Rolls

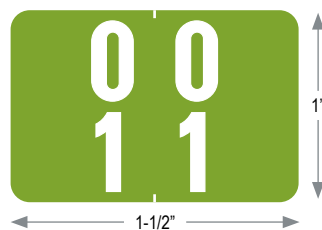

LABEL	MODEL NO.	LABEL	MODEL NO.
00	00-09 DD0550-00	55	50-59 DD0550-50
11	10-19 DD0550-10	66	60-69 DD0550-60
22	20-29 DD0550-20	77	70-79 DD0550-70
33	30-39 DD0550-30	88	80-89 DD0550-80
44	40-49 DD0550-40	99	90-99 DD0550-90

MODEL NO. PRODUCT

(see chart) Double-Digit Num. Roll Labels Double-Digit labels for coding the tens and unit digits in straight numeric filing systems. Colors are keyed to 9000 Series labels. Ten colors, first label numbered 00, then 01 thru 09. Each series repeats 50 times per roll. 500 labels per roll in dispenser box.

Labels – Solid Color

TAB Solid Color Labels

Replace ** with desired color number

MODEL NO.	DESCRIPTION	QUANTITY
1281-**	1/2" High Solid Color Classification Labels	box of 1000
1281-50	1/2" High Solid Color Classification Labels (12 colors)	1 set

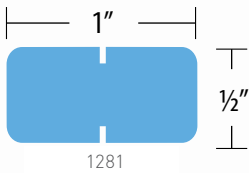

AMES Solid Block Color Labels

- Available in two sizes: 1-7/8" x 1-7/8" and 9/16" x 1-3/4"
- Made from synthetic latex stock for greater flexibility and longer life.
- Features permanent adhesive and release coated paper backing.
- 1-7/8" labels come in self-dispensing boxes; 1/2" labels come in rolls.

Individual Colors

MODEL NO.	DESCRIPTION	LBS./UNIT	QUANTITY
See Chart (large)	1-7/8" x 1-7/8"	1 lb.	box of 500
See Chart (small)	9/16" x 1-3/4"	1/2 lb.	roll of 1000

Label Sets (1 box/roll each of 10 AMES colors)

L-A-ST178 (large)	1-7/8" x 1-7/8"	10 lbs.	1 set of 10 boxes
L-A-ST134 (small)	9/16" x 1-3/4"	10 rolls/set	1 set of 10 rolls

LARGE 1-7/8" x 1-7/8"		SMALL 9/16" x 1-3/4"	COLOR
MODEL NO.	MODEL NO.		
L-A-00178	L-A-00134		AMES Red
L-A-01178	L-A-01134		AMES Grey
L-A-02178	L-A-02134		AMES Blue
L-A-03178	L-A-03134		AMES Orange
L-A-04178	L-A-04134		AMES Purple
L-A-05178	L-A-05134		AMES Black
L-A-06178	L-A-06134		AMES Yellow
L-A-07178	L-A-07134		AMES Brown
L-A-08178	L-A-08134		AMES Pink
L-A-09178	L-A-09134		AMES Green
—	L-A-0A134		Aqua
—	L-A-0G134		Gold
L-A-0T178	L-A-0T134		Natural Wallet
L-A-0W178	L-A-0W134		White
L-A-ST178	L-A-ST134		AMES Colors Only

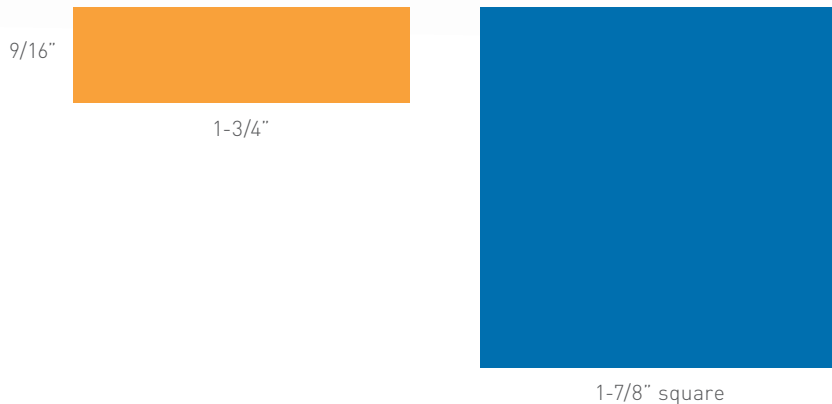

Labels – Solid Color

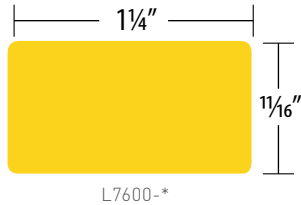

DataFile® Solid Color Labels

Replace * with desired color number

MODEL NO.	DESCRIPTION	QUANTITY
L7600-*	Solid Color label	box of 500



Jeter Series 6200 Mini-Solid - Removable Rolls



MODEL NO.	PRODUCT/COLOR
6220	Red
6222	Dark Blue
6226	Yellow
06-07	Green
08-09	Orange

Solid colors indicate specific classifications of records. Removable adhesive back permits easy label change when classifications change. 2,000-label rolls.

Jeter Series 6300 Mini-Solid - Removable Rolls

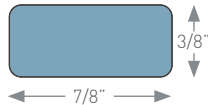

MODEL NO.	PRODUCT/COLOR
6313	Light Blue
6320	Red
6322	Dark Blue
6323	Orange
6324	Purple
6325	Black
6326	Yellow
6327	Brown
6329	Green

Mini-size special coding labels available in seven colors. Special latex-based paper stock ensures excellent adhesion. Dispenser box contains 2,000 labels.

Jeter Protect Labels Clear Mylar

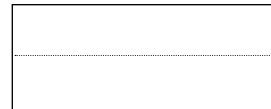

MODEL NO.	PRODUCT
1835	Mylar Protect Label Original standard 3-1/2" w x 1-3/4" h. Seals typed name labels under clear Mylar film to prevent peeling, tearing and smudging. Wrap-around design strengthens the folder edge. 500 per package.
1935	Mini Mylar Protect Label Mini size 2-1/2" w x 1-3/4" h. Seals typed Mini Name Labels No. 1820 or 1821. 500 per package.
1735	Large Mylar Protect Label Large size 5-1/4" w x 1-3/4" h. Label extends past name label where a year band or other code can be placed on top for easy removal. Also used for reinforcement of high activity folders. 500 per package.
2035	X-Large Mylar Protect Label Same as above, except in extra-large size: 8" w x 1-3/4" h. 500 per package.
2035-100	X-Large Mylar Protect Label Same as above, except 100 per package.

Labels – Name

TABSTIK Name Labels

MODEL NO.	DESCRIPTION	QUANTITY
1389-00	Dark Green	box of 750
1390-00	White	box of 750
1394-00	Red	box of 750
1396-00	Purple	box of 750
1397-00	Dark Blue	box of 750
1398-00	Light Blue	box of 750
1401-00	Tan	box of 750
1303-90	White for Laser Printers	box of 750

MODEL NO.	PRODUCT
1851	Alignment Marks - Single Feed 1000 per package.
LZR-Label	Laser Printer - Plain White Plain white name labels on 8-1/2" W x 11" H sheets with 30 labels per page. Packaged in a polybag to resist warpage. For use in laser printers. 50 sheets, 1,500 per package. In Word-Avery Format #5266
(see chart)	Color Striped- above Color striped, fan-folded and perforated for separation. Complete instructions for correct usage on both end tab and top tab folders. Single-feed, 375 per package.
1820	Mini-Plain White 2-1/2" W x 5/8" H Mini name labels, plain white without alignment marks. Fan folded and perforated. Pin fed for computer printers. Double fee, 1,000 per package.
1821	Mini-Alignment Marks- 2-1/2" W x 5/8" H White mini name labels with alignment marks. Fan folded and perforated. Pin fed for computer printers. Double fee, 1,000 per package.

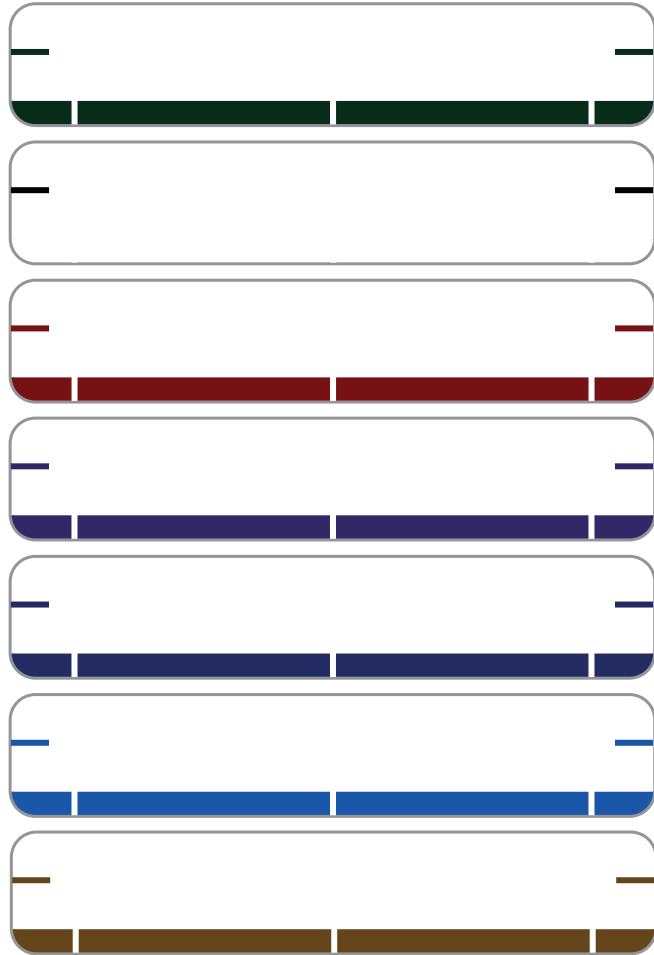

TABSTIK label colors Actual label size is 3³/₈" x 5⁵/₈"

Labels – Jeter Medical

Medicaid/Medicare Labels Mylar Sheets/Pages

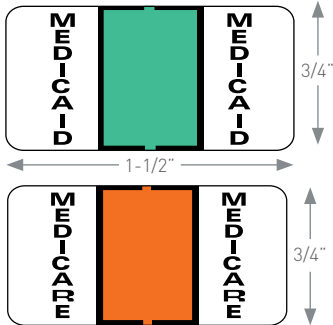

MODEL NO. PRODUCT

7106	Medicaid (aqua) Format: Sheets for end tab kits. (240 labels total)
5806	Medicaid (aqua) Format: Pages for end code books. (270 labels total)
7107	Medicare (orange) Format: Sheets for end tab kits. (240 labels total)
5807	Medicare (orange) Format: Pages for end code books. (270 labels total)

Write-In Boxes

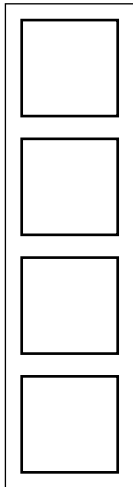

1/2" Size

MODEL NO.	PRODUCT	ITEM
1114	Write-In Boxes (1/2")	4 Box

Use these labels to cover digits so you can reuse folders with a new number. One label for each side of folder tab. Labels match our standard strip label write-in boxes. All labels packaged 250 per roll.

Medical Labels Non-Mylar Rolls/Pages

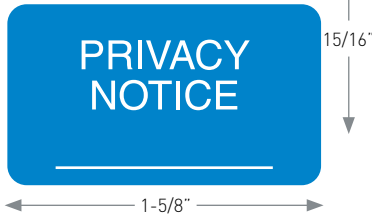

MODEL NO. PRODUCT

PRIVACY	Privacy Notice (blue) Format: Rolls (500 labels total – Non-Mylar)
----------------	--

Allergy Labels Mylar/Non-Mylar Rolls/Sheets/Pages

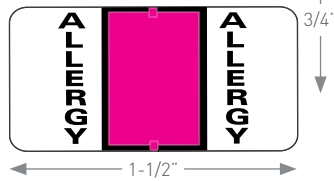

MODEL NO. PRODUCT

7108	Allergy Labels (flourescent pink) Format: Sheets for end tab kits. (240 labels total)
5808	Allergy Labels (flourescent pink) Format: Pages for end code books. (270 labels total)
ALLERGY Small	Allergy Labels (flourescent orange) Format: Roll format. (500 labels total)
ALLERGY Large	Allergy Labels (flourescent orange) Format: Roll format. (500 labels total)

Series 9500 Solid Coding Labels - Mylar Rolls

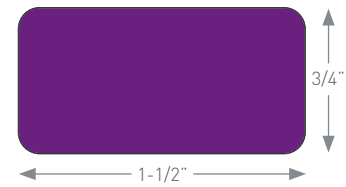

MODEL NO.	COLOR	MODEL NO.	COLOR
9520	red	9528	pink
9521	gray taupe	9529	green
9522	blue	9530	white
9523	orange	9532	true gray
9524	purple	9533	gold
9525	black	9534	fl. orange
9526	yellow	9535	tan
9527	brown		

MODEL NO. PRODUCT

9531	Solid Color Roll Set Complete set of rolls of first 12 colors, packaged in outer box to hold rolls in an orderly manner.
(see chart)	Solid Color Roll Labels For both end code and top code systems. Ideal for special coding requirements. 500 labels per roll in dispenser box.

Series 5300 Solid Coding Labels - Mylar Pages

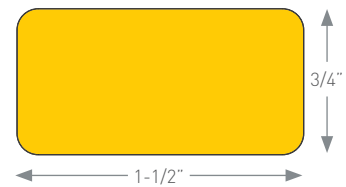

MODEL NO.	PRODUCT/COLOR
5320	Red
5322	Dark Blue
5326	Yellow
5329	Green

Solid colors indicate specific classifications of records. Removable adhesive back permits easy label change when classifications change. 2,000-label rolls. 16 labels per page, 400 labels per pack.

Custom Printed Label

Custom printed strip labels can be printed vertically or horizontally in black ink. When ordering, specify vertical or horizontal and the print copy desired. Maximum digits horizontally is 3 and vertically is 6. 500 labels/box.

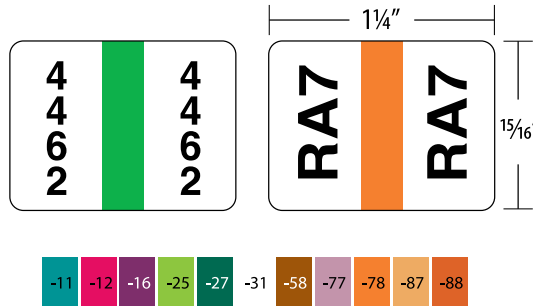

MODEL NO.	DESCRIPTION	QUANTITY
DF737-11	Light Blue	box of 500
DF737-12	Red	box of 500
DF737-16	Purple	box of 500
DF737-25	Light Green	box of 500
DF737-27	Dark Green	box of 500
DF737-31	White	box of 500
DF737-58	Brown	box of 500
DF737-77	Lavender	box of 500
DF737-78	Pink	box of 500
DF737-87	Light Orange	box of 500
DF737-88	Dark Orange	box of 500

Labels – Month/Year

DataFile® Year Labels – Box

Replace ** with desired year number

MODEL NO.	DESCRIPTION	QUANTITY
L8800-**	2 Digit Year Labels	box of 500

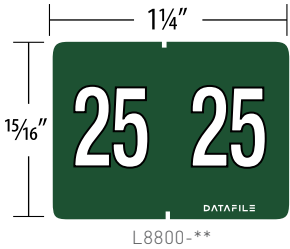

L8800-**

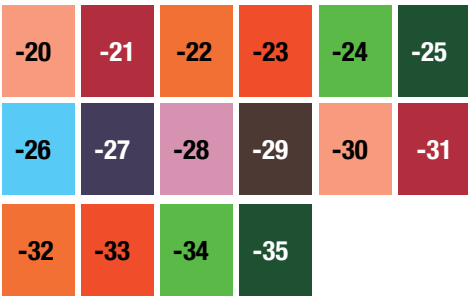

Year Labels

MODEL NO.	DESCRIPTION	QUANTITY
1287-**	1/2" High 2 Digit Year Label (replace ** with number of year desired)	roll of 500
1309-**	1" High 2 Digit Year Label (replace ** with number of year desired)	roll of 500

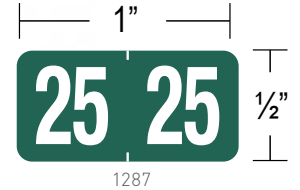

1287

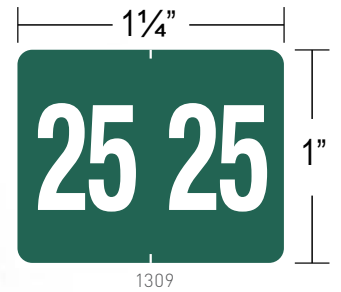

1309

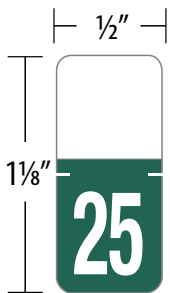

Year Labels

Top Tab Year Code Labels

Year Code – Replace ** with desired year code

MODEL NO.	DESCRIPTION	QUANTITY
1308-**	1 1/8" High 2 Digit Year Code	box of 500



Labels – Month/Year

DataFile® Month Labels – Sheet

Replace ** with desired month number

MODEL NO.	DESCRIPTION	QUANTITY
L8801-**	Month Sheet Labels 16 Label/sheet, 15 sheets/pkg	1 pkg

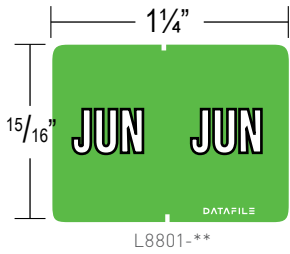

Month Labels

MODEL NO.	DESCRIPTION	QUANTITY
1279-**	1/2" High Month Label (replace ** with number of month desired)	box of 1000
1279-50	1/2" High Month Label	1 set

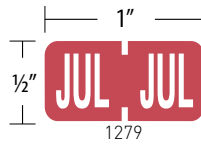

Labels – Month/Year

AMES Large Year Code Labels

- Size: 1-7/8" x 1-7/8".
- Made from synthetic latex stock for greater flexibility and longer life.
- Permanent adhesive.
- Release coated paper backing.
- Packaged in self-dispensing boxes.

Individual Boxes

MODEL NO.	LBS./BOX	QUANTITY
See right	1 lb.	box of 500

MODEL NO.	COLOR	YEAR
L-A-DD20R178	Red	2020
L-A-DD21R178	Gray	2021
L-A-DD22R178	Blue	2022
L-A-DD23R178	Orange	2023
L-A-DD24R178	Purple	2024
L-A-DD25R178	Black	2025
L-A-DD26R178	Yellow	2026
L-A-DD27R178	Brown	2027
L-A-DD28R178	Pink	2028
L-A-DD29R178	Green	2029
L-A-DD30R178	Red	2030
L-A-DD31R178	Gray	2031
L-A-DD32R178	Blue	2032
L-A-DD33R178	Orange	2033
L-A-DD34R178	Purple	2034
L-A-DD35R178	Black	2035

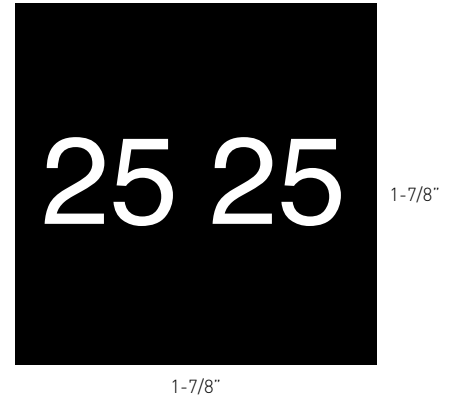

AMES Small Year Code Labels

- Size: 9/16" x 1-3/4".
- Made from synthetic latex stock for greater flexibility and longer life.
- Permanent adhesive.
- Release coated paper backing.
- Labels come in rolls.

Individual Rolls

MODEL NO.	LBS./BOX	QUANTITY
See right	1/2 lb.	roll of 1000

MODEL NO.	COLOR	YEAR
L-A-DD20R134	Red	2020
L-A-DD21R134	Gray	2021
L-A-DD22R134	Blue	2022
L-A-DD23R134	Orange	2023
L-A-DD24R134	Purple	2024
L-A-DD25R134	Black	2025
L-A-DD26R134	Yellow	2026
L-A-DD27R134	Brown	2027
L-A-DD28R134	Pink	2028
L-A-DD29R134	Green	2029
L-A-DD30R134	Red	2030
L-A-DD31R134	Gray	2031
L-A-DD32R134	Blue	2032
L-A-DD33R134	Orange	2033
L-A-DD34R134	Purple	2034
L-A-DD35R134	Black	2035

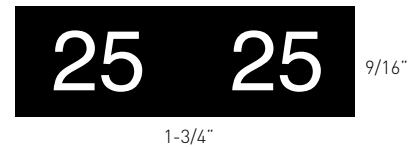

8816-*

GBS Prefix Labels 1/2" H x 1-1/4" W

MODEL NO.	DESCRIPTION	PACKAGE QTY.
8816-*	Dispenser Box of 250 of any specified label (0-9), Black Numbers on White Background	250
8816 Set	10 Dispenser Boxes of 250 8816 Labels [1 each, 0-9], Black Numbers on White Background	2500

Replace * with number



8851-24

GBS Year Band Labels System One, 3/4" H x 1-1/2" W

MODEL NO.	DESCRIPTION	PACKAGE QTY.
8851-**	Dispenser Box of 500 of any One Specified Year Band Label, Reversed Numbers	500

Replace ** with a year



Labels – Month/Year

Jeter Year Labels Mylar Rolls/Pages

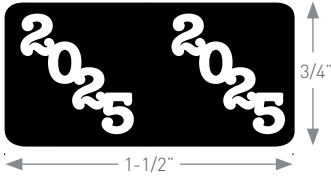

MODEL NO. ROLLS	MODEL NO. PAGES	YEAR	COLOR (bkgnd/type)
2020YB	5820YB	2020	dark bkue/white
2021YB	5821YB	2021	yellow/black
2022YB	5822YB	2022	red/black
2023YB	5823YB	2023	purple/black
2024YB	5824YB	2024	gold/black
2025YB	5825YB	2025	black/white
2026YB	5826YB	2026	orange/black
2027YB	5827YB	2027	white/black
2028YB	5828YB	2028	teal/white
2029YB	5829YB	2029	gray/white
2030YB	5830YB	2030	dark bkue/white
2031YB	5831YB	2031	yellow/black
2032YB	5832YB	2032	red/black
2033YB	5833YB	2033	purple/black
2034YB	5834YB	2034	gold/black
2035YB	5835YB	2035	black/white

MODEL NO. PRODUCT
[see chart] Year Label Rolls

Year labels are a great help in the retirement of old records. Their colors identify quickly and accurately which files are inactive. 500 labels per roll in dispenser box.

[see chart] Year Label Pages

For use in Jeter End Coder Books. 16 pages, 400 labels per polybag.

Jeter Year Labels Mylar Rolls/Pages

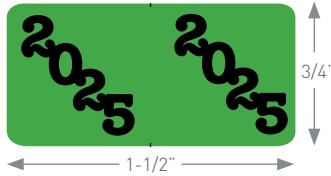

MODEL NO. ROLLS	MODEL NO. PAGES	YEAR	COLOR (bkgnd/type)
2020YB-A	2520YB	2020	yellow/black
2021YB-A	2521YB	2021	black/white
2022YB-A	2522YB	2022	pink/black
2023YB-A	2523YB	2023	light blue/black
2024YB-A	2524YB	2024	red/black
2025YB-A	2525YB	2025	grass green/black
2026YB-A	2526YB	2026	gray/white
2027YB-A	2527YB	2027	purple/white
2028YB-A	2528YB	2028	white/black
2029YB-A	2529YB	2029	orange/black
2030YB-A	2530YB	2030	yellow/black
2031YB-A	2531YB	2031	black/white
2032YB-A	2532YB	2032	pink/black
2033YB-A	2533YB	2033	light blue/black
2034YB-A	2534YB	2034	red/black
2035YB-A	2535YB	2035	grass green/black

MODEL NO. PRODUCT
[see chart] Alternate Color Label Rolls

500 labels per roll in dispenser box.

[see chart] Alternate Color Book Pages

405 labels in polybag, three-hole punched.

Jeter Year Labels Mylar Rolls

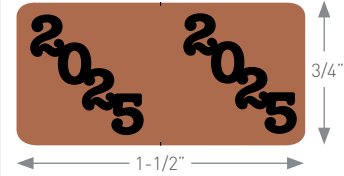

MODEL NO. ROLLS	YEAR	COLOR (bkgnd/type)
2020YB-R	2020	magenta/black
2021YB-R	2021	seafoam green/white
2022YB-R	2022	dark blue/white
2023YB-R	2023	light mint/black
2024YB-R	2024	lavender/black
2025YB-R	2025	copper/black
2026YB-R	2026	flourescent pink/black
2027YB-R	2027	lime green/white
2028YB-R	2028	dark green/white
2029YB-R	2029	light blue/white
2030YB-R	2030	magenta/black
2031YB-R	2031	seafoam green/white
2032YB-R	2032	dark blue/white
2033YB-R	2033	light mint/black
2034YB-R	2034	lavender/black
2035YB-R	2035	copper/black

MODEL NO. PRODUCT
[see chart] Year Label Rolls

500 labels per roll in dispenser box.

Jeter Top Code Year Labels Non-Mylar Pages

MODEL NO. PAGES	YEAR	COLOR (bkgnd/type)
7520YB	2020	dark bkue/white
7521YB	2021	yellow/black
7522YB	2022	red/black
7523YB	2023	purple/black
7524YB	2024	gold/black
7525YB	2025	black/white
7526YB	2026	orange/black
7527YB	2027	white/black
7528YB	2028	teal/white
7529YB	2029	gray/white
7530YB	2030	dark bkue/white
7531YB	2031	yellow/black
7532YB	2032	red/black
7533YB	2033	purple/black
7534YB	2034	gold/black
7535YB	2035	black/white

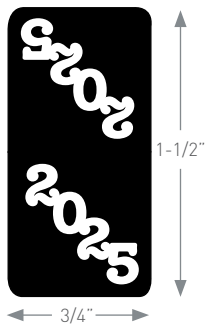

MODEL NO. PRODUCT
[see chart] Book Pgs. - Top Coder Labels

For use with drawer file systems. In pages only, 400 labels per polybag.

Jeter Month/Year Labels Mylar Pages

MODEL NO. PAGES	MONTH/YEAR	MONTH COLOR
22401MY	Jan. 2025	pink
22402MY	Feb. 2025	orange
22403MY	Mar. 2025	yellow
22404MY	Apr. 2025	light blue
22405MY	May 2025	gray
22406MY	June 2025	green
22407MY	July 2025	red
22408MY	Aug. 2025	light pink
22409MY	Sept. 2025	light green
22410MY	Oct. 2025	purple
22411MY	Nov. 2025	orange
22412MY	Dec. 2025β	brown

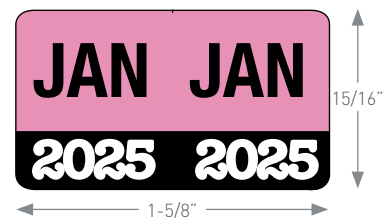

MODEL NO. PRODUCT

22491MY Month/Year Page Set
Complete set of 2024 Month/Year Codes. 12 packages, 2,700 labels.

[see chart] Month/Year Page Labels
These labels color-code the month and year for the dating of records, simplifying purging. Month/Year coding is also used for recall system. Nine labels per sheet, 225 like labels per polybag. Order individual Month/Year packages or a complete 12.

22413MY Month/Year Convenience Pack
2024 Month/Year Labels. 18 labels for each month of the year. 216 labels total. For stock number, use the first and last digits of year followed by number 21MY.

Labels – Month/Year

Jeter Year Labels Mylar Rolls - AMES Match

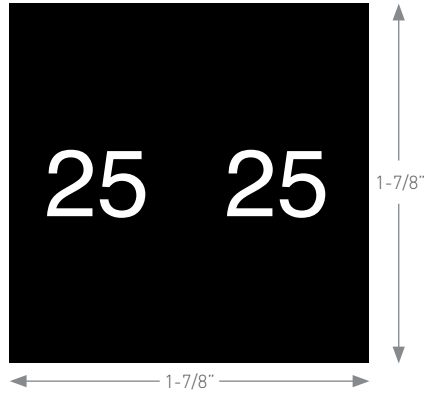

MODEL NO. ROLLS	YEAR	COLOR (bkgnnd/type)
L-A-DD20R178	2020	red
L-A-DD21R178	2021	gray
L-A-DD22R178	2022	blue
L-A-DD23R178	2023	orange
L-A-DD24R178	2024	purple
L-A-DD25R178	2025	black
L-A-DD26R178	2026	yellow
L-A-DD27R178	2027	brown
L-A-DD28R178	2028	pink
L-A-DD29R178	2029	green
L-A-DD30R178	2030	red
L-A-DD31R178	2031	gray
L-A-DD32R178	2032	blue
L-A-DD33R178	2033	orange
L-A-DD34R178	2034	purple
L-A-DD35R178	2035	black

MODEL NO.	PRODUCT
(see chart)	Ames Match Year Label Rolls 500 labels per roll in dispenser box.

Jeter Month/Year Labels Mylar Pages

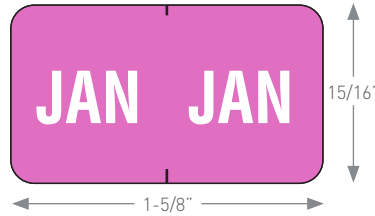

MODEL NO. PAGES	MONTH	COLOR
0001	Jan.	pink
0002	Feb.	red
0003	Mar.	yellow
0004	April	lavender
0005	May	orange
0006	June	green
0007	July	blue
0008	Aug.	black
0009	Sept.	dark blue
0010	Oct.	white
0011	Nov.	purple
0012	Dec.	gold

MODEL NO.	PRODUCT
0013	Month Page Set Complete Month Code Set. Includes a binder with indexes January through December. Five pages of 24 labels, January through December, for a total of 1,440 labels.
(see chart)	Month Page Labels All new colors are available for this important series of month labels. Best used with the new Birth Date systems. Packaged in pages, 240 like labels per polybag.

Jeter Month/Year Labels Mylar Pages

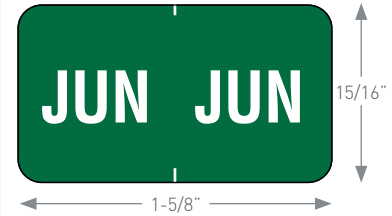

MODEL NO. PAGES	MONTH	COLOR
7001	Jan.	lavender
7002	Feb.	light orange
7003	Mar.	yellow
7004	April	blue
7005	May	gray
7006	June	green
7007	July	red
7008	Aug.	salmon
7009	Sept.	light green
7010	Oct.	purple
7011	Nov.	dark orange
7012	Dec.	brown

MODEL NO.	PRODUCT
7091	Month Sheet Set Complete Month Code Set. 12 packages – 7001 thru 7012. 2,700 labels
(see chart)	Month Pages Labels For coding all 12 months each with its own color. Colors are the same as in Month/Year Codes. Order individual month or complete sets, January through December. 9 sheets, 225 like labels per polybag.
7091	Month Convenience Pack Package of label sheets. 18 labels for each month of the year. 216 labels total.

Labels – Month/Year

AMES Month/Year Code Labels

- Size: 1" x 1-3/4"
- Polyester laminated for added durability.
- Scored to center and fold easily.
- Permanent adhesive and release coated paper backing.
- Labels come in rolls.

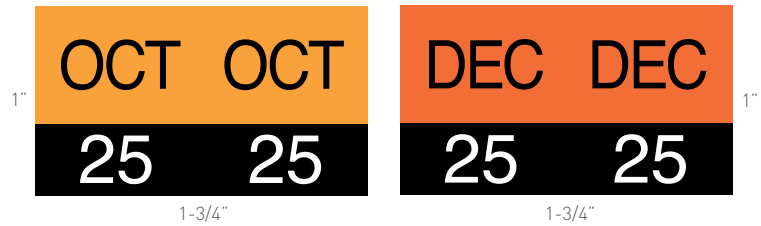

2024 (Purple)	2025 (Black)	2026 (Yellow)	2027 (Brown)	2028 (Pink)		
ITEM NUMBER	ITEM NUMBER	ITEM NUMBER	ITEM NUMBER	ITEM NUMBER	MONTH COLOR	MONTH
L-A-MY-JAN24	L-A-MY-JAN25	L-A-MY-JAN26	L-A-MY-JAN27	L-A-MY-JAN28	AMES Gray	January
L-A-MY-FEB24	L-A-MY-FEB25	L-A-MY-FEB26	L-A-MY-FEB27	L-A-MY-FEB28	AMES Blue	February
L-A-MY-MAR24	L-A-MY-MAR25	L-A-MY-MAR26	L-A-MY-MAR27	L-A-MY-MAR28	AMES Green	March
L-A-MY-APR24	L-A-MY-APR25	L-A-MY-APR26	L-A-MY-APR27	L-A-MY-APR28	AMES Purple	April
L-A-MY-MAY24	L-A-MY-MAY25	L-A-MY-MAY26	L-A-MY-MAY27	L-A-MY-MAY28	White	May
L-A-MY-JUN24	L-A-MY-JUN25	L-A-MY-JUN26	L-A-MY-JUN27	L-A-MY-JUN28	AMES Yellow	June
L-A-MY-JUL24	L-A-MY-JUL25	L-A-MY-JUL26	L-A-MY-JUL27	L-A-MY-JUL28	AMES Brown	July
L-A-MY-AUG24	L-A-MY-AUG25	L-A-MY-AUG26	L-A-MY-AUG27	L-A-MY-AUG28	AMES Pink	August
L-A-MY-SEP24	L-A-MY-SEP25	L-A-MY-SEP26	L-A-MY-SEP27	L-A-MY-SEP28	AMES Black	September
L-A-MY-OCT24	L-A-MY-OCT25	L-A-MY-OCT26	L-A-MY-OCT27	L-A-MY-OCT28	AMES Orange	October
L-A-MY-NOV24	L-A-MY-NOV25	L-A-MY-NOV26	L-A-MY-NOV27	L-A-MY-NOV28	Aqua	November
L-A-MY-DEC24	L-A-MY-DEC25	L-A-MY-DEC26	L-A-MY-DEC27	L-A-MY-DEC28	AMES Red	December
L-A-MY-ST24	L-A-MY-ST25	L-A-MY-ST26	L-A-MY-ST27	L-A-MY-ST28	Label Set	Jan.-Dec.

Individual Rolls

MODEL NO.	LBS./UNIT	QUANTITY
See above	1 lb.	roll of 1000

Label Sets (1 roll of each month)

MODEL NO.	LBS./UNIT	QUANTITY
See above	12 lbs.	1 set of 12 rolls

AMES Month Labels

- Size: 9/16" x 1-3/4"
- Scored to center and fold easily.
- Polyester laminated for added durability.
- Labels come in rolls.
- Permanent adhesive; release coated paper backing.



Individual Rolls

MODEL NO.	LBS./UNIT	QUANTITY
See right	1/2 lb.	roll of 1000

Label Sets (1 roll of each month)

L-A-MST	6 lbs.	1 set of 12 rolls
---------	--------	-------------------

MODEL NO.	MONTH COLOR	MONTH
L-A-MJAN	AMES Grey	January
L-A-MFEB	AMES Blue	February
L-A-MMAR	AMES Green	March
L-A-MAPR	AMES Purple	April
L-A-MMAY	White	May
L-A-MJUN	AMES Yellow	June
L-A-MJUL	AMES Brown	July
L-A-MAUG	AMES Pink	August
L-A-MSEP	AMES Black	September
L-A-MOCT	AMES Orange	October
L-A-MNOV	Aqua	November
L-A-MDEC	AMES Red	December
L-A-MST	Label Set	Jan.-Dec.

Label Organizer Box

Label organizer box holds individual boxes for organizing CompuColor, AlphaCode, Classification, Year, Month, Solid and Color-Bar labels.

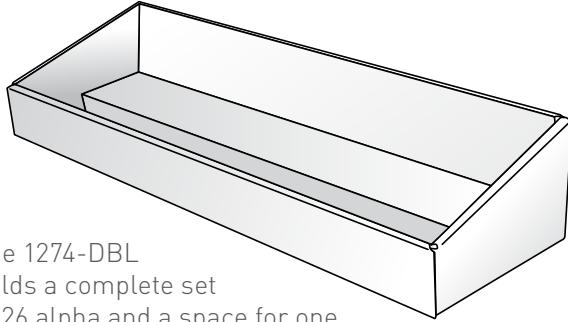

The 1274-DBL holds a complete set of 26 alpha and a space for one additional box to add a year label or the Mc label.

MODEL NO.	DESCRIPTION	QUANTITY
1274-DBL	Double Organizer Box	1

*(1) Organizer box included at N/C with each label set purchased.

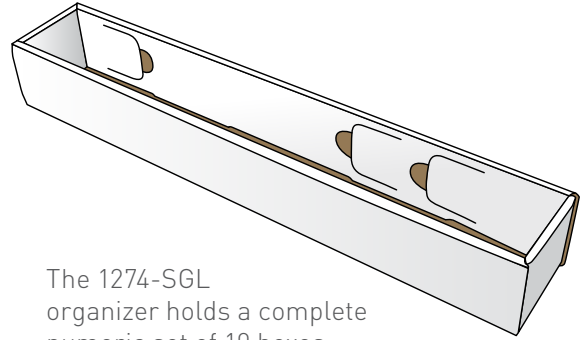

The 1274-SGL organizer holds a complete numeric set of 10 boxes.

MODEL NO.	DESCRIPTION	QUANTITY
1274-SGL	Single Organizer Box	1

*(1) Organizer box included at N/C with each label set purchased.

Label Protectors

Extend your shelf life with clear wrap around self adhesive label protectors.

MODEL NO.	DESCRIPTION	QUANTITY
4400-00	2" w x 4" h	500/pkg
4401-00	2" w x 8" h	100/pkg

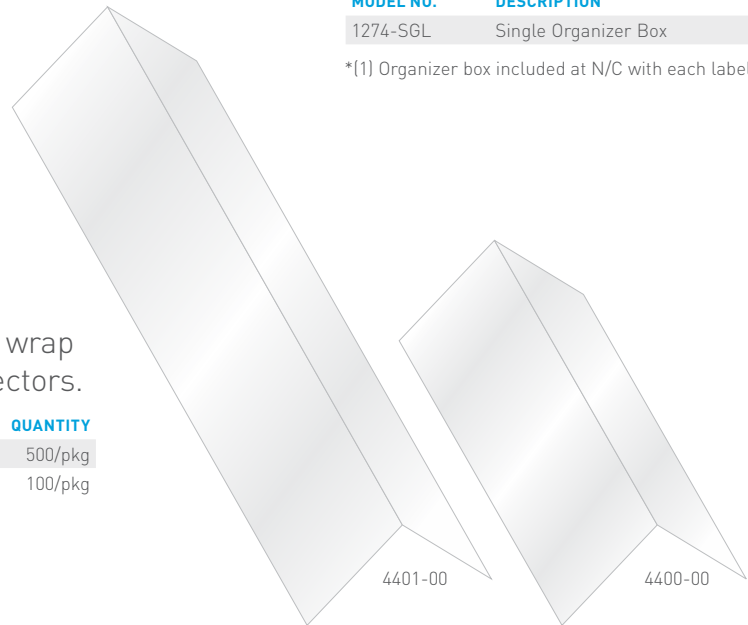

8853-G

Label-Lam Mylar Overlays

MODEL NO.	DESCRIPTION	QUANTITY.
8853-G	Label Lam Mylar Overlay, Indexing Labels Protection, 2" H x 3¼" W	250/pkg

Retired Items

Jeter Standard End Tab File Folders

Letter Size, Standard Tab Folders – 12-1/4" W x 9-1/2" H

OLD MODEL NO.	CURRENT MODEL NO.	SEE PAGE
J1131	1102-00	4
J1231	1128-00	4
J1050	1103-50	4
J1241	1123-00	4

Legal Size, Standard End Tab Folders – 15-1/4" W x 9-1/2" H

OLD MODEL NO.	CURRENT MODEL NO.	SEE PAGE
J1431	1118-00	4

Jeter Top Tab and End Tab Reinforced Folders

Letter Size – 12" W x 9-9/16" H

OLD MODEL NO.	CURRENT MODEL NO.	SEE PAGE
J1261	1344-00	10
J1461	1347-00	10

GBS Letter Size Manila Folders

Letter Size, 12-1/4" W x 9-1/2" H

OLD MODEL NO.	CURRENT MODEL NO.	SEE PAGE
8683	1102-00	4
8685	1128-00	4
8668	1141-00	4
8687	1103-00	4
8688	1123-00	4

Legal Size, 15-1/4" W x 9-1/2" H

OLD MODEL NO.	CURRENT MODEL NO.	SEE PAGE
8684	1104-00	4
8686	1118-00	4
8689	1105-50	4
8690	1127-00	4

GBS Manila Pocket Folders

One Piece, Built in Pocket with Flap, 12-1/4" W x 9-1/2" H

OLD MODEL NO.	CURRENT MODEL NO.	SEE PAGE
8614	1139-00	28

GBS AMES Match Manila Folders

Reinforced Tab, 12-1/8" W x 9-1/2" H

OLD MODEL NO.	CURRENT MODEL NO.	SEE PAGE
8791	OCFV-A	8
8795	OCFV-A15	8

GBS Barkley Match Manila Folders

Reinforced Tab, 12-1/4" W x 9-1/2" H

OLD MODEL NO.	CURRENT MODEL NO.	SEE PAGE
9287	1103-50	4
9288	1123-00	4

AMES Dental Patient Pocket Folders

11 Pt. Manila Stock, Pocket Size 12-1/4" W x 9-3/8" H

OLD MODEL NO.	CURRENT MODEL NO.	SEE PAGE
DDS-FLD2	1139-00B13	28

Label-Lam Mylar Overlays

2" W x 8" H

OLD MODEL NO.	CURRENT MODEL NO.	SEE PAGE
8941	4401-00	77

AMES - Jeter® Style 7200 Series Alpha Labels

OLD MODEL NO.	CURRENT MODEL NO.	SEE PAGE
L-J-ALPHA-A	7250	56
L-J-ALPHA-B	7251	56
L-J-ALPHA-C	7252	56
L-J-ALPHA-D	7253	56
L-J-ALPHA-E	7254	56
L-J-ALPHA-F	7255	56
L-J-ALPHA-G	7256	56
L-J-ALPHA-H	7257	56
L-J-ALPHA-I	7258	56
L-J-ALPHA-J	7259	56
L-J-ALPHA-K	7260	56
L-J-ALPHA-L	7261	56
L-J-ALPHA-MC	7263	56
L-J-ALPHA-M	7262	56
L-J-ALPHA-N	7264	56
L-J-ALPHA-O	7265	56
L-J-ALPHA-P	7266	56
L-J-ALPHA-Q	7267	56
L-J-ALPHA-R	7268	56
L-J-ALPHA-S	7269	56
L-J-ALPHA-T	7270	56
L-J-ALPHA-U	7271	56
L-J-ALPHA-V	7272	56
L-J-ALPHA-W	7273	56
L-J-ALPHA-X	7274	56
L-J-ALPHA-Y	7275	56
L-J-ALPHA-Z	7276	56

Retired Items

AMES - TAB® Style 7200 Series Alpha Labels

OLD MODEL NO.	CURRENT MODEL NO.	SEE PAGE
L-T-ALPHA-A	1283-A	54
L-T-ALPHA-B	1283-B	54
L-T-ALPHA-C	1283-C	54
L-T-ALPHA-D	1283-D	54
L-T-ALPHA-E	1283-E	54
L-T-ALPHA-F	1283-F	54
L-T-ALPHA-G	1283-G	54
L-T-ALPHA-H	1283-H	54
L-T-ALPHA-I	1283-I	54
L-T-ALPHA-J	1283-J	54
L-T-ALPHA-K	1283-K	54
L-T-ALPHA-L	1283-L	54
L-T-ALPHA-M	1283-M	54
L-T-ALPHA-MC	1283-MC	54
L-T-ALPHA-N	1283-N	54
L-T-ALPHA-O	1283-O	54
L-T-ALPHA-P	1283-P	54
L-T-ALPHA-Q	1283-Q	54
L-T-ALPHA-R	1283-R	54
L-T-ALPHA-S	1283-S	54
L-T-ALPHA-T	1283-T	54
L-T-ALPHA-U	1283-U	54
L-T-ALPHA-V	1283-V	54
L-T-ALPHA-W	1283-W	54
L-T-ALPHA-X	1283-X	54
L-T-ALPHA-Y	1283-Y	54
L-T-ALPHA-Z	1283-Z	54

NOTE: If you have previously purchased the **AMES TAB® Style** labels shown below;



L-T-ALPHA-F
(yellow)



L-T-ALPHA-MC
(brown)



L-T-ALPHA-O
(yellow)

These labels are still available.

Please continue to use the old Model numbers when placing your order.

GBS - Series 3100 Paper Rolls TAB Match

OLD MODEL NO.	CURRENT MODEL NO.	SEE PAGE
3150	1283-A	54
3151†	1283-B	54
3152	1283-C	54
3153	1283-D	54
3154	1283-E	54
3155*	1283-F	54
3156**	3156**	54
3157	1283-G	54
3158	1283-H	54
2159	1283-I	54
3160	1283-J	54
3161	1283-K	54
3162	1283-L	54
3163	3163	54
3164	1283-M	54
3165	1283-N	54
3166	1283-O	54
3167**	3167**	54
3168	1283-P	54
3169	1283-Q	54
3170	1283-R	54
3171	1283-S	54
3172	1283-T	54
3173‡	1283-U	54
3174	1283-V	54
3175	1283-W	54
3176	1283-X	54
3177	1283-Y	54
3178	1283-Z	54
3190	1283-50	54

NOTE: If you have previously purchased the **GBS TAB® Match** labels shown below;



3156**



3163



3167**

These labels are still available.

Please continue to use the old Model numbers when placing your order.

GBS - Series 3200 Kimdura Rolls TAB Match

OLD MODEL NO.	CURRENT MODEL NO.	SEE PAGE
3250	1283-A	54
3251†	1283-B	54
3252	1283-C	54
3253	1283-D	54
3254	1283-E	54
3255	1283-F	54
3257	1283-G	54
3258	1283-H	54
2259	1283-I	54
3260	1283-J	54
3261‡	1283-K	54
3262	1283-L	54
3263	3163-MC	54
3264	1283-M	54
3265	1283-N	54
3266	1283-O	54
3268	1283-P	54
3269	1283-Q	54
3270	1283-R	54
3271	1283-S	54
3272	1283-T	54
3273‡	1283-U	54
3274	1283-V	54
3275	1283-W	54
3276	1283-X	54
3277	1283-Y	54
3278	1283-Z	54
3291	1283-50	54

Retired Items

GBS - Series 3600/6500 Rolls/Pages TAB Match

OLD MODEL NO. ROLLS/PAGES	CURRENT MODEL NO. ROLLS/PAGES	SEE PAGE ROLLS/PAGES
3650/6510	1283-A/1286-A	54/59
3651/6511	1283-B/1286-B	54/59
3652/6512	1283-C/1286-C	54/59
3653/6513	1283-D/1286-D	54/59
3654/6514	1283-E/1286-E	54/59
3655/6515	1283-F/1286-F	54/59
3657/6516	1283-G/1286-G	54/59
3658/6517	1283-H/1286-H	54/59
3659/6518	1283-I/1286-I	54/59
3660/6519	1283-J/1286-J	54/59
3661/6520	1283-K/1286-K	54/59
3662/6521	1283-L/1286-L	54/59
3663/6522	1283-MC/1286-MC	54/59
3664/6523	1283-M/1286-M	54/59
3665/6524	1283-N/1286-N	54/59
3666/6525	1283-O/1286-O	54/59
3668/6526	1283-P/1286-P	54/59
3669/6527	1283-Q/1286-Q	54/59
3670/6528	1283-R/1286-R	54/59
3671/6529	1283-S/1286-S	54/59
3672/6530	1283-T/1286-T	54/59
3673/6531	1283-U/1286-U	54/59
3674/6532	1283-V/1286-V	54/59
3675/6533	1283-W/1286-W	54/59
3676/6534	1283-X/1286-X	54/59
3677/6535	1283-Y/1286-Y	54/59
3678/6536	1283-Z/1286-Z	54/59

GBS - Series 5100 Mylar Rolls TAB Match

OLD MODEL NO. ROLLS	CURRENT MODEL NO. ROLLS	SEE PAGE
5150	1283-A	54
5151	1283-B	54
5152	1283-C	54
5153	1283-D	54
5154	1283-E	54
5155*	1283-F	54
L-T-ALPHA-F	L-T-ALPHA-F	54
5157	1283-G	54
5158	1283-H	54
5159	1283-I	54
5160	1283-J	54
5161	1283-K	54
5162	1283-L	54
L-T-ALPHA-MC	L-T-ALPHA-MC	54
5164	1283-M	54
5165	1283-N	54
5166*	1283-O	54
L-T-ALPHA-O	L-T-ALPHA-O	54
5168	1283-P	54
5169	1283-Q	54
5170	1283-R	54
5171	1283-S	54
5172	1283-T	54
5173	1283-U	54
5174	1283-V	54
5175	1283-W	54
5176	1283-X	54
5177	1283-Y	54
5178	1283-Z	54

Jeter - Series 0600 Mylar Rolls TAB Match

OLD MODEL NO. ROLLS	CURRENT MODEL NO. ROLLS	SEE PAGE
0650	1278-A	53
0651	1278-B	53
0652	1278-C	53
0653	1278-D	53
0654	1278-E	53
0655	1278-F	53
0657	1278-G	53
0658	1278-H	53
0659	1278-I	53
0660	1278-J	53
0661	1278-K	53
0662	1278-L	53
0664	1278-M	53
0665	1278-N	53
0666	1278-O	53
0668	1278-P	53
0669	1278-Q	53
0670	1278-R	53
0671	1278-S	53
0672	1278-T	53
0673	1278-U	53
0674	1278-V	53
0675	1278-W	53
0676	1278-X	53
0677	1278-Y	53
0678	1278-Z	53
0691	1278-50	53
	TAB Match	
	Mini Roll Set	

NOTE: If you have previously purchased the **GBS TAB® Match** labels shown below;



L-T-ALPHA-F L-T-ALPHA-MC L-T-ALPHA-O

These labels are still available.

Please continue to use the old Model numbers when placing your order.

Retired Items

Jeter - Series 9400 Rolls - GBS Match

OLD MODEL NO. ROLLS	CURRENT MODEL NO. ROLLS	SEE PAGE
9450	8850-A	59
9451	8850-B	59
9452	8850-C	59
9453	8850-D	59
9454	8850-E	59
9455	8850-F	59
9456	8850-G	59
9457	8850-H	59
9458	8850-I	59
9459	8850-J	59
9460	8850-K	59
9461	8850-L	59
9462	8850-Mc	59
9463	8850-M	59
5164	8850-N	59
5165	8850-O	59
5166	8850-P	59
5167	8850-Q	59
5168	8850-R	59
5169	8850-S	59
5170	8850-T	59
5171	8850-U	59
5172	8850-V	59
5173	8850-W	59
5174	8850-X	59
5175	8850-Y	59
5176	8850-Z	59

AMES - Full Size Numeric Labels TAB® Style

OLD MODEL NO.	CURRENT MODEL NO.	SEE PAGE
L-T-00158	1282-00	61
L-T-01158	1282-01	61
L-T-02158	1282-02	61
L-T-03158	1282-03	61
L-T-04158	1282-04	61
L-T-05158	1282-05	61
L-T-06158	1282-06	61
L-T-07158	1282-07	61
L-T-08158	1282-08	61
L-T-09158	1282-09	61
L-T-ST158	1282-50	61

AMES - Series 7300 Numeric Jeter® Style

OLD MODEL NO.	CURRENT MODEL NO.	SEE PAGE
L-J-00158	7380	61
L-J-01158	7371	61
L-J-02158	7372	61
L-J-03158	7373	61
L-J-04158	7374	61
L-J-05158	7375	61
L-J-06158	7376	61
L-J-07158	7377	61
L-J-08158	7378	61
L-J-09158	7379	61

GBS - Series 3700 Mylar Rolls - TAB Match

OLD MODEL NO.	CURRENT MODEL NO.	SEE PAGE
3771	1282-01	61
3772	1282-02	61
3773	1282-03	61
3774	1282-04	61
3775	1282-05	61
3776	1282-06	61
3777	1282-07	61
3778	1282-08	61
3779	1282-09	61
3780	1282-00	61
3790	1282-50	61

GBS - Series 4100 Non-Mylar Rolls - TAB Match

OLD MODEL NO.	CURRENT MODEL NO.	SEE PAGE
4171	1282-01	61
4172	1282-02	61
4173	1282-03	61
4174	1282-04	61
4175	1282-05	61
4186	4186	61
4176	1282-06	61
4177	1282-07	61
4178	1282-08	61
4179	1282-09	61
4180	1282-00	61
4171/4180	1282-50	61

NOTE: If you have previously purchased the **GBS TAB® Match** label shown below;



4186

This label is still available.
Please continue to use the old
Model number when placing your order.

GBS - Series 4200 Kimdura Rolls - TAB Match

OLD MODEL NO.	CURRENT MODEL NO.	SEE PAGE
4271	1282-01	61
4272	1282-02	61
4273	1282-03	61
4274	1282-04	61
4275	1282-05	61
4276	1282-06	61
4277	1282-07	61
4278	1282-08	61
4279	1282-09	61
4280	1282-00	61
4290	1282-50	61

Jeter - Series 6100 Mylar Rolls - TAB Match

OLD MODEL NO.	CURRENT MODEL NO.	SEE PAGE
6171	1282-01	61
6172	1282-02	61
6173	1282-03	61
6174	1282-04	61
6175	1282-05	61
6186	6186	61
6176	1282-06	61
6177	1282-07	61
6178	1282-08	61
6179	1282-09	61
6180	1282-00	61
6191/6190	1282-50	61

NOTE: If you have previously purchased the **GBS TAB® Match** label shown below;



6186

This label is still available.
Please continue to use the old
Model number when placing your order.

Jeter - Series 0700 Non-Mylar Rolls - TAB Match

OLD MODEL NO.	CURRENT MODEL NO.	SEE PAGE
0771	1277-01	61
0772	1277-02	61
0773	1277-03	61
0774	1277-04	61
0775	1277-05	61
0776	1277-06	61
0777	1277-07	61
0778	1277-08	61
0779	1277-09	61
0780	1277-00	61
0791	1282-50	61

Retired Items

Jeter - Series 4400

Non-Mylar Rolls - TAB Match

OLD MODEL NO.	CURRENT MODEL NO.	SEE PAGE
0771	1277-01	61
0772	1277-02	61
0773	1277-03	61
0774	1277-04	61
0775	1277-05	61
0776	1277-06	61
0777	1277-07	61
0778	1277-08	61
0779	1277-09	61
0780	1277-00	61
4491	1282-50	61

Jeter - Series 6000

Mylar Rolls - DATAFILE Match

OLD MODEL NO.	CURRENT MODEL NO.	SEE PAGE
6001	L8700-1	62
6002	L8700-2	62
6003	L8700-3	62
6004	L8700-4	62
6005	L8700-5	62
6006	L8700-6	62
6007	L8700-7	62
6008	L8700-8	62
6009	L8700-9	62
6010	L8700-0	62
6011	L8706	62

Jeter - Series 9400

Mylar Rolls - GBS Match

OLD MODEL NO.	CURRENT MODEL NO.	SEE PAGE
9401	8860-1	
9402	8860-2	
9403	8860-3	
9504	8860-4	
9405	8860-5	
9406	8860-6	
9407	8860-7	
9408	8860-8	
9409	8860-9	
9400	8860-0	
9410	8860-Set	

Jeter - Series 9500

Mylar Rolls - AMES Match

OLD MODEL NO.	CURRENT MODEL NO.	SEE PAGE
9501	L-A-01178RLP	63
9502	L-A-02178RLP	63
9503	L-A-03178RLP	63
9504	L-A-04178RLP	63
9505	L-A-05178RLP	63
9506	L-A-06178RLP	63
9507	L-A-07178RLP	63
9508	L-A-08178RLP	63
9509	L-A-09178RLP	63
9500	L-A-00178RLP	63
9510	L-A-ST178RLP	63

Jeter - Series 9500-A

Non-Mylar Rolls - AMES Match

OLD MODEL NO.	CURRENT MODEL NO.	SEE PAGE
9501-A	L-A-01178RLP	63
9502-A	L-A-02178RLP	63
9503-A	L-A-03178RLP	63
9504-A	L-A-04178RLP	63
9505-A	L-A-05178RLP	63
9506-A	L-A-06178RLP	63
9507-A	L-A-07178RLP	63
9508-A	L-A-08178RLP	63
9509-A	L-A-09178RLP	63
9500-A	L-A-00178RLP	63
9510-A	L-A-ST178RLP	63

Jeter - Series 4600

Mylar Rolls

OLD MODEL NO.	CURRENT MODEL NO.	SEE PAGE
4600	DD0550-00	65
4610	DD0550-10	65
4620	DD0550-20	65
4630	DD0550-30	65
4640	DD0550-40	65
4650	DD0550-50	65
4660	DD0550-60	65
4670	DD0550-70	65
4680	DD0550-80	65
4690	DD0550-90	65

Jeter - Year Labels

Mylar Rolls - AMES Match

OLD MODEL NO.	CURRENT MODEL NO.	SEE PAGE
2020YBAX	L-A-DD20R178	75
2021YBAX	L-A-DD20R178	75
2022YBAX	L-A-DD22R178	75
2023YBAX	L-A-DD23R178	75
2024YBAX	L-A-DD24R178	75
2025YBAX	L-A-DD25R178	75
2026YBAX	L-A-DD26R178	75
2027YBAX	L-A-DD27R178	75
2028YBAX	L-A-DD28R178	75
2029YBAX	L-A-DD29R178	75
2030YBAX	L-A-DD30R178	75
2031YBAX	L-A-DD31R178	75
2032YBAX	L-A-DD32R178	75
2033YBAX	L-A-DD33R178	75
2034YBAX	L-A-DD34R178	75
2035YBAX	L-A-DD35R178	75

TAB Terms & Policies



48 Hours is the usual time it takes for us to ship your stock supply purchase. Most are shipped the day after you place your order. Call TAB Express for delivery times on custom products and next day deliveries.



When calling TAB, your call be answered by a Filing Expert that can assist you with all your filing queries.



Manila, Color and Kraft Material:

11,14, and 18 point manila 10% Post-consumer waste (PCW)
11 and 14 point color 30% Post-consumer waste (PCW)
11 and 17 point Kraft 10% Post-consumer waste (PCW)

Pressboard Material:

Type II 60% recycled 30% Post-consumer waste (PCW)

Red-Rope Expansion Pockets: 30% Recycled, 10% PCW

Our shipping cartons consist of 65% virgin, 30% post-consumer waste, and 5% pre-consumer waste. Our internal folder boxes have recycled cellulose content of 65% post-consumer and 35% pre-consumer waste.

All adhesive products have a limited shelf life. We recommend that you purchase only the quantity that will be used within 12 months.

TERMS: Net 30 days from invoice and ship date. Prices are FOB TAB's facility in Mayville, Wisconsin and are subject to change without notice. Minimum Order Quantity: Made-To-Order products, printed products and labeled products have minimum quantities so orders below these minimums will also be up charged to meet the minimum quantity value. Split Box Shipments: Returns and cancellations must be pre-approved by calling 1-888-466-8228. Returns for standard product only must be processed within 30 days of shipment and will be assessed a 20% restocking fee. The merchandise must be shipped freight prepaid in its original packaging and be in resaleable condition. The merchandise will be inspected upon receipt.

Custom products are not returnable.

TAB reserves the right to correct any typographical errors.

NOTE: The colors represented in this catalog are as close as possible to actual TAB product colors within the limits of modern graphic processes. Minimum order \$100.00.



TAB accepts MasterCard, Visa, Discover and American Express cards for quick account set up.

Over Run & Under Run Policy: We attempt to ship exact quantities as ordered; however, we reserve the right to over-ship or under-ship a maximum of 10% on custom manufactured or printed items. On custom supplies requiring factory attached color-coded labels, the exact quantity of labels will be applied which frequently results in leftover custom folders. The excess folders will ship with the order with no label applied. Billing will reflect the quantity produced and shipped.

Environmental Policy Statement

Our environment has become a subject of increasing importance in the world. TAB recognizes the importance of a sustainable earth and believes it is the responsibility of every person and every enterprise to set a standard for sustainability by assessing the impact of their business practices on our environment and implementing sound policies throughout their process and daily operations.

TAB has committed itself to reduce impacts on the environment and operating costs through pollution prevention activities. Through more proficient manufacturing methods and

investments in our facilities, we have seen reduction in material wastes, minimal air emissions and improvements in wastewater pre-treatment.

We consider the environmental impact of procedures throughout all facets of operation including, but not limited to purchasing, engineering, material handling, processing, manufacturing and transportation.

We incorporate best management practices into every decision-making process to reduce pollution to the minimum levels technically and economically feasible, while achieving

or exceeding compliance with all State and Federal regulations and increasing productivity, quality and value.

We continually renew the commitment to excellence and leadership in protecting the environment by using the basic principles of pollution prevention, waste minimization, waste elimination and recycling.

TAB's products are manufactured to meet and exceed environmental standards and provide a long useful life. Our suppliers are also selected according to these same friendly environmental practices

criteria. Our steel and paper suppliers use recyclable material content.

Our packaging department uses minimal amount of cardboards and whenever possible shrink wrap all the materials while ensuring that the products are safely protected when in transit to our customers.

TAB is committed to achieving a sustainable harmony with our global environment. Continuous commitments and improvements in providing adaptable workspace solutions with high-quality products are the foundations of our company.

Index – Folders and Other Supplies

MODEL NO.	PAGE	MODEL NO.	PAGE	MODEL NO.	PAGE	MODEL NO.	PAGE
1000PKC100	43	1187-00	30	1346-00	10	1635-108	40
1000PKE100	43	1189-**	30	1347-00	10	1635-111	40
1100-**	51	1189-00	30	1348-**	12	1635-116	40
1102-00	4	1191-**	30	1348-00	21	1635-123	40
1103-50	4	1191-00	30	1349-**	12	1635-125	40
1104-00	4	1193-**	30	1349-00	21	1635-147	40
1105-50	4	1193-00	30	1350-**	12	1635-150	40
1106-**	11	1196-00	22	1350-00	21	1635-151	40
1108-00	42	1197-00	22	1351-**	12	1635-153	40
1108-01	15	1211-**	11	1351-00	21	2-XOG-R	45
1111-00	9	1212-**	11	1352-**B	12	2220	44
1112-00	9	1214-**	11	1352-00B	19	2240	44
1114-00	9	1222-**	11	1353-**B	12	2250	44
1118-00	4	1235-**	12	1353-00B	19	2CFV	36
1119-00	5	1235-00	21	1354-**B	12	2CFV-ST	36
1120-**	51	1236-**	12	1354-00B	19	2CFV15	36
1122-00	9	1236-00	21	1355-**B	12	2CFV15-ST	36
1123-00	4	1237-00B	21	1355-00B	19	4302-01	47
1126-**	11	1238-00B	21	1379-**	30	4302-50	44
1127-00	4	1243-**B	12	1381-**	30	4302-DPT	47
1128-00	4	1243-00B	19	1389-00	30	4308-75	52
1129-00	5	1244-**B	12	1390-00	30	4333-00	45
1130-00	31	1244-00B	19	1394-00	30	4343-00	45
1131-00	31	1245-**B	12	1396-00	30	4345-00	45
1132-00	31	1245-00B	19	1397-00	30	4348-00	45
1133-00	31	1246-**B	12	1398-00	30	4349-00	18
1139-00	28	1246-00B	19	1401-00	30	4354-50	5
1139-00B13	28	1247-**B	12	1406-**	11	4357-13	5
1141-00	4	1247-00B	19	1426-**	11	4366-**	51
1142-00	4	1248-**B	12	1454-**B	12	4367-**	51
1157-00	9	1248-00B	19	1454-00B	12	4368-00	52
1157-C	9	1249-00B	21	1456-**B	12	4370-00	51
1157-L	9	1250-**	12	1456-00B	12	4387-**	30
1157-R	9	1250-00	21	1631	47	4388-00	51
1158-00	9	1251-**	12	1632	47	4397-**	30
1158-C	9	1251-00	21	1635-001	40	4400-00	40
1158-L	9	1252-00B	21	1635-002	40	4401-00	40
1158-R	9	1253-00B	21	1635-003	40	5050-00	5
1159-00	44	1254-**B	12	1635-004	40	5050-OT	5
1160-00	44	1254-00B	12	1635-005	40	5100-00	5
1161-00	44	1255-**	12	1635-008	40	5100-OT	5
1162-**	14	1255-00	12	1635-009	40	5150-00	5
1163-**	14	1256-**B	12	1635-010	40	5260-OT	5
1165-01	48	1256-00B	12	1635-011	40	700002	43
1165-02	48	1257-**	12	1635-012	40	8600	28
1166-**	29	1257-00	12	1635-013	40	8601	28
1168-00	26	1258-00B	20	1635-014	40	8607	28
1169-00	26	1259-00B	20	1635-021	40	8611	28
1172-**	29	1268-00B	20	1635-023	40	8631	49
1174-**	29	1269-00B	20	1635-026	40	8635	49
1175-00	26	13-411L	44	1635-027	40	8654	20
1176-00	26	1303-90	30	1635-033	40	8661	13
1177-00	33	1317-00	4	1635-034	40	8662	8
1177-25	33	1318-00	4	1635-035	40	8663-1	8
1177-50	33	1327-00	4	1635-037	40	8665-1	8
1177-75	33	1328-00	4	1635-043	40	8669	49
1178-00	26	1334-**	10	1635-048	40	8687C	15
1179-00	26	1335-**	10	1635-063	40	9155	23
1180-00	26	1336-**	10	1635-065	40	9185	8
1181-00	26	1337-**	10	1635-069	40	9187	8
1184-**	29	-00	10	1635-073	40	9188	8
1187-**	30	1345-00	10	1635-075	40	B	42

Index – Folders and Other Supplies

MODEL NO.	PAGE	MODEL NO.	PAGE	MODEL NO.	PAGE	MODEL NO.	PAGE
CC-MIDI-ST	34	F1752	22	J1461	10	KA-2610005R	16
CD-MD	38	F1832	31	J14900	28	KA-2620003R	18
CN101213	24	F1834	31	J14901	28	KA-2620004R	18
CN101313	24	F1842	31	J1569	7	KA-50998R	16
CN102213	24	F1844	31	J1635	46	KA-5099R	16
CN102313	24	F1852	31	J1636	46	KA-52998R	18
CN11118	24	F1854	31	J1637	46	KA-5299R	18
CN1125	48	F1870	25	J1831	9	L	49
CN1128	24	F1872	25	J1931	9	L-A-RE-POLYS	48
CN1155	48	F1952-BL	52	J2131	7	L-A-RE-POLYS3	48
CN1158	24	F1963-1	52	J2132	7	LI-FLD11	6
CN1218	24	F1965-1	52	J2141	7	LI-FLD15	6
CN1219-*	14	F5600	31	J2231	7	M	49
CN1228	24	F5610	31	J2232	10	MCXIOE-MAM-250	35
CN1229-*	14	F5650	31	J2241	7	MCXIOS-MAM-250	35
CN1258	24	F5700	31	J2241-BT	15	MCXIOS-PL-250	35
CN1259-*	14	F5750	31	J2241-BT-56	15	MIDI-ST	34
CN1844	31	F5755	31	J2241-BT-58	15	MIDI-ST-UNIV	34
CN1923	31	FAS-E-Z275A	43	J2241-BT-58	15	N=4333-00	45
COCFV	9	FAS-EZ275	43	J2241-GT	15	O=4348-00	45
CXE-DF-ST-DPKT-**	34	FAS-PERM-1L	42	J2241-GT-56	15	OCF-VNA	36
CXIOE-BN	35	FAS-PERM-2L	42	J2241-RT	15	OCFV-1P	8
CXIOE-MC	35	FF4012**13	25	J2241-RT-56	15	OCFV-2P	8
CXIOE-MRI	35	FF4013**13	25	J2241-RT-58	15	OCFV-A	8
CXIOE-PL	35	FF4022**13	25	J2241-W	32	OCFV-A15	8
CXIOS-AN	35	FF4033**13	25	J2241-YT	15	OCFV-EZ	6
CXIOS-BN	35	FF4053**13	25	J2241-YT-56	15	OCFV-EZ-15	6
CXIOS-GU	35	FF4219-**	25	J2241-YT-58	15	OCFV-ST	36
CXIOS-HN	35	FF4229-**	25	J2252B	13	OCFV15-ST	36
CXIOS-MC	35	FF4259-**	25	J2252B-56	13	OCFVX	32
CXIOS-NC	35	FF4712**13	25	J2252B-58	13	OCXE-DF-PL	33
CXIOS-PL	35	FF4722**13	25	J2252G	13	OCXE-DST	33
CZIOE-MAM	35	FF4752**13	25	J2252G-58	13	OCXE-DST-DP	34
E=70001	43	FLB-ST	40	J2252R	13	OCXE-DUO-PL	34
EZ-CMP-275	43	FLD-MD	38	J2252R-56	13	OCXE-NST	33
EZ-EXT-275	43	G	49	J2252R-58	13	OCXE-NST-DP	34
EZ275RBIC	43	H	49	J2252W	13	OPRS-ST	23
EZ275RBIM	43	J	49	J2252W-58	13	OPRS-STEZ	23
F	49	J0500	48	J2252Y	13	P	50
F1000	48	J0501	48	J2252Y-58	13	PC-OE-MMM-250	35
F101213	19	J1261	10	J2269	7	PC-OE-MUS-250	35
F101313	19	J13011	46	J2272	28	PC-OE-SE	35
F102213	19	J13011-TP-1	46	J2272-56	28	PC-OS-MAM	35
F102313	19	J13012	46	J2272-58	28	PMFLD	4
F1025	48	J13069	7	J2274	33	Q	50
F1330	42	J13514	32	J2274-56	33	R	50
F1330-IN	42	J13516	32	J2431	7	SLH-BL	29
F1331	42	J13524	32	J2441	7	SLH-CA	29
F1332-NF	42	J13526	32	J2441-W	32	SLH-GR	29
F1346	44	J13534	32	J6480	51	SLH-PI	29
F1347	44	J13536	32	J0501	48	SLH-PU	29
F1421	45	J13994	27	K	49	SLH-SC	29
F1421-IN	45	J13994-G	27	KA-2510003	17	SLH-TA	29
F1422	45	J13994-R	27	KA-2510004	17	TAB-DIV-ST1	37
F1422-IN	45	J13996	27	KA-2510004/3/2Scored	17	TAB-DIV-ST1-SE	37
F1423	45	J13996-B	27	KA-2510005	17	TAB-MR	37
F1423-IN	45	J13997	27	KA-2520003	17	TAB-VNA	37
F1711	22	J13997-B	27	KA-2520004	17		
F1712	22	J13998	27	KA-2520004/3/2S	17		
F1721	22	J13998-B	27	KA-2610002	16		
F1722	22	J13999	27	KA-2610003R	16		
F1751	22	J13999-B	27	KA-2610004R	16		

Index – Labels

MODEL NO.	PAGE	MODEL NO.	PAGE	MODEL NO.	PAGE	MODEL NO.	PAGE
00**	75	5807	69	ALLERGY Large	69	Series 7300 (GBS)	63
1114	69	5808	69	ALLERGY Small	69	Series 7400 (GBS)	63
1207-*	54	6304-00/CLCOM	53	DF737-**	70	Series 7500 (Jeter)	55
1207-50	54	6304-20	53	GBS Color Control	59	Series 7600 (Jeter)	65
1274-DBL	77	6307-00/CLCOM	53	L-A-**134	66	Series 7700 (Jeter)	56
1274-SGL	77	6321-00/CLCOM	53	L-A-**134RB	62	Series 7700-R (GBS)	63
1277-*	60	6321-HA/CLCOM	53	L-A-**178	66	Series 8000 (Jeter)	64
1277-50	60	6321-HA50/CLCOM	53	L-A-**178RLP	62	Series 8800 (Jeter)	64
1278-*	54	6324-00/CLCOM	53	L-A-**178RS	62	Series 8900 (Jeter)	56
1278-50	54	6324-HA/CLCOM	53	L-A-DD**R134	73	Series 9000 (Jeter)	64
1279-**	72	6324-HA50/CLCOM	53	L-A-DD**R178	73	Series 9000	64
1279-50	72	6352-00	53	L-A-M***	76	Series 9500 (Jeter)	69
1280-*	61	6376-00/CLCOM	53	L-A-MY***19	76	Series 9600 (Jeter)	65
1280-50	61	6376-50/CLCOM	53	L-A-MY***20	76	Series 9700 (Jeter)	65
1281-**	66	6378-00/CLCOM	53	L-A-MY***21	76	Series L-A-ALPHA (AMES)	57
1281-50	66	6379-00/CLCOM	53	L-A-MY***22	76	Series L178 (AMES)	57
1282-*	60	6379-50/CLCOM	53	L-A-MY***23	76		
1282-50	60	6380-00/CLCOM	53	L-A-ST134	66		
1283-*	54	6381-00/CLCOM	53	L-A-ST178	66		
1283-50	54	6384-00/CLCOM	53	L-T-ALPHA-F	54		
1286-*	54	6384-50/CLCOM	53	L-T-ALPHA-MC	54		
1286-00	54	6400-00/CLCOM	53	L-T-ALPHA-O	54		
1287-**	71	6403-00/CLCOM	53	L7600-*	67		
1303-00	68	6405-00/CLCOM	53	L7700-*	61		
1306-*	60	6408-00/CLCOM	53	L7701-*	55		
1306-50	60	6408-50/CLCOM	53	L7704	55		
1307-*	54	6410-00/CLCOM	53	L8700-*	61		
1307-50	54	6412-00/CLCOM	53	L8706	61		
1308-**	71	6413-00/CLCOM	53	L8720-*	55		
1309-**	71	6414-00	53	L8724	55		
1389-00	68	6414-00	53	L8800-**	71		
1390-00	68	6443-00/CLCOM	53	L8801-**	72		
1394-00	68	6444-00	53	LZR-Label	68		
1396-00	68	6445-00/CLCOM	53	PRIVACY	69		
1397-00	68	6446-00/CLCOM	53	Series 0100 (Jeter)	64		
1398-00	68	6447-00/CLCOM	53	Series 0300 (GBS)	63		
1401-00	68	70**	75	Series 2500 (GBS)	58		
1735	67	7106	69	Series 2600 (GBS)	63		
1820	68	7107	69	Series 2800 (GBS)	58		
1821	68	7108	69	Series 2900 (GBS)	58		
1835	67	75**YB	74	Series 3000 (GBS)	63		
1851	68	8816-*	73	Series 4500 (Jeter)	64		
1935	67	8848-*	59	Series 4600	65		
20**YB-A	74	8850-*	59	Series 5100 (GBS)	58		
20**YB-R	74	8851-**	73	Series 5200 (GBS)	59		
20**YB	74	8853-G	77	Series 5300 (Jeter)	64		
20**YBAX	75	8941	77	Series 5300 (Jeter)	69		
2035-100	67	8960CL	53	Series 5400 (Jeter)	59		
2035	67	8961CL	53	Series 5800 (Jeter)	56		
224**MY	74	8962CL	53	Series 6200 (Jeter)	67		
25**YB	74	8964CL	53	Series 6300 (Jeter)	67		
58**YB	74	8965CL	53	Series 7100 (Jeter)	56		
5806	69	8968CL	53	Series 7200 (Jeter)	56		

Easy Order Planner



It's easy! Check below for all your regular TAB products then call us at **1-888-466.8228** and you'll receive instant confirmation of stock and total order price. You can also mail to TAB EXPRESS, 605 Fourth St. Mayville, WI 53050 OR e-mail cspaper@tab.com

Now you can order online at shoptab.com

BILL TO

Customer No.: _____
 Taxable: Yes No Tax Exempt No.: _____
 Company: _____
 Attention: _____
 Address/P.O. Box: _____
 City: _____ State: _____ Zip: _____
 Office Phone: (_____) _____
 Email: _____

SHIP TO

Company: _____
 Attention: _____
 Address/P.O. Box: _____
 City: _____ State: _____ Zip: _____
 If we have questions, who should we ask for? _____
 Daytime Phone: (_____) _____
 Email: _____

Minimum order \$100.00



Solid Color Folder

Indicate number of folders (100/box)
 Letter Size _____ Legal Size _____
 _____ 1106- _____ 1126- _____

- Fill in blank with code:**
- 00 Goldenrod
 - 01 White
 - 02 Blue
 - 03 Green
 - 04 Gray
 - 05 Canary
 - 06 Orange
 - 07 Pink
 - 08 Red
 - 09 Lavender

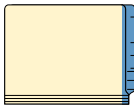

Color End Tab Folder

Indicate number of folders (100/box)
 Letter Size _____ Legal Size _____
 _____ 1162- _____ 1163- _____



Manila Folder

Letter Size _____ Legal Size _____
 _____ 1103-50 11pt. _____ 1105-50 11pt.
 _____ 1123 14pt. _____ 1127 14pt.



Pressboard Folder

Letter Size _____ 1236 25pt. gray
 _____ 1236- _____ 20pt.*
 Legal Size _____ 1251 25pt. gray
 _____ 1251- _____ 20pt.*

- Fill in blank with code:**
 *Refer to page 12 for available colors.

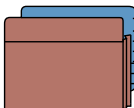

Expansion Pockets

Letter / 13/4" _____ 1187- _____ red front
 _____ 1378- _____ color front*
 Letter / 3 1/2" _____ 1189- _____ red front
 _____ 1379- _____ color front*
 Legal / 13/4" _____ 1191- _____ red front
 _____ 1380- _____ color front*
 Legal / 3 1/2" _____ 1193- _____ red front
 _____ 1381- _____ color front*

- Fill in blank with code:**
- 11 Manila
 - 50 Goldenrod
 - 51 White
 - 52 Blue
 - 53 Green
 - 54 Gray
 - 55 Canary
 - 56 Orange
 - 57 Pink
 - 58 Red
 - 59 Lavender

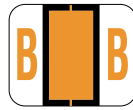

Alphabetic Labels

Each box contains 500 of the same labels.
 Indicate the quantity of boxes for each letter ordered.

_____ 1283-A	_____ 1283-H	_____ 1283-O	_____ 1283-V
_____ 1283-B	_____ 1283-I	_____ 1283-P	_____ 1283-W
_____ 1283-C	_____ 1283-J	_____ 1283-G	_____ 1283-X
_____ 1283-D	_____ 1283-K	_____ 1283-R	_____ 1283-Y
_____ 1283-E	_____ 1283-L	_____ 1283-S	_____ 1283-Z
_____ 1283-F	_____ 1283-M	_____ 1283-T	_____ 1283-Mc
_____ 1283-G	_____ 1283-N	_____ 1283-U	_____ 1283-50

(Alpha set)



Numeric Labels

Each box contains 500 of the same labels.

_____ 1282-01	_____ 1282-05	_____ 1282-09
_____ 1282-02	_____ 1282-06	_____ 1282-00
_____ 1282-03	_____ 1282-07	_____ 1282-50
_____ 1282-04	_____ 1282-08	(Complete set)



Year Code Labels

Each box contains 500 of the same labels.

_____ 1287-20	_____ 1287-24	_____ 1287-28	_____ 1287-32
_____ 1287-21	_____ 1287-25	_____ 1287-29	_____ 1287-33
_____ 1287-22	_____ 1287-26	_____ 1287-30	_____ 1287-34
_____ 1287-23	_____ 1287-27	_____ 1287-31	_____ 1287-35



TABSTIK Labels

Each package contains 504 of the same labels.

_____ 1389 Dark Green	_____ 1394 Red	_____ 1397 Dark Blue
_____ 1390 White	_____ 1396 Purple	_____ 1398 Light Blue
		_____ 1401 Tan



Self-Adhesive Fasteners

Each box contains 100 fasteners.

_____ 1108-00 2" Self-adhesive fastener

USE THIS TO ORDER ADDITIONAL ITEMS NOT SHOWN:

Model No.	Color	Quantity	Description	Price Each	Total
Signature: _____				Order Total: _____	

Customize your folders!

TRUST **TAB** TO SAVE YOU **TIME** AND **MONEY**.

Custom short run printing

Custom dividers

Custom printed labels

Custom indexes & filebacks

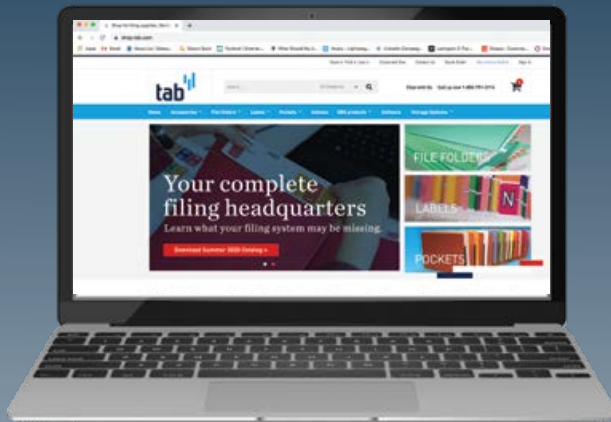

TAB2025

Easy online ordering!

- Quick and simple sign-up
- Re-order past supplies with easy re-order feature
- Only a click away from the filing supplies you need

USA – shoptab.com or shopjetersystems.com CANADA – shoptab.ca



605 Fourth Street, Mayville, WI 53050

1.888.466.8228 cspaper@tab.com shoptab.com